



CHEVROLET SILVERADO 1500

4th Gen 2019+ Predator & Toro Front Bar

Fitting Instruction







IMPORTANT! – READ BEFORE INSTALLATION

- When installed in accordance with these instructions, the front protection bar does not affect the operation of the vehicles SRS airbags.
- This product must be installed exactly as per these instructions using only hardware supplied.
- Take a few moments to read instructions thoroughly before beginning work.
- In the event of damage to any bar component please contact OFFROAD ANIMAL to arrange repair/replacement of components.
- Do not use this product for any vehicle make or model other than that specified on these instructions.
- Do not remove labels from this product.
- This product and its fixings must not be modified in any way unless stated in these fitting instructions.
- The installation of this product is recommended for trained personnel.
- These instructions are correct at time of publication. OFFROAD ANIMAL cannot be held responsible for the impact of any changes subsequently made by the vehicle manufacturer. If you find something has changed, please contact us to let us know!
- During installation it is the duty of the installer to check correct operation/clearances of all components.
- If Instructions are to be printed for reference in the workshop, it is recommended that they are printed in colour, for best legibility.

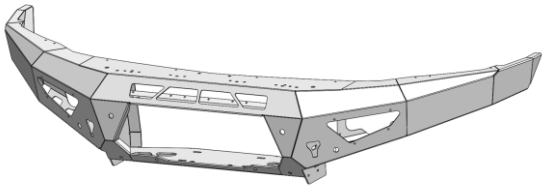
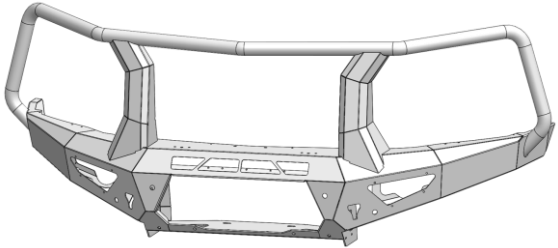
PARTS LISTING

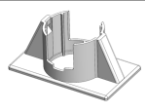
IMPORTANT: Check all parts are present before beginning work! Contact OFFROAD ANIMAL if something is missing.





Parts – In the Main Box

Qty	Part Number	Description	Image
1	FB-S15-T1-20-PR-ASM1	Silverado 1500 Predator Bar Welded Assembly	
OR			
1	FB-S15-T1-20-TOR-ASM1	Silverado 1500 Toro Bar Welded Assembly	
4	CPHP029	Plastic Hole Insert, 17.4MM, Black, Tigerlink Hardware CPHP029	
4	F-0015	Chevrolet/Jeep Sensor Holder – Straight	
1	FB-S15-T1-20-PR-ADRCP	ADR Compliance Plate Silverado 1500	
1	OFA-LOGO	Offroad Animal Metal Logo	
1	TK-COM-PSEN-4	Tape Kit – 4 Sensor Universal	

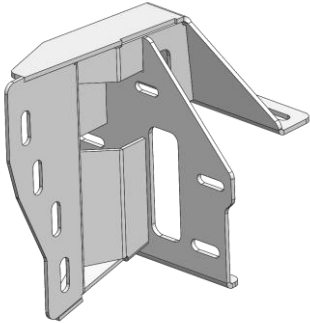
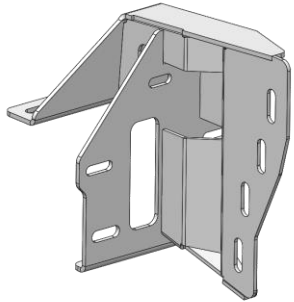
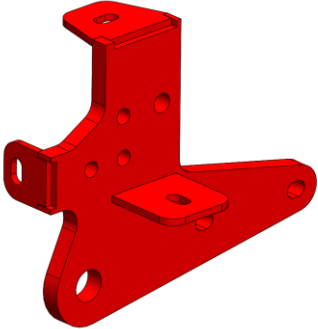
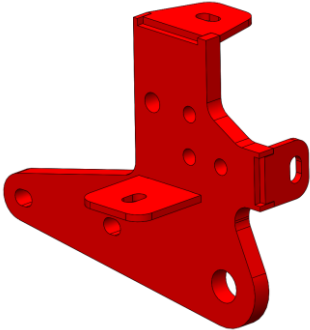

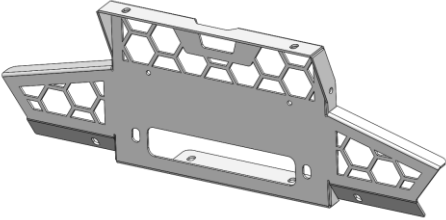
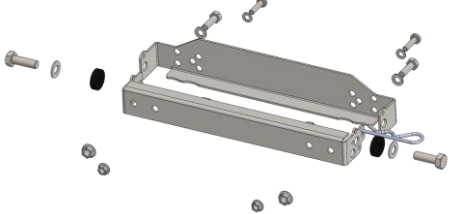
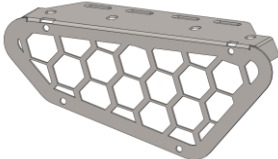
2	TK-FB-FRA-NG-22	Tape Kit – Next Gen Ranger Front Bar	
---	-----------------	--------------------------------------	--

Parts – In the Fitting Kit Box

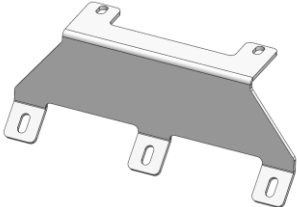
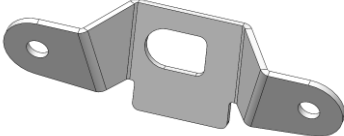
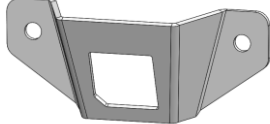
Qty	Part Number	Description	Image
1	FB-S15-T1-20-PR-ASM2R	Silverado 1500 Impact Assembly	
1	FB-S15-T1-20-PR-ASM2L	Silverado 1500 Impact Assembly	
1	FB-S15-T1-20-PR-ASM3R	Silverado 1500 Tow Point Assy	
1	FB-S15-T1-20-PR-ASM3L	Silverado 1500 Tow Point Assy	

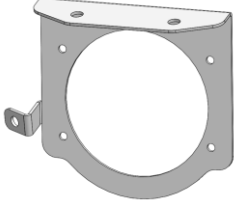
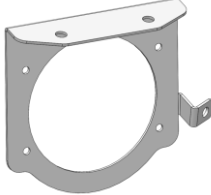
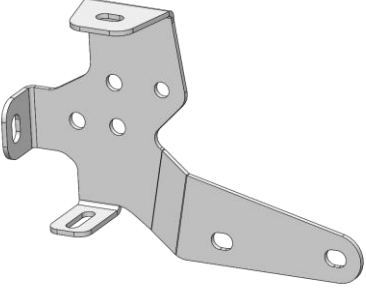
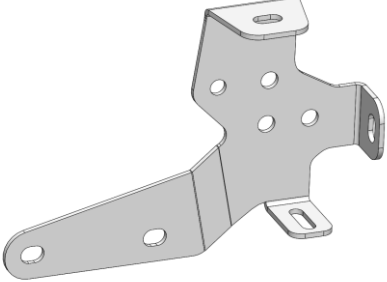
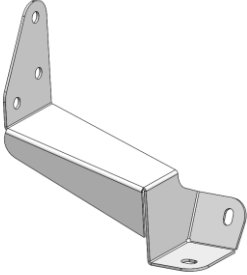
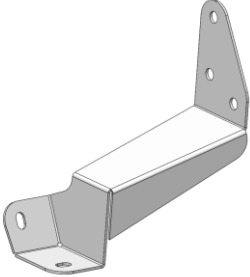
1	FB-S15-T1-20-PR-ASM4	Silverado 1500 Mesh Fairlead Assy	
1	NPF-COM-SM-ASM0	Number Plate Flip ASM Small	
1	M-0002R	Light Cover Mesh	
1	M-0002L	Light Cover Mesh	
1	B-0857R	Silverado 1500 Winch Strap	
1	B-0857L	Silverado 1500 Winch Strap	
1	B-0858	Silverado 1500 Pan Brace	
1	B-0859	Silverado 1500 Pre-Facelift 360 Camera Backing Plate	
1	B-0860	Silverado 1500 Pre-Facelift 360 Camera Mount	

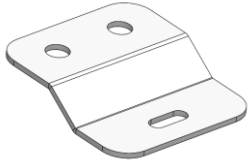
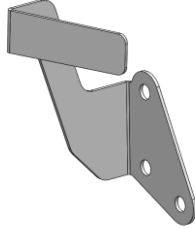
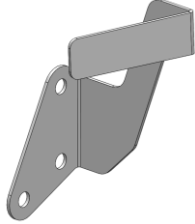
<p>1</p>	<p>B-0861R</p>	<p>Silverado 1500 Halo Fog Light Bracket</p>	
<p>1</p>	<p>B-0861L</p>	<p>Silverado 1500 Halo Fog Light Bracket</p>	
<p>1</p>	<p>B-0862R</p>	<p>Silverado 1500 Front Mount Chassis Brace</p>	
<p>1</p>	<p>B-0862L</p>	<p>Silverado 1500 Front Mount Chassis Brace</p>	
<p>1</p>	<p>B-0866R</p>	<p>Silverado 1500 Headlight Bracket</p>	
<p>1</p>	<p>B-0866L</p>	<p>Silverado 1500 Headlight Bracket</p>	

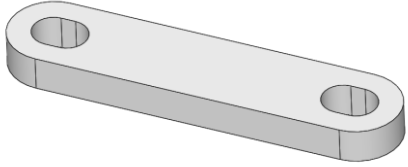
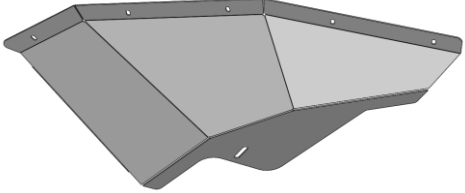
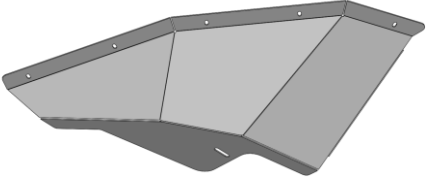
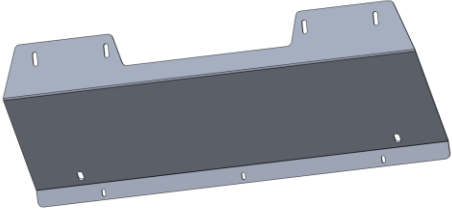
2	B-0867	Silverado 1500 Side Underpanel Mount Bracket	
1	B-0942R	Bumper Winglet Support	
1	B-0942L	Bumper Winglet Support	
6	P-0024	Ranger Tow Point Spacer	
2	P-0278	Silverado 1500 Tow Point Rear Spacer Plate	
1	U-0064R	Silverado 1500 Side Underpanel	
1	U-0064L	Silverado 1500 Side Underpanel	
1	U-0065	Silverado 1500 Bash Plate	

<p>1</p>	<p>U-0066</p>	<p>Silverado 1500 Lower Base Plate</p>	
<p>TORO BAR ONLY</p>			
<p>2</p>	<p>B-0649</p>	<p>Toro Antenna Bracket – 90 Degree Tall</p>	

PREDATOR Fasteners – Contained in Small Parts Kit Bag

Qty	Part Number	Description
8	M4x12 PAN	SCREW, PAN HEAD PHILLIPS, M4X12X0.7 GR4.6 ZP
8	M4 FLAT WASHER	Flat Washer M4, 8mmODx0.8mm T
8	M4 FLANGE NUT	Flange Nut, M4
4	M6 X 12 HEX	M6X12 HEX BOLT, ZP, 8.8
3	M6 X 20 HEX	M6X20 HEX BOLT, ZP, 8.8
25	M6x16 BHCS BLACK ZINC	SCREW, BUTTON HEAD CAP, M6X16X1 GR12.9, ISO4042 ZnNi BLACK PASSIVATED FINISH
7	M6 FLAT WASHER	M6 FW
25	M6 FLAT WASHER BLACK ZINC	M6 Flat Washer, 12x6.1x1, ISO4042 ZnNi BLACK PASSIVATED FINISH
22	M6 FLANGE NUT	Flange Nut, M6x1 G8.8 ZP
10	M6CN3MM	CAGE NUT M6x2.6-3.5
4	M8 X 12 HEX	Bolt Hex, M8X12x1.25, GR8.8 ZP
2	M8 X 20 HEX	Bolt Hex, M8X20x1.25, GR8.8 ZP
4	M8 X 16 BHCS BZP	SCREW, BUTTON HEAD CAP, M8X16X1.25 GR12.9, ISO4042 ZnNi BLACK PASSIVATED FINISH
4	M8 X 20 BHCS BLACK ZINC	SCREW, BUTTON HEAD CAP, M8X20X1.25, ISO4042 ZnNi BLACK PASSIVATED FINISH
4	M8 FLAT WASHER	M8 FW
2	M8 HD FLAT WASHER	M8 FLAT WASHER - High Tensile 19x8x1.9mm
8	M8 FLAT WASHER - BLACK ZINC	M8 FLAT WASHER, 16.5x8.4x1.2, ISO4042 ZnNi BLACK PASSIVATED FINISH
6	M8 FLANGE NUT	Flange Nut, M8x1.25 G8.8 ZP
4	M10 x 25	Bolt Hex, M10X25x[1.5], GR8.8 ZP
4	M10 FW LHD	WASHER, FLAT M10X28.5X2.5
4	M10 FLANGE NUT	Flange Nut, M10x1.5 G8.8 ZP
16	M12X30	Bolt Hex, M12X30x1.75, GR8.8 ZP
6	M12X120	Bolt Hex, M12X120x1.75, GR8.8 ZP
4	M12X130	Bolt Hex, M12X130x1.75, GR8.8 ZP
28	M12 FW LHD	M12 FW Large Heavy Duty
24	M12 FLANGE NUT	Flange Nut, M12x1.75 G8.8 ZP
2	M12 Nyloc nut	M12 NYLOC NUT
4	T-0060	Silverado 1500 Crush Tube 75mm
2	T-0061	Silverado 1500 Crush Tube 95mm
2	NP-COM-M10-190-SLIM	Nut Plate M10 Slim - Suit DMAX Predator
2	NP-COM-M12-300- ASM0	M12 NUT PLATE 300MM STEM

TORO Fasteners – Contained in Small Parts Kit Bag

Qty	Part Number	Description
8	M4x12 PAN	SCREW, PAN HEAD PHILLIPS, M4X12X0.7 GR4.6 ZP
8	M4 FLAT WASHER	Flat Washer M4, 8mmODx0.8mm T
8	M4 FLANGE NUT	Flange Nut, M4
4	M6 X 12 HEX	M6X12 HEX BOLT, ZP, 8.8
3	M6 X 20 HEX	M6X20 HEX BOLT, ZP, 8.8
25	M6x16 BHCS BLACK ZINC	SCREW, BUTTON HEAD CAP, M6X16X1 GR12.9, ISO4042 ZnNi BLACK PASSIVATED FINISH
7	M6 FLAT WASHER	M6 FW
25	M6 FLAT WASHER BLACK ZINC	M6 Flat Washer, 12x6.1x1, ISO4042 ZnNi BLACK PASSIVATED FINISH
22	M6 FLANGE NUT	Flange Nut, M6x1 G8.8 ZP
10	M6CN3MM	CAGE NUT M6x2.6-3.5
4	M8 X 12 HEX	Bolt Hex, M8X12x1.25, GR8.8 ZP
2	M8 X 20 HEX	Bolt Hex, M8X20x1.25, GR8.8 ZP
4	M8 X 16 BHCS BZP	SCREW, BUTTON HEAD CAP, M8X16X1.25 GR12.9, ISO4042 ZnNi BLACK PASSIVATED FINISH
8	M8 X 20 BHCS BLACK ZINC	SCREW, BUTTON HEAD CAP, M8X20X1.25, ISO4042 ZnNi BLACK PASSIVATED FINISH
4	M8 FLAT WASHER	M8 FW
2	M8 HD FLAT WASHER	M8 FLAT WASHER - High Tensile 19x8x1.9mm
12	M8 FLAT WASHER - BLACK ZINC	M8 FLAT WASHER, 16.5x8.4x1.2, ISO4042 ZnNi BLACK PASSIVATED FINISH
6	M8 FLANGE NUT	Flange Nut, M8x1.25 G8.8 ZP
4	M10 x 25	Bolt Hex, M10X25x[1.5], GR8.8 ZP
4	M10 FW LHD	WASHER, FLAT M10X28.5X2.5
4	M10 FLANGE NUT	Flange Nut, M10x1.5 G8.8 ZP
16	M12X30	Bolt Hex, M12X30x1.75, GR8.8 ZP
6	M12X120	Bolt Hex, M12X120x1.75, GR8.8 ZP
4	M12X130	Bolt Hex, M12X130x1.75, GR8.8 ZP
28	M12 FW LHD	M12 FW Large Heavy Duty
24	M12 FLANGE NUT	Flange Nut, M12x1.75 G8.8 ZP
2	M12 Nyloc nut	M12 NYLOC NUT
4	T-0060	Silverado 1500 Crush Tube 75mm
2	T-0061	Silverado 1500 Crush Tube 95mm
2	NP-COM-M10-190-SLIM	Nut Plate M10 Slim - Suit DMAX Predator
2	NP-COM-M12-300- ASM0	M12 NUT PLATE 300MM STEM

TOOLS REQUIRED

The following tools will be required to install the product.

Hand Tools	Power Tools	Workshop Equipment
Metric Socket Set 10-19mm	Electric/Air Impact Driver (Optional)	Isopropyl Alcohol
Socket Extension Bar	Air Hacksaw	Rag
Metric Spanner Set 10-19mm	or	Cable Ties
Hex (Allen) Key Set 4-6mm	Oscillating Multi Tool	Sandpaper
Torx Key Set	or	Automotive adhesive sealant (eg. Sikaflex)
Trim Removal Tool	Angle Grinder	
Plastic Auto Trim Tool Set	or	
Flat Blade Screwdriver Set	Jigsaw	
Phillips Head Screwdriver Set		
Utility Knife		
Side Cutters		
Pliers		

WORKSHOP SAFETY

It is the responsibility of the installer to always complete works in a safe manner. Make sure the following safety equipment is available and precautions are observed whilst fitting this product.

<p>Hearing Protection</p> 	<p>Always wear ear protection when using power tools.</p>
<p>Eye Protection</p> 	<p>Ensure eye protection is always worn when cutting or drilling.</p>
<p>Manual Handling</p> 	<p>Do not attempt to lift bar assemblies or rock sliders on your own.</p> <p>Always use two people to lift or use mechanical Lifting aid such as hydraulic lifting trolley.</p>
<p>Vehicle Support</p> 	<p>Always ensure vehicle is properly supported when working on it. Do not attempt to fit products whilst suspension work is being carried out. Do not work under a vehicle supported only by a jack.</p>



1. Open the bonnet.
2. Remove the bonnet release handle by unscrewing the 2x T15 Torx screws.

TOOLS REQUIRED

T15 Torx Driver

FASTENERS

2x T15 Torx screw

Retain for Reassembly

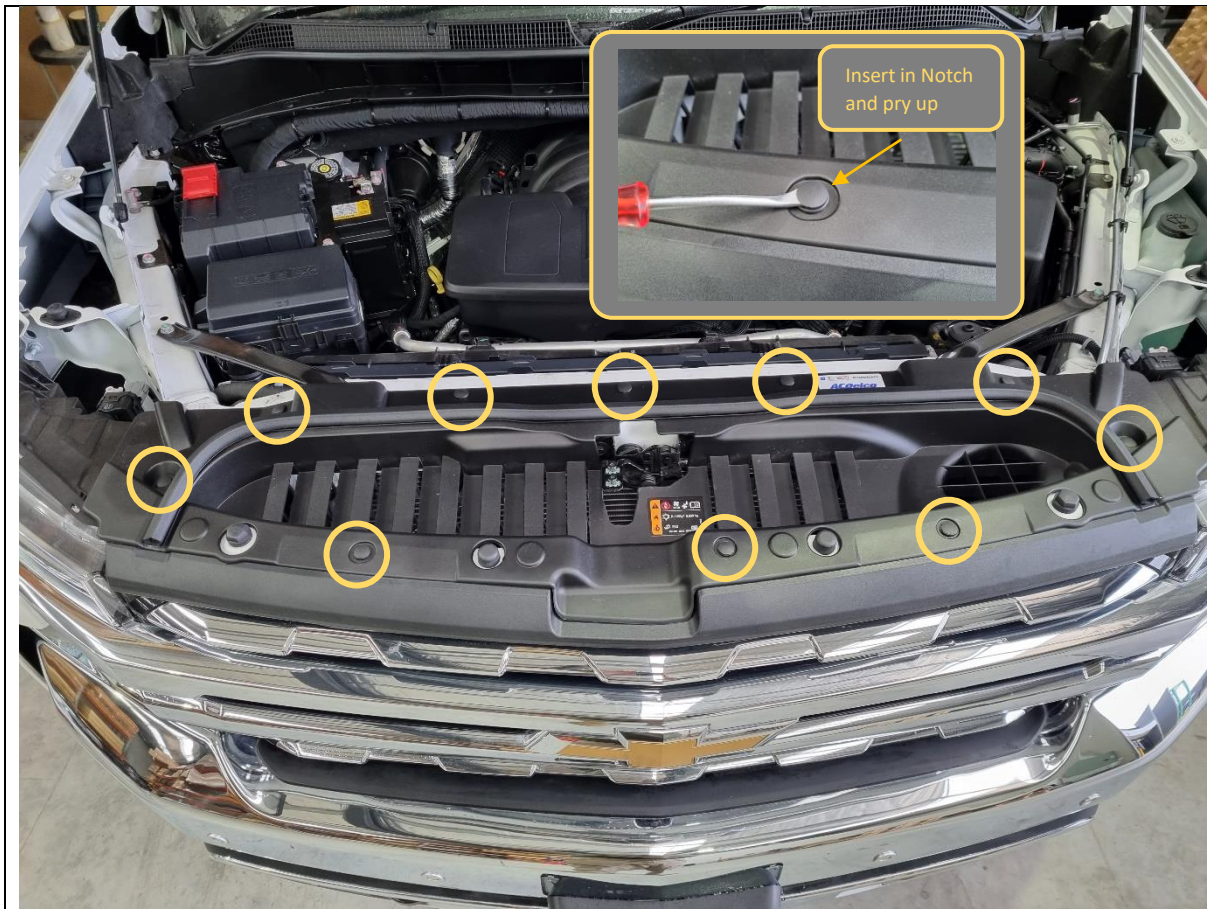

3. Remove 10x plastic push rivets securing the radiator grille cover, by levering centre section upwards using flat bladed screwdriver or trim tool, as shown.

TOOLS REQUIRED

Flat Blade Screwdriver or
Trim Tool

FASTENERS

10x Plastic Push Rivet
Retain for Reassembly



4. Remove 4x 10mm hex bolts on the top edge of the grille.

TOOLS REQUIRED

10mm socket

FASTENERS

4x 10mm hex bolt

Retain for Reassembly



5. The grille is held in place with plastic clips throughout.

Insert a plastic trim removal tool under the side at the headlight and gently release the first clip.
6. Continue working around the grille to release most of the clips, either with the plastic trim tool or by pulling the grille outwards.

TOOLS REQUIRED

Plastic trim tool

FASTENERS



7. If a front camera is equipped, disconnect the coaxial cable behind the grille on the LH side.
8. Once all cables are disconnected, fully remove the grille and set aside.

TOOLS REQUIRED

FASTENERS



- 9. Remove 5x T15 Torx screws securing the wheel arch liner to the bumper.
- 10. Repeat for the other side.

TOOLS REQUIRED

T15 Torx Driver

FASTENERS

10x T15 screw

Retain for Reassembly

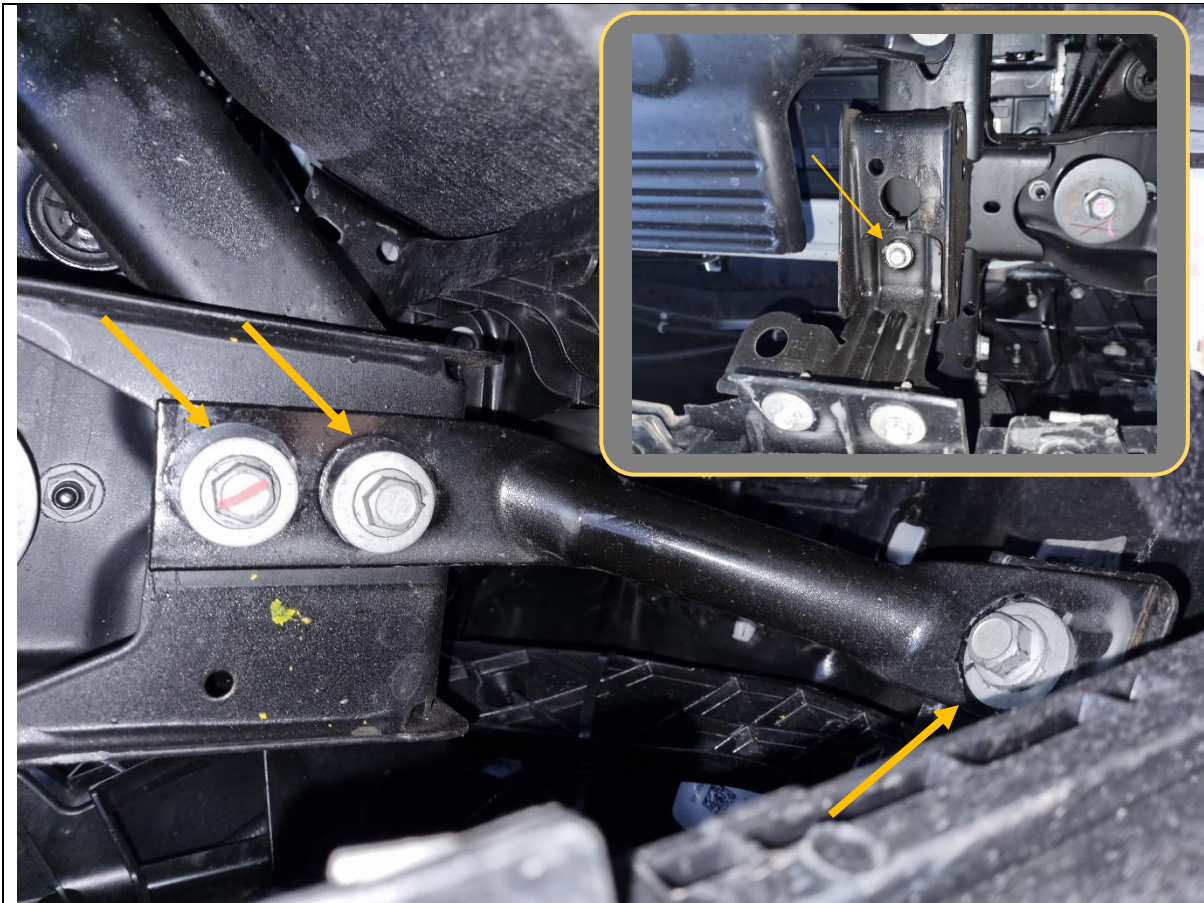

11. From underneath the vehicle, remove the 3x 15mm hex bolts (M10x35) for the outer bumper support bracket. Retain bolts for re-use later.
12. Remove the 10mm hex bolt for the middle bumper support bracket.
13. Repeat for the other side.

TOOLS REQUIRED

15mm socket
10mm socket

FASTENERS

6x M10x35 hex bolt
2x 10mm hex bolt

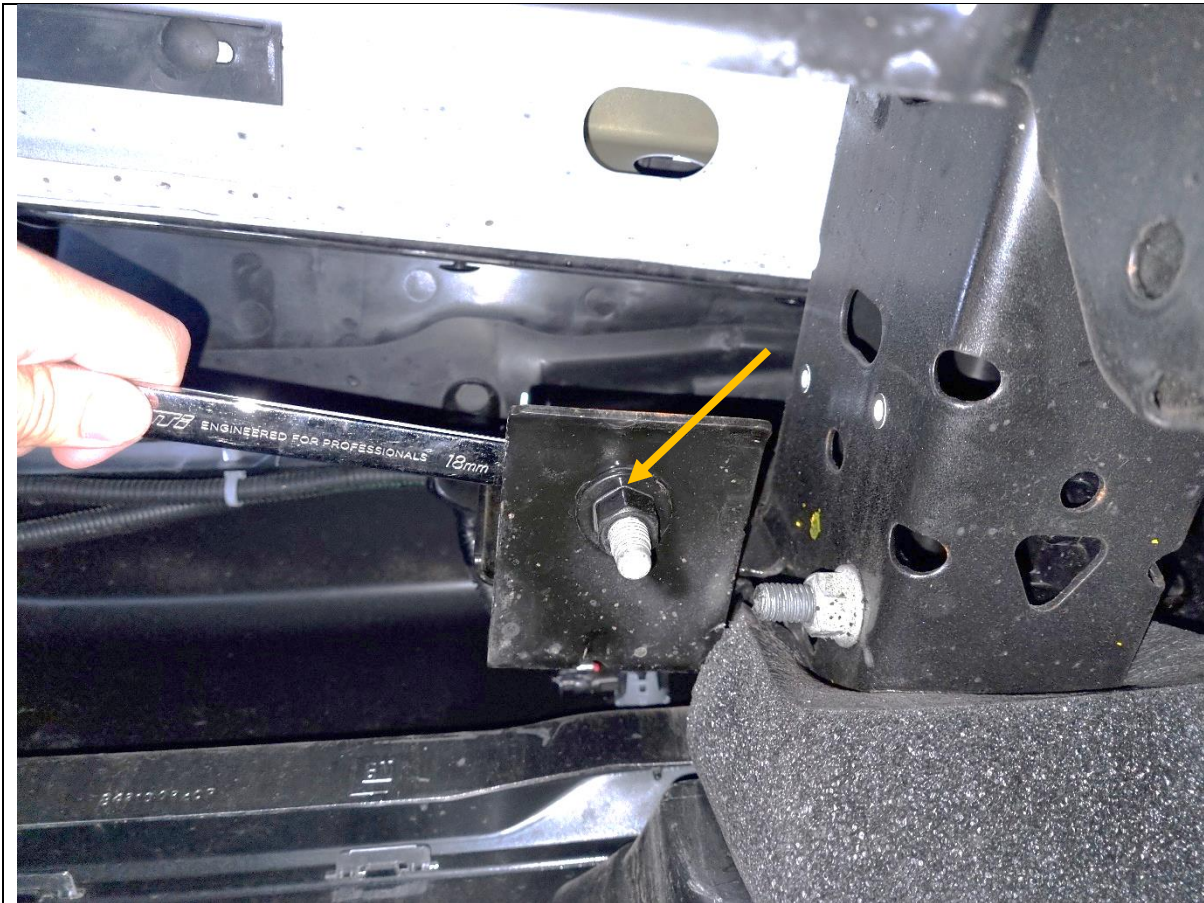

14. Above the middle bumper support bracket on the inside face of the chassis rail will be an 18mm hex bolt.

Remove the 18mm hex bolt with a spanner.

15. Repeat for the other side.

TOOLS REQUIRED

18mm spanner

FASTENERS

2x 18mm hex bolt



16. On the top lip of the bumper, there are 2x hex bolts hidden behind a rubber cover panel.

Remove the 13mm and 18mm hex bolts securing the bumper to the chassis.

17. Repeat for the other side.

TOOLS REQUIRED

13mm socket
18mm socket
Socket extension

FASTENERS

2x 13mm hex bolt
2x 18mm hex bolt



18. Support the bumper and pull outwards from the vehicle.
19. If equipped, disconnect the fog light and parking sensor loom on the driver side underneath the headlight (RH for Aus, LH for US vehicles).
20. Fully remove the bumper and set aside.

TOOLS REQUIRED**FASTENERS**



21. Remove the 3x 15mm hex bolts (M10x35) securing the bumper bracket to the chassis. Retain bolts for re-use.
22. Repeat on other side.

TOOLS REQUIRED

15mm socket

FASTENERS

6x M10x35 hex bolt
Retain for Reassembly



- 23. Remove the 2x 18mm hex bolts (M12x40) securing the tow hook to the chassis. Retain bolts for re-use.
- 24. Repeat for the other tow hook.

TOOLS REQUIRED

18mm socket

FASTENERS

4x M12x40 hex bolt
Retain for Reassembly

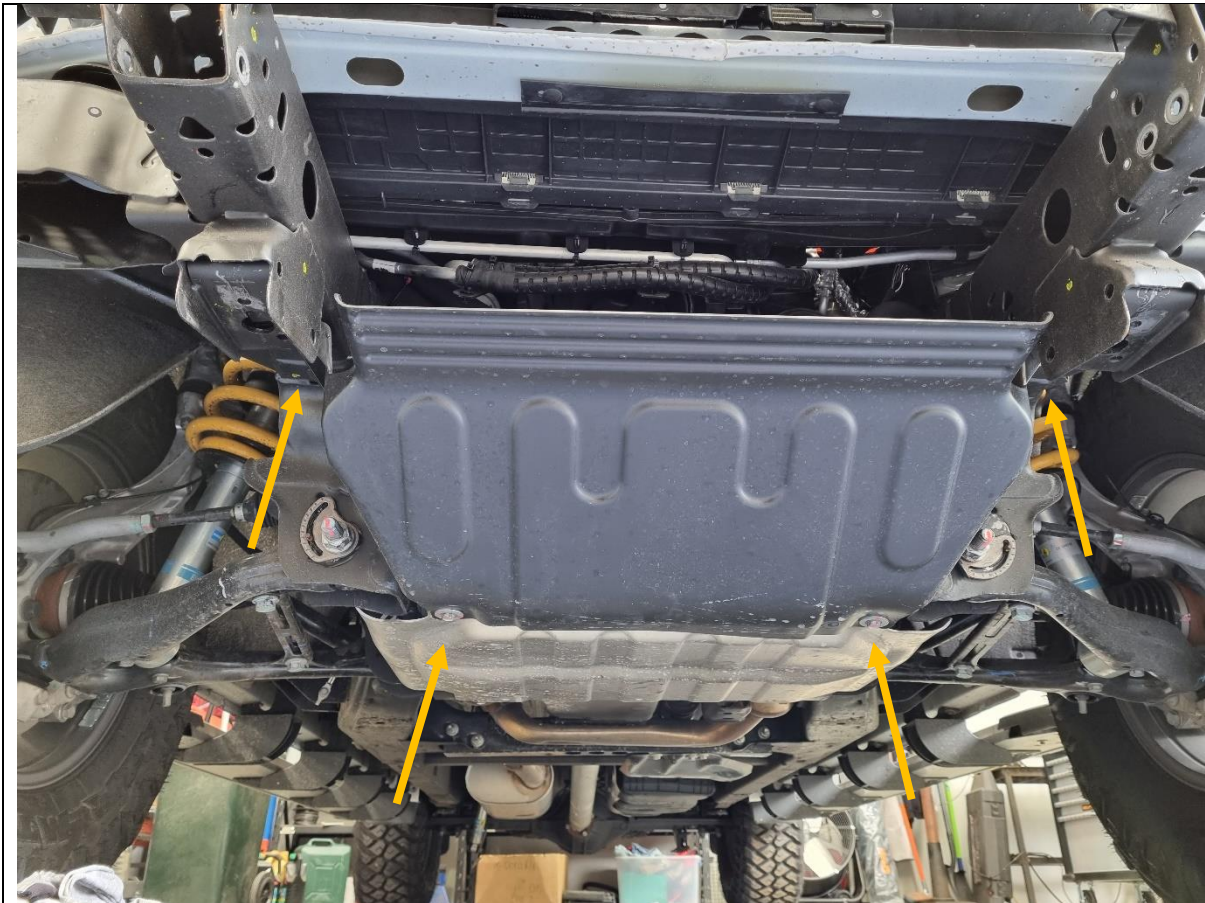

25. Remove the 4x 13mm hex bolts securing the underpanel to the chassis. Retain bolts for re-use.

TOOLS REQUIRED

13mm socket

FASTENERS

4x 13mm hex bolt

Retain for Reassembly

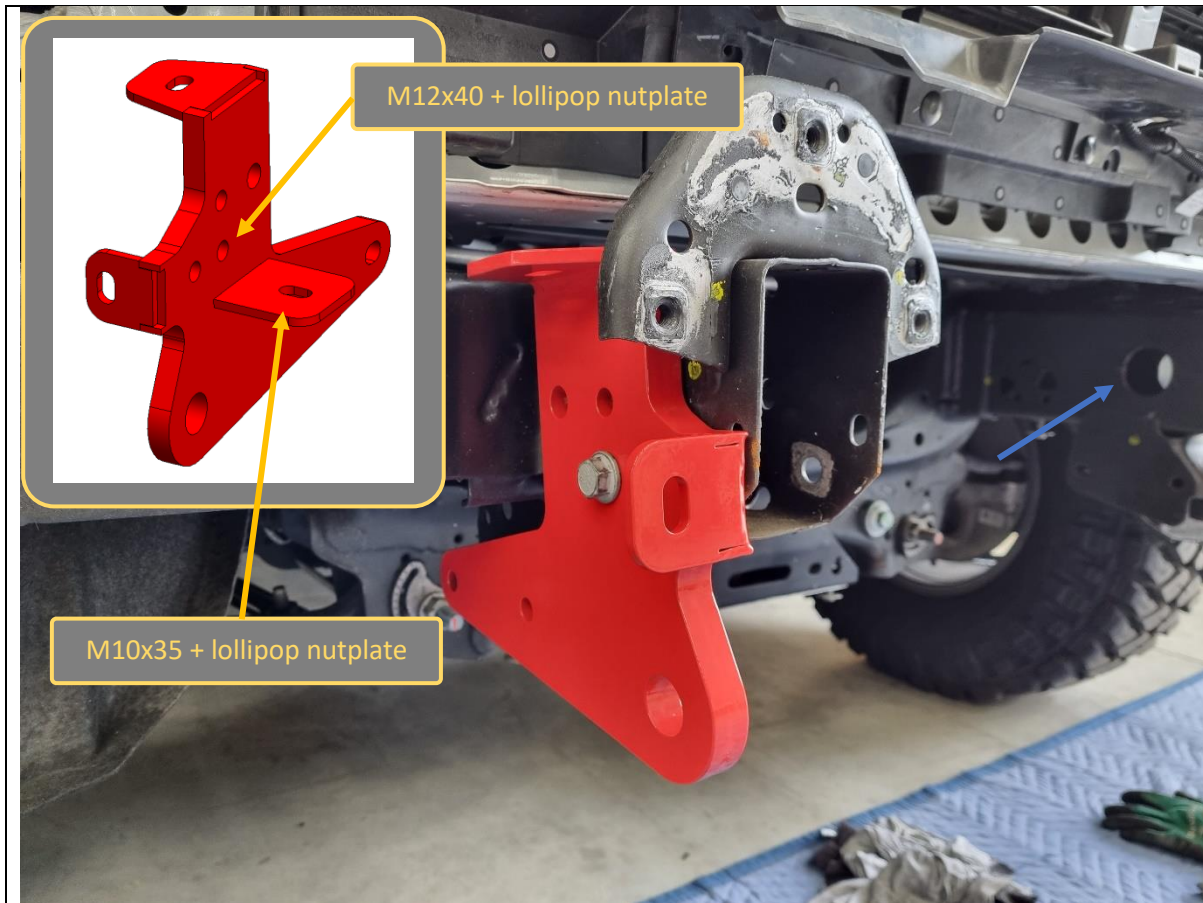

26. Fit the RH tow point to the vehicle using the retained factory M12x40 hex bolt (from Step 23) + M12 nutplate on the side and factory M10x35 hex bolt (from Step 11) + M10 nutplate on the bottom.

The lollipop nutplates can be insert through the open hole on the inside of the chassis (see blue arrow for reference).

TOOLS REQUIRED

15mm socket
18mm socket

FASTENERS

1x factory M10x35 hex bolt
1x M10 lollipop nutplate

1x factory M12x40 hex bolt
1x M12 lollipop nutplate

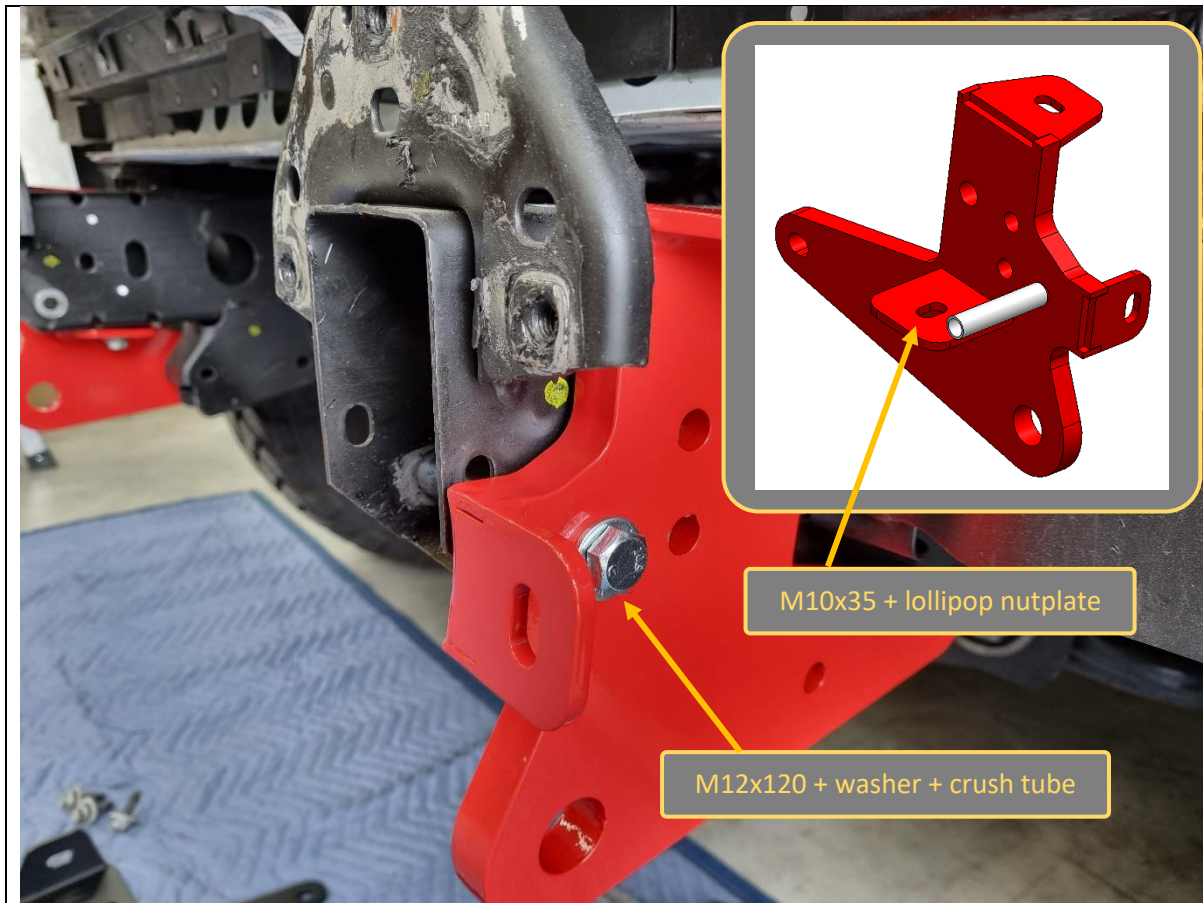

27. Fit the LH tow point to the vehicle using the retained factory M10x35 hex bolt (from Step 11) + M10 nutplate on the bottom.
28. Also loosely fit the tow point in place using 1x M12x120, flat washer and 75mm crush tube through the side. Do not secure with nut yet.

TOOLS REQUIRED

15mm socket
18/19mm socket

FASTENERS

1x factory M10x35 hex bolt
1x M10 lollipop nutplate

1x M12x120 hex bolt
1x M12 flat washer
1x 75mm crush tube

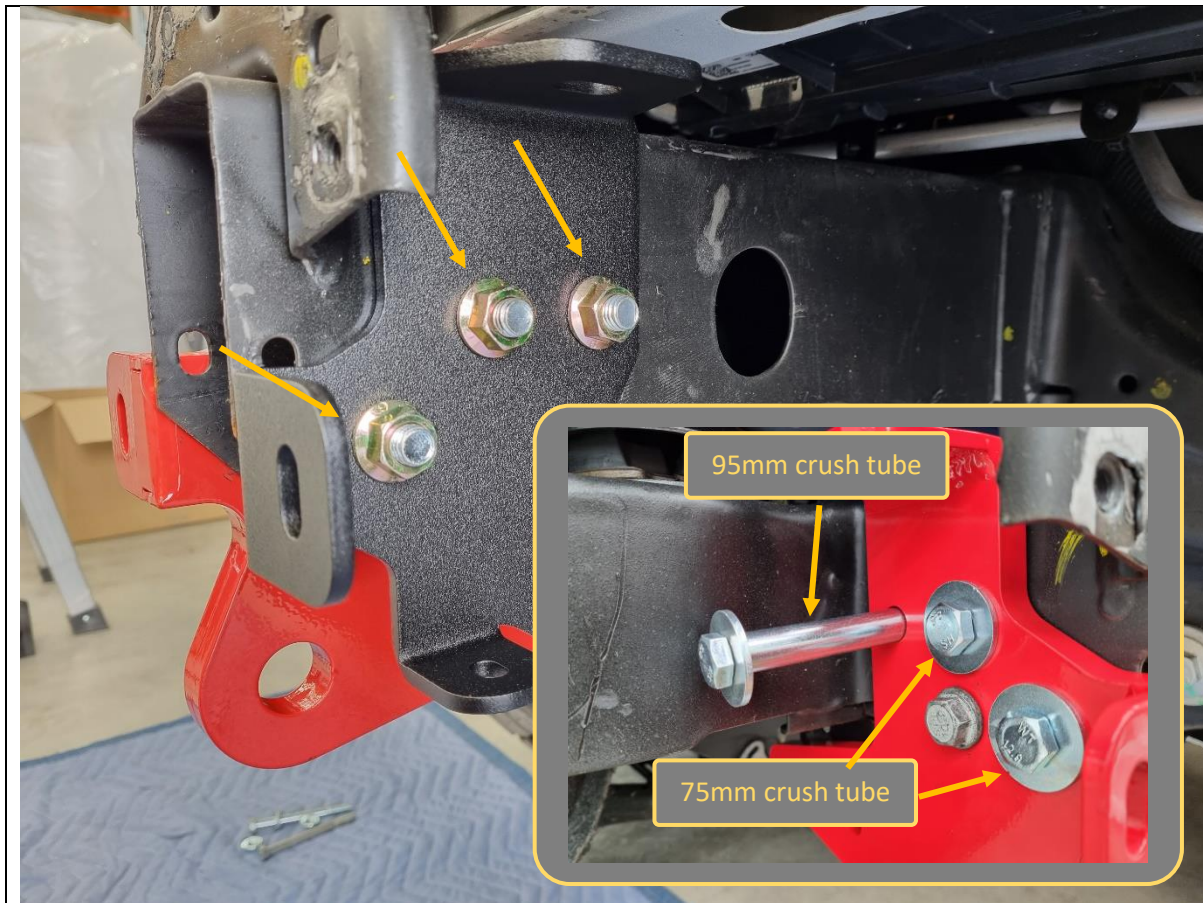

29. Fit the RH chassis mount brace bracket to the inside of the RH chassis rail and secure with 3x M12x120 hex bolt, 3x flat washer, 2x 75mm crush tube, 1x 95mm crush tube and 3x flange nut.

TOOLS REQUIRED

18/19mm socket

FASTENERS

3x M12x120 hex bolt
3x M12 flat washer
2x 75mm crush tube
1x 95mm crush tube
3x M12 flange nuts

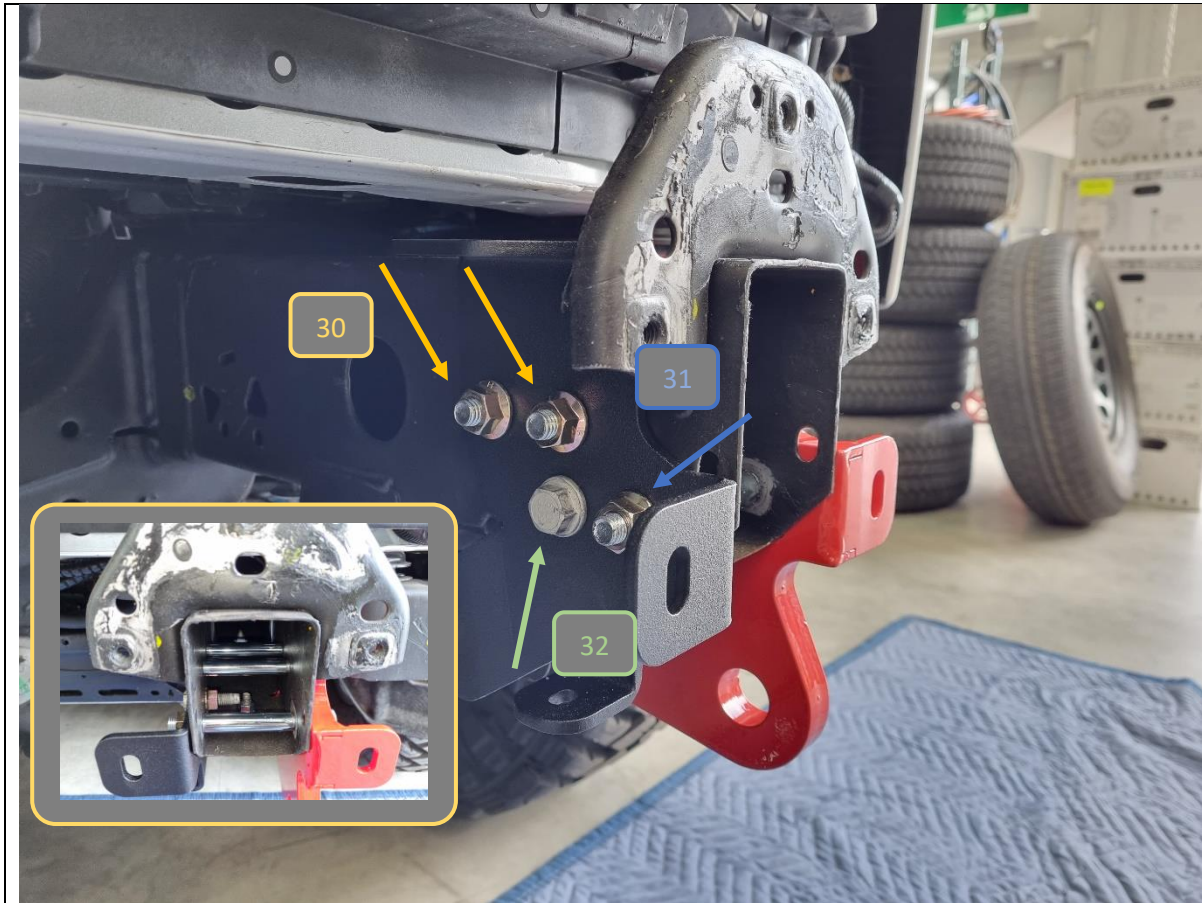

- 30. Fit the LH chassis mount brace bracket to the inside of the LH chassis rail and secure with 2x M12x120 hex bolt, 2x flat washer, 1x 75mm crush tube, 1x 95mm crush tube and 2x flange nut.
- 31. Secure the loose M12x120 from Step 28 with an M12 flange nut.
- 32. Fit the retained factory M12x40 hex bolt (from Step 24) + M12 nutplate on the side.

TOOLS REQUIRED

18/19mm socket

FASTENERS

2x M12x120 hex bolt
2x M12 flat washer
1x 75mm crush tube
1x 95mm crush tube
3x M12 flange nuts

1x factory M12x40 hex bolt
1x M12 lollipop nutplate

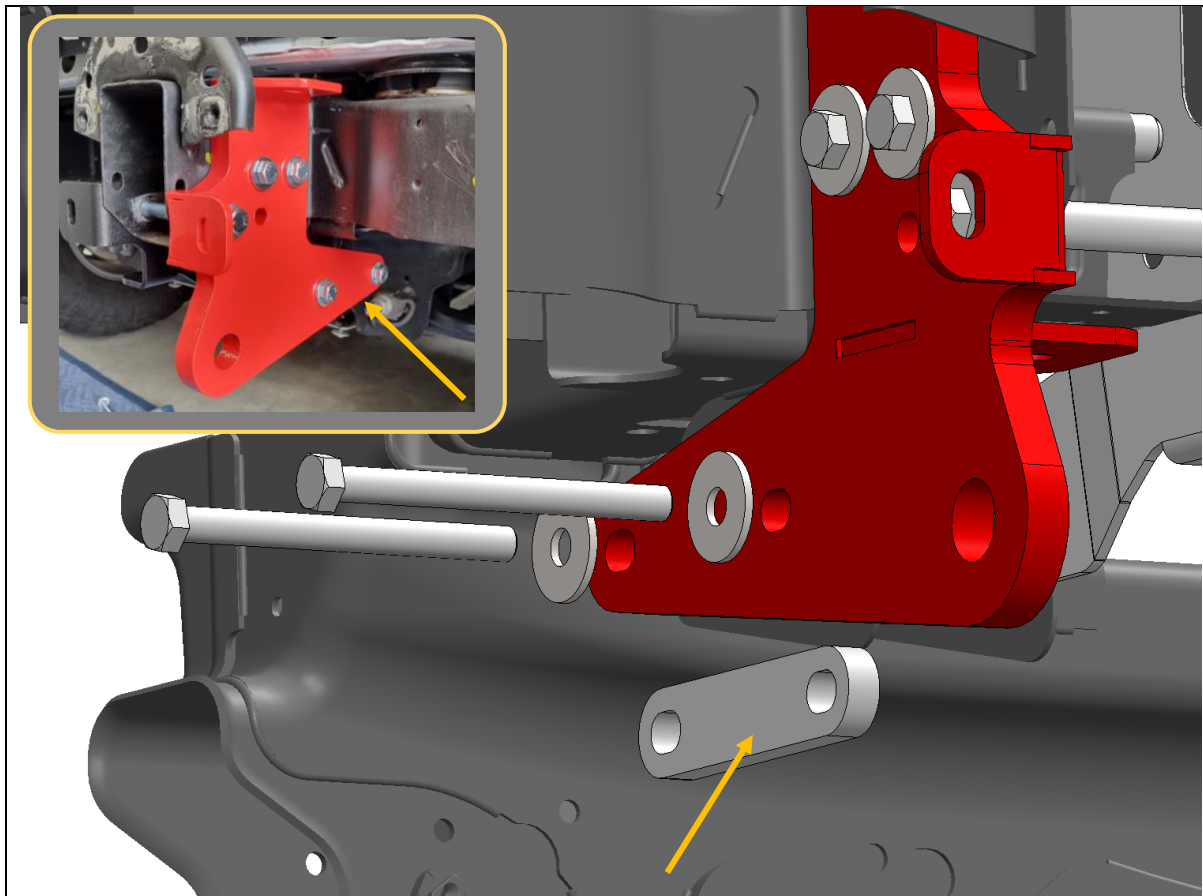

33. Insert the rear tow point spacer plate between the tow point and chassis at the rear, then loosely secure with 2x M12x130 hex bolts, flat washers and flange nuts.

Keep bolts finger tight at this stage.

34. Tighten all other fasteners in the tow point and chassis mount brace bracket, except for those 2x rear bolts.

35. Repeat for the LHS tow point.

TOOLS REQUIRED

15mm socket
18/19mm socket

FASTENERS

2x M12x130 hex bolt
2x M12 flat washer
2x M12 flange nuts

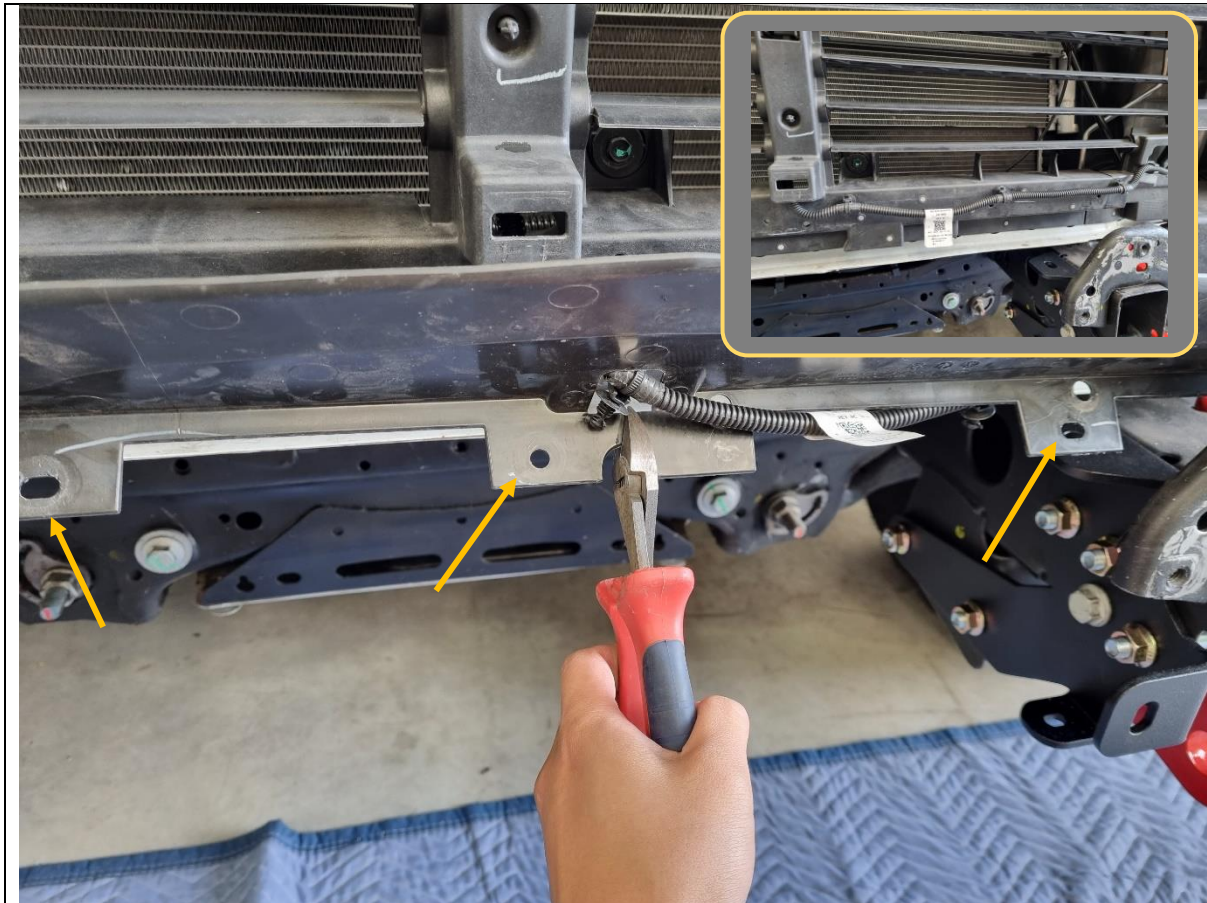

- 36. Remove the plastic push rivets securing the lower plastic air dam.
- 37. Unclip the wiring loom from the air dam, and then reclip the loom to the radiator louvre plastic frame, without the air dam.

TOOLS REQUIRED

Flat Blade Screwdriver or
Trim Tool

FASTENERS

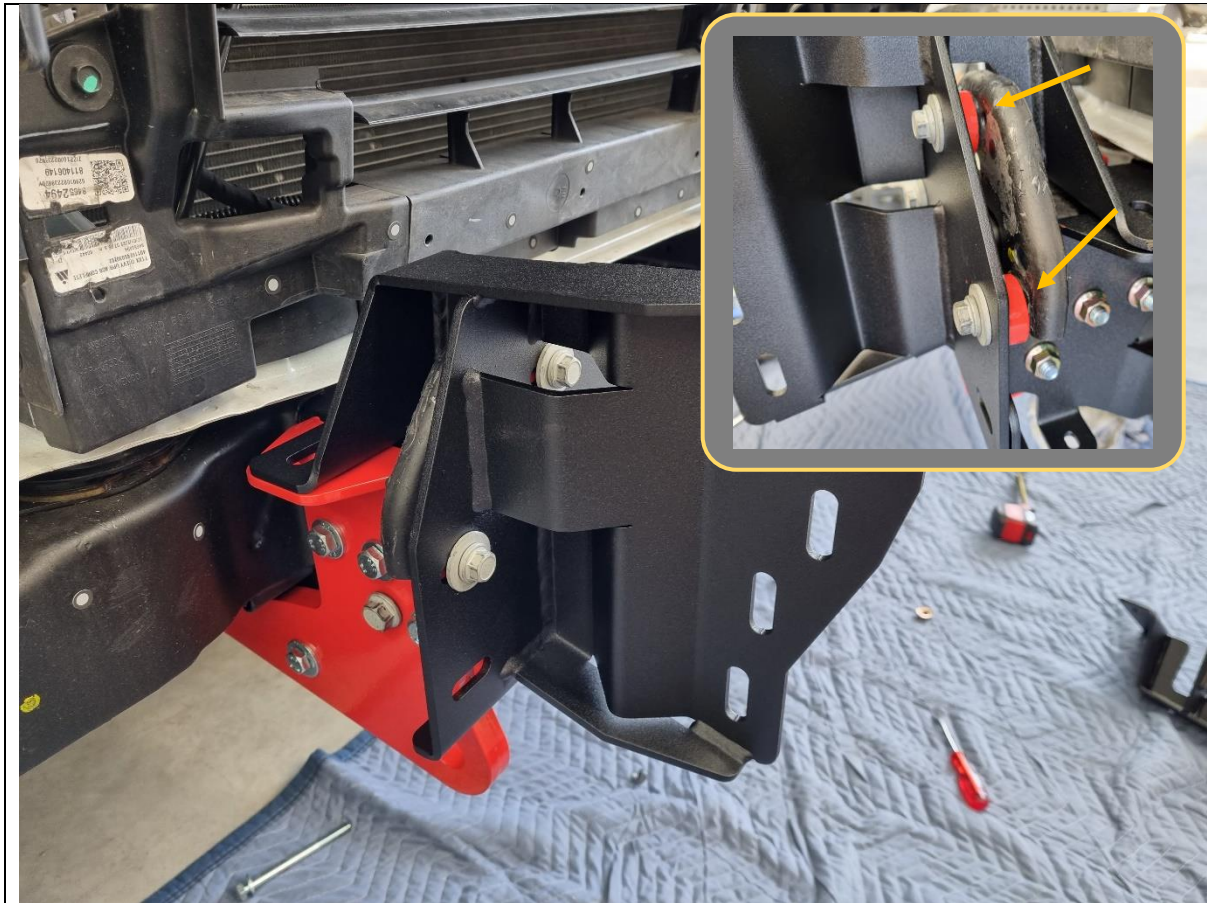

- 38. Slide the RH impact assembly from the side and onto the chassis.
- 39. Loosely secure to the chassis with 3x factory retained M10x35 hex bolts (from Step 21) and round tow point spacer blocks wedged inbetween (see inset).
- 40. Repeat for the LH impact assembly.

TOOLS REQUIRED

15mm socket

FASTENERS

6x factory M10x35 hex bolt

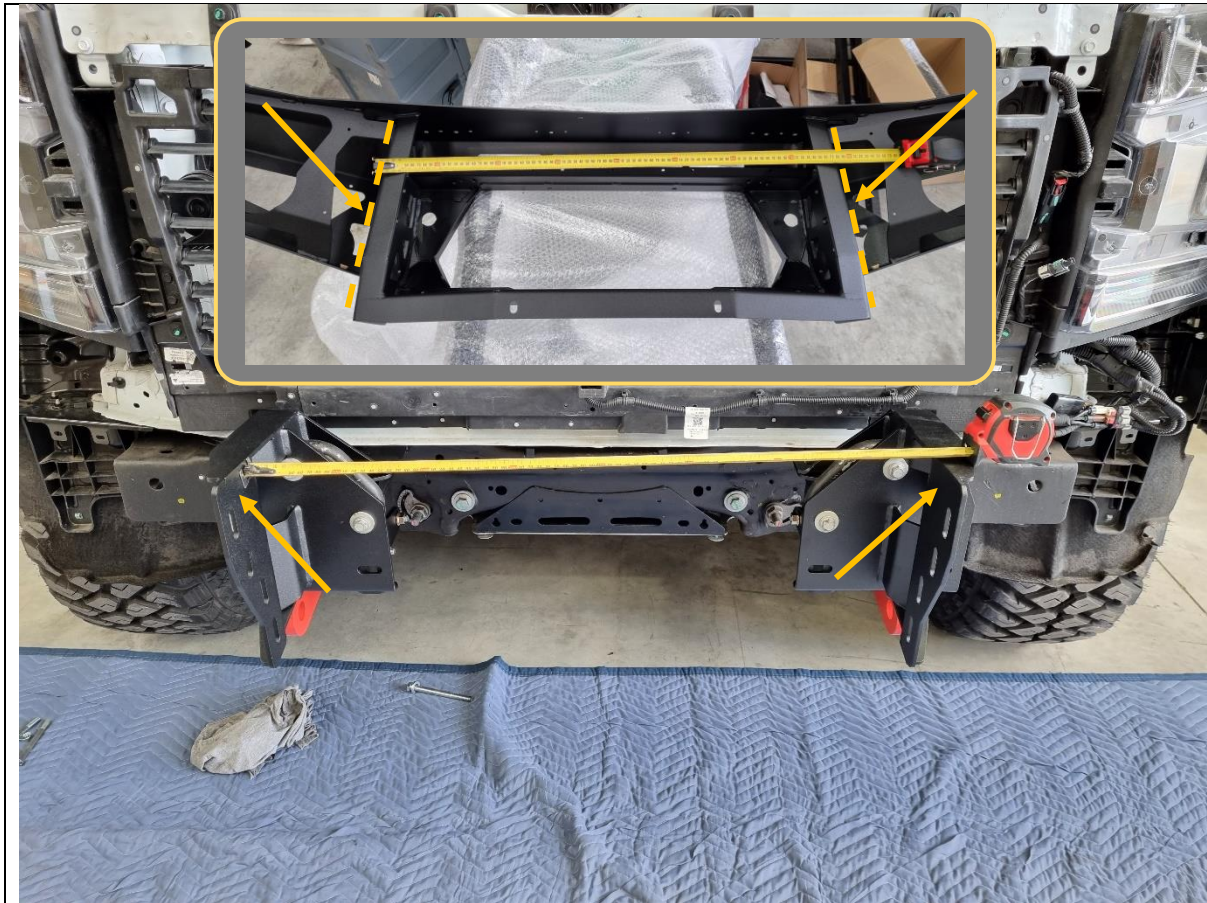

41. Measure the distance between the outside faces of uprights on bar using tape measure. Write distance below for reference if required.

Bar Upright Width = _____mm

42. Adjust mounts by sliding left/right on the slots, such that distance between inner faces of mounts are approximately 2mm more than bar. Ensure the mount faces are vertically upright and symmetric left/right on the chassis.

43. Secure and tighten mounts.

TOOLS REQUIRED

Tape measure

15mm socket

FASTENERS

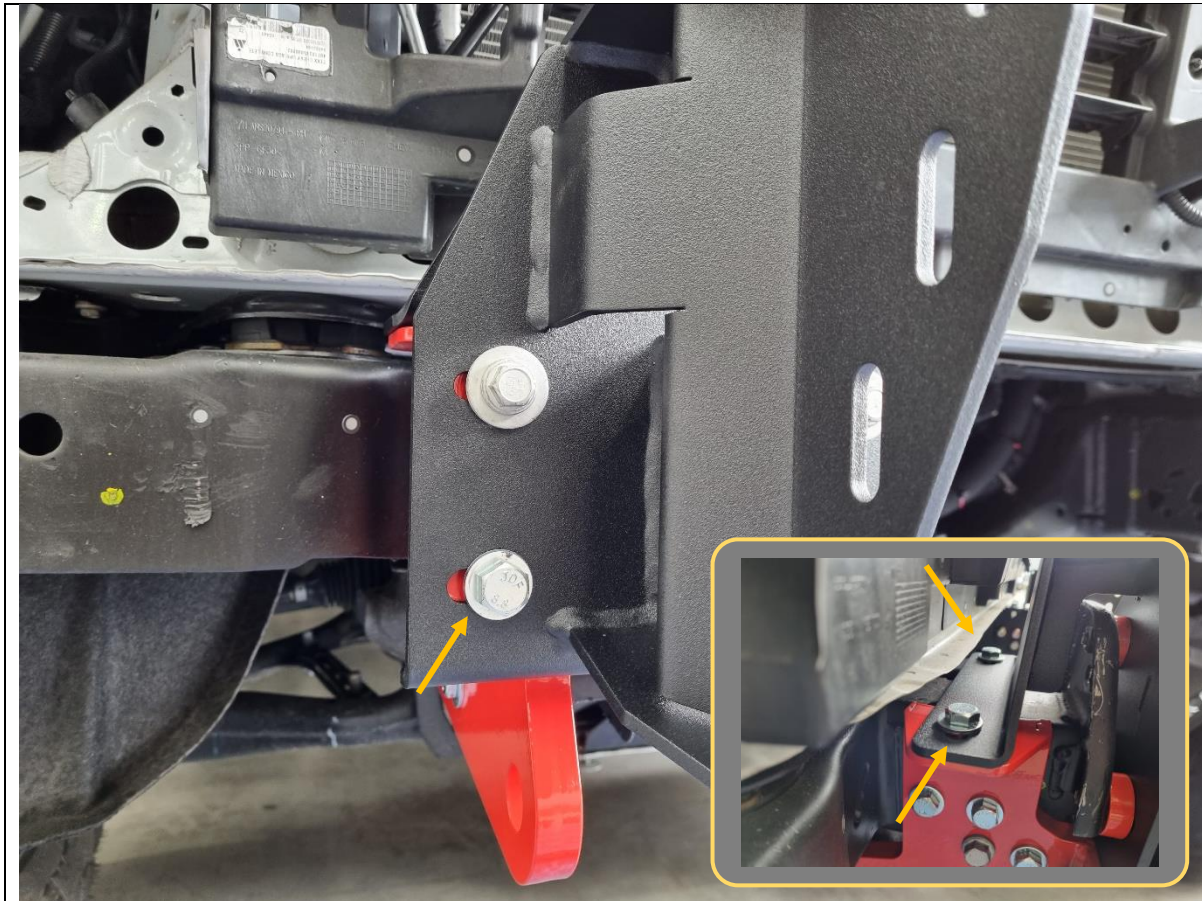

44. Fit remaining 4x M12x30 hex bolts, flat washers and flange nuts for the RH impact assembly.

The 2x bolts on the lower face can be tightened with a socket.

The 2x bolts on the top flange can be tightened with a spanner.

45. Repeat for the LH impact assembly.

TOOLS REQUIRED

18/19mm spanner
18/19mm socket

FASTENERS

8x M12x30 hex bolt
8x M12 flat washer
8x M12 flange nut



46. The bumper winglets will need to be removed and set aside for trimming later.

47. Release the 2x push pins on the lower portion.

Hint: Use an 8mm socket/spanner pressed on the back of the pin to help push it out.

48. Pull the winglet outwards to release the remaining clips. For reference, there are 2x located near the headlight and the remainder along the quarter panel edge.

TOOLS REQUIRED

FASTENERS



49. Using a 10mm socket, remove all the bolts securing the wheel guard bracket to the vehicle. Retain these fasteners for re-use.

TOOLS REQUIRED

10mm socket

FASTENERS

10mm hex bolts

Retain for Reassembly

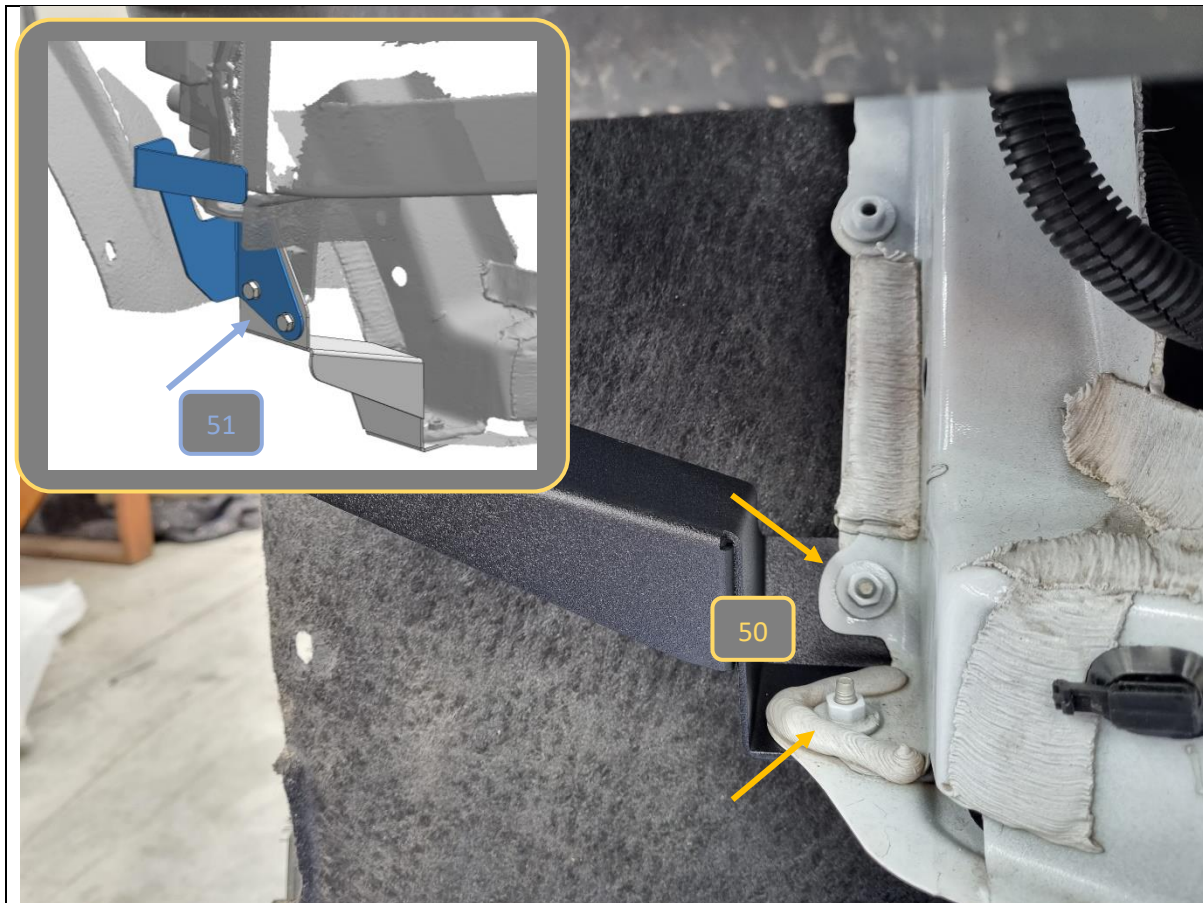

- 50. Fit the supplied headlight bracket to the body with 2x 10mm hex bolts (from Step 49).
 - 51. Fit the supplied bumper winglet support bracket to the headlight bracket and vehicle headlight with 1x 10mm hex bolt (from Step 73) and 2x M6x12 hex bolts, flat washers and flange nuts.
- Use the factory retained bolt for the hole to the vehicle headlight and use supplied bolts in remaining holes.
- 52. Repeat for other side of vehicle.

TOOLS REQUIRED

10mm socket

FASTENERS

6x factory 10mm hex bolts

4x M6x12 hex bolt
4x M6 flat washer
4x M6 flange nut

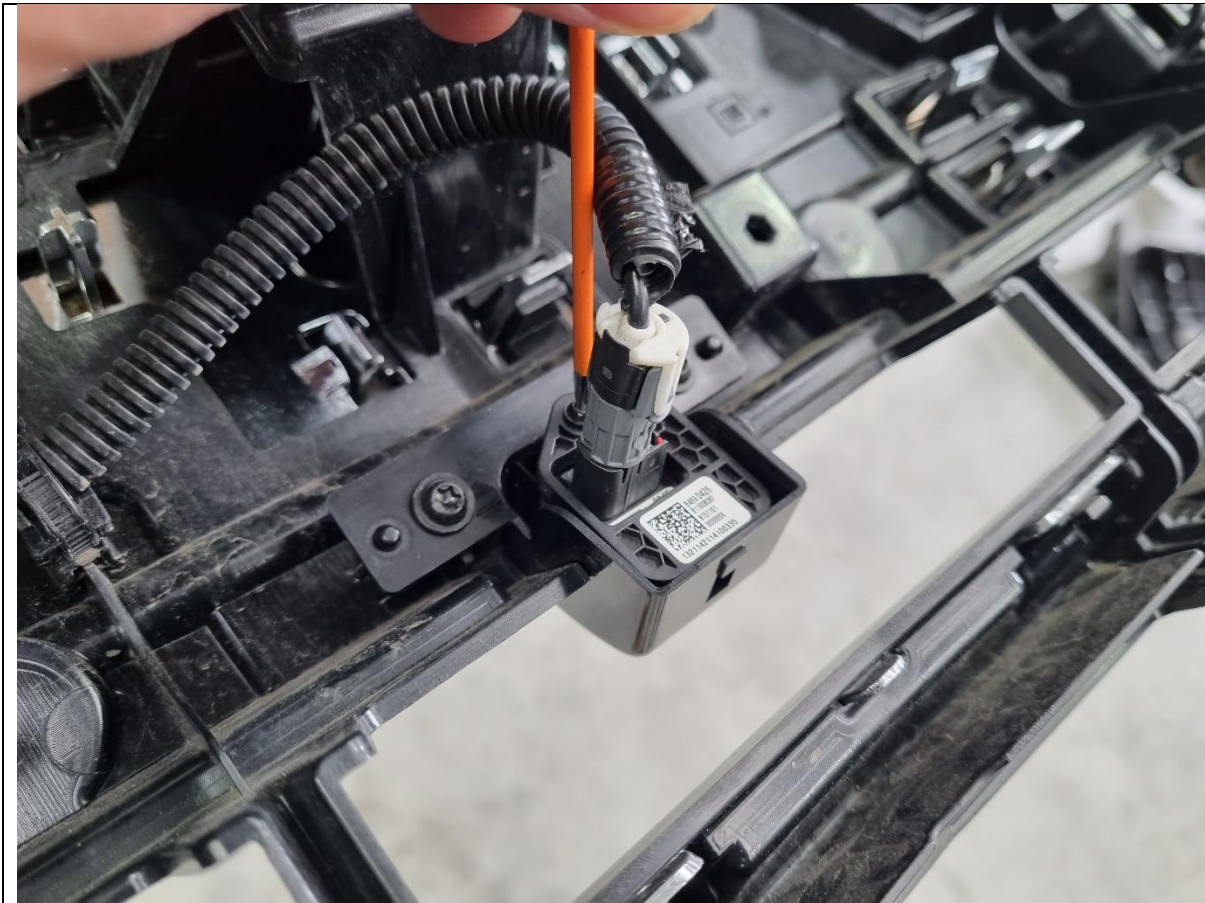

53. If equipped, the front camera can be optionally relocated for a clearer unobstructed view. This is especially recommended if running optional driving lights or top tubes.

Unscrew the T10 Torx screws and remove the camera and loom from the grille. Set aside for relocation later.

54. The plastic camera housing is not required for relocation, and may be refitted back into the grille, with the camera body separated from it.

55. Disconnect the camera harness on the camera body side and reconnect the other end back to the vehicle.

56. Refit the grille, cover and bonnet release handle to the vehicle in reverse order.

TOOLS REQUIRED

T10 Torx Driver

Trim Tool

FASTENERS

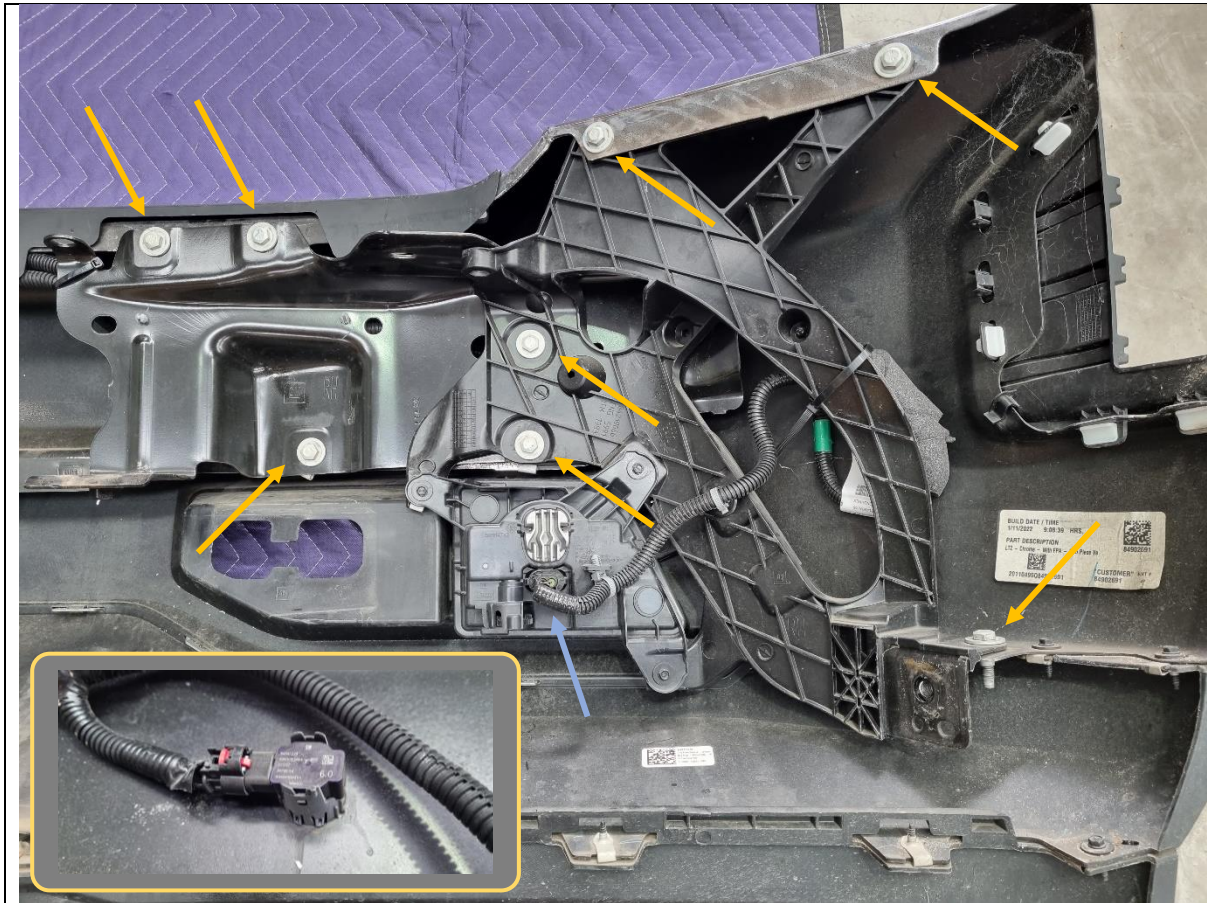

- 57. Prepare the bumper for stripping sensors and looms.
 - 58. Remove the number plate and set aside.
 - 59. Undo the 8x 13mm hex bolts securing the inner bumper reinforcement (per side) to the bumper.
 - 60. Cut any cable ties and pry off any loom clips to free the reinforcement piece and discard.
 - 61. Unplug the fog light connectors (blue arrow).
 - 62. Unclip the 4x parking sensors from their plastic holders. The holders will not be re-used.
- Note down the orientation of the parking sensors before fully removing.

TOOLS REQUIRED

- 13mm socket
- Side cutters
- Trim tool

FASTENERS



- 63. Strip the loom and sensors from the bumper.
- 64. Prepare the bar for fitment. Start by routing the loom and sensors through the bar such that all plugs are in the correct location. Secure loom with cable ties to the bar.
- 65. If the option has been selected, fit the Offroad Animal Halo fog lights to the supplied fog light brackets using 4x M4x12 pan head screws, flat washers and flange nuts (each).

TOOLS REQUIRED

- Phillips head screwdriver
- Cable ties

FASTENERS

- 8x M4x12 pan head
- 8x M4 flat washer
- 8x M4 flange nut

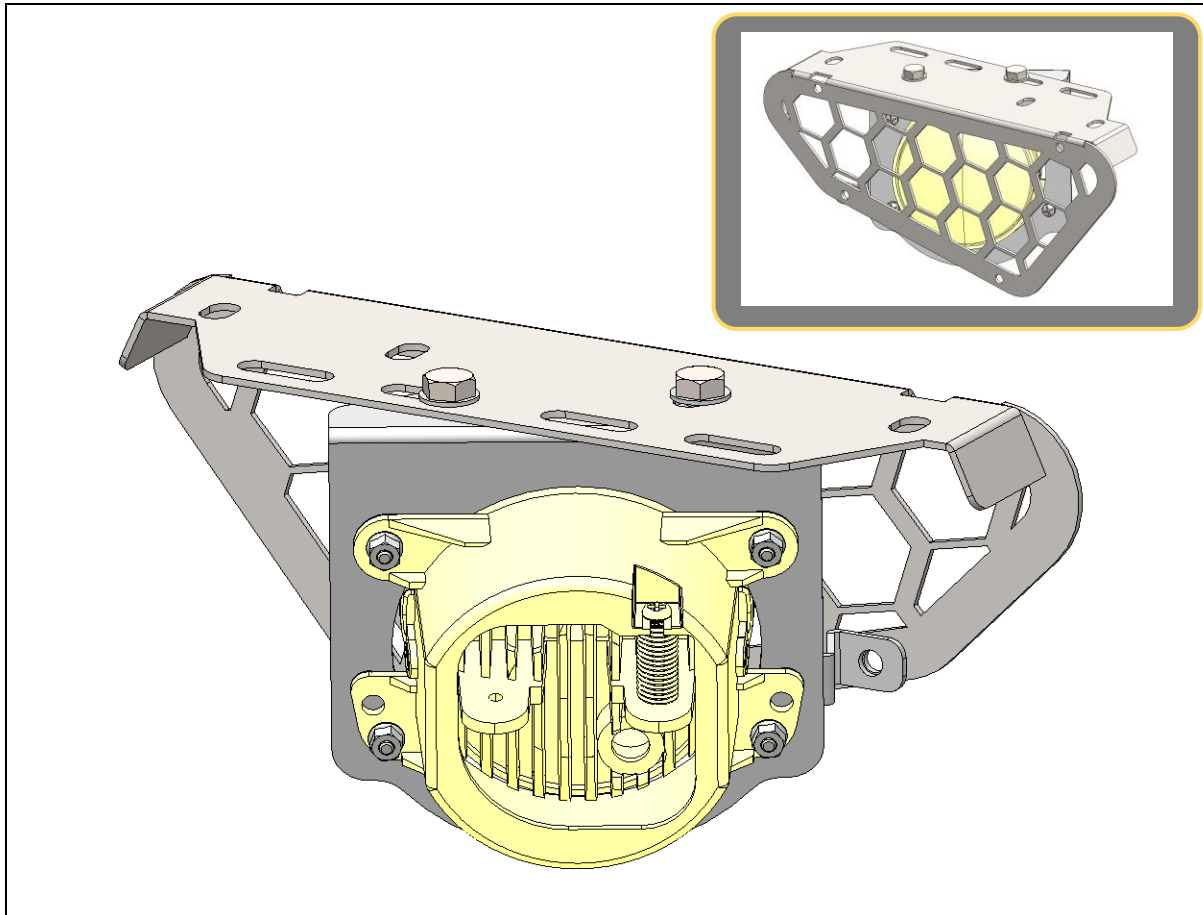

66. Fit the fog light and bracket to the mesh panel, using the supplied 2x M8x12 hex bolts, flat washers and flange nuts.

Match the orientation as shown.

67. Repeat for other fog light.

TOOLS REQUIRED

13mm socket

FASTENERS

4x M8x12 hex bolt
4x M8 flat washer
4x M8 flange nut



- 68. Fit the fog light + mesh panel to the bulbar using 4x M16x16 black button head bolts, black flat washers and flange nuts.
- 69. Secure and tighten using 4mm hex/Allen key and repeat for other side.
- 70. Re-wire the fog light and connect to the bumper loom.

TOOLS REQUIRED

4mm hex/Allen key

FASTENERS

8x M6x16 black button head
8x M6 black washer
8x M6 flange nut

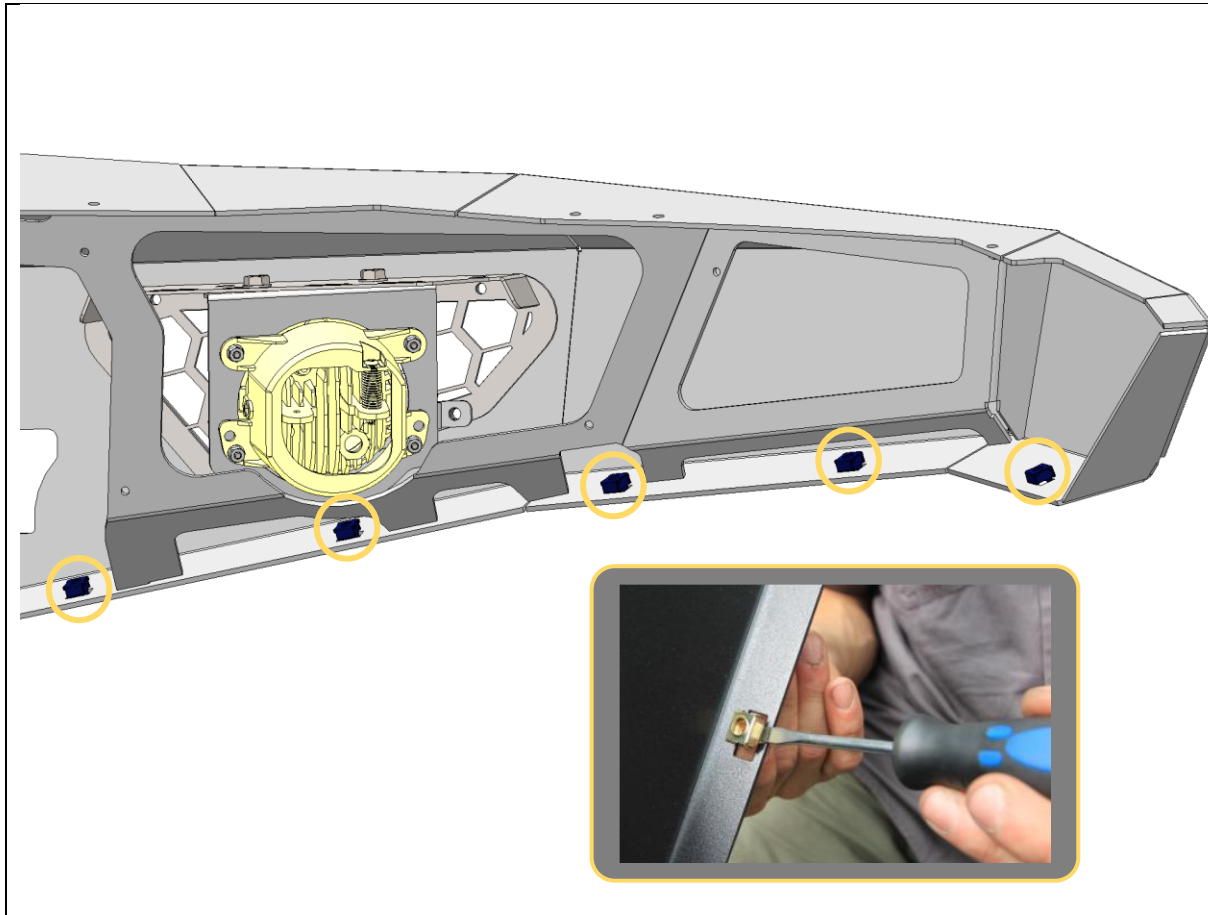

71. Fit 5x M6 cage nuts into the rectangular slots on the bottom of the bar wing.
- To aid fitting, use a small flat blade screwdriver to push the edge of the cage nut to engage with the slot.
72. Repeat for other side of the bar.

TOOLS REQUIRED

Flat blade screwdriver

FASTENERS

10x M6 cage nut

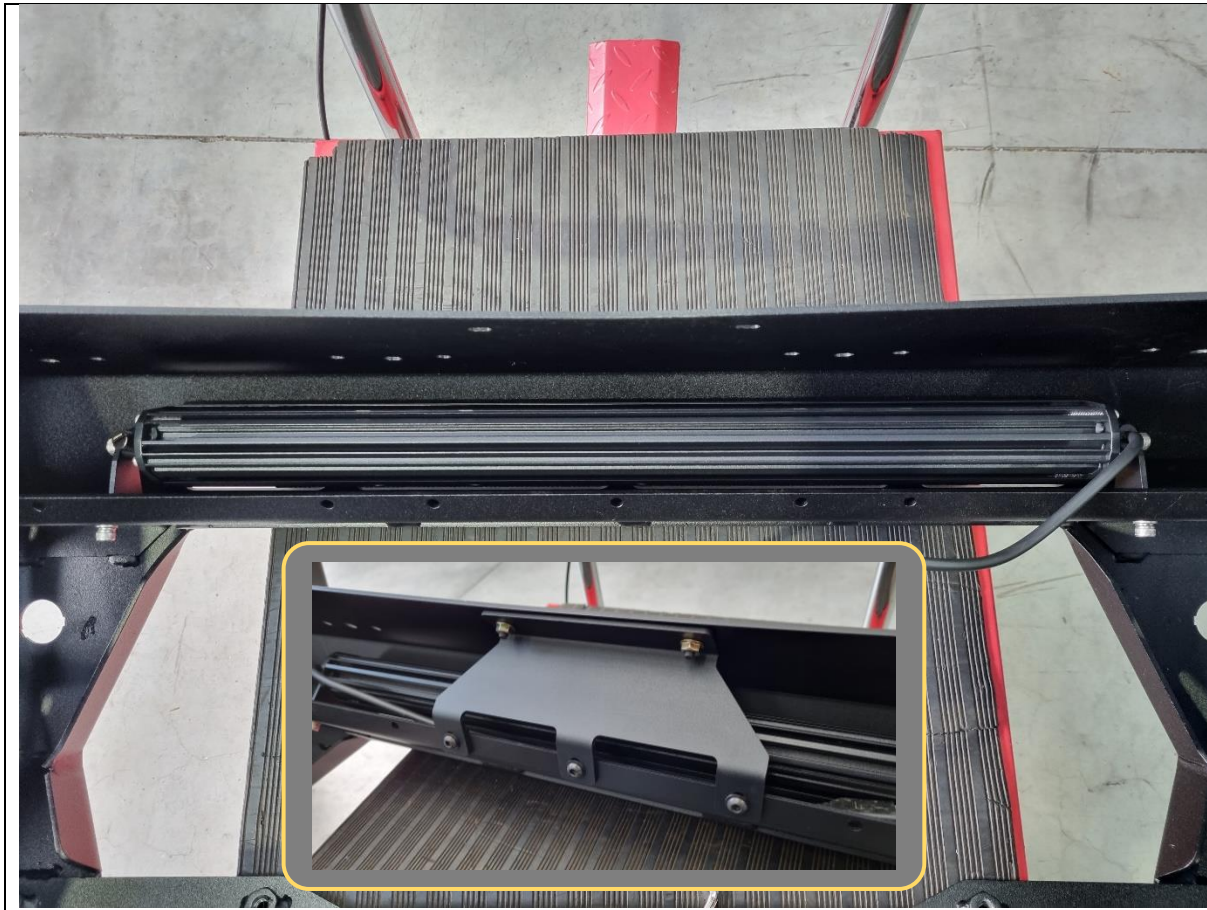

73. If fitting an integrated light bar, do so now.

This bar is designed to fit the Offroad Animal 22-inch light bar. If fitting this light bar, assemble the light bar with legs facing outwards, and line it up with the slots in the centre gusset. Secure with M6 fasteners supplied with the light.

This bar can accommodate most other “20-22inch” size light bars.

74. If fitting driving lights or top hoop to this bar, this is also the most convenient time to do so. It is still possible later but is more difficult.

75. Fit the pan brace to the back of the bar using 5x M6x16 black button head bolts, flat washers and flange nuts.

TOOLS REQUIRED

4mm hex/Allen key
10mm spanner

Supplied with light bar

FASTENERS

5x M6x16 black button head
5x M6 black flat washer
5x M6 flange nut

Supplied with light bar



76. If not fitting parking sensors, insert the 4x supplied round plastic blanking plugs into the holes of the bar.
77. Otherwise, clean area surrounding the parking sensor holes in the bar with isopropyl alcohol or similar cleaning solvent and let it dry.
78. Lightly scuff the bonding surfaces of the 4x supplied plastic sensor housings with sandpaper. Then clean with isopropyl alcohol or similar.
79. Apply the 3M Primer 94 adhesion promotor from the tape kit to the parking sensor locations, on both the bar and the sensor housings.
Important: allow at least 5 minutes for the primer to chemically bond to the surfaces before applying tape.
80. Apply supplied VHB tape pads to all sensor housings as shown in the inset photo.
81. Dry fit sensors to bar to check loom position is correct.
82. Remove backing and adhere sensors in position in bar. Apply pressure for 20-30sec after positioning for best adhesion.
83. Add a pea-sized blob of automotive adhesive sealant over the sensor holder and inside face of bar to hold to ensure the tape holds position.
84. Connect all parking sensor loom connectors.

TOOLS REQUIRED

Isopropyl alcohol
Rag
Sandpaper
Automotive adhesive sealant
(eg. Sikaflex)

FASTENERS

VHB Tape pads
Primer 94



- 85. With assistance, either from another person, or a lifting trolley, lift the bar onto the mounts on the vehicle.
- 86. Reconnect the fog light and sensor loom to the vehicle.
- 87. Secure with 8x M12x30 Bolts, heavy duty washers and M12 Nyloc + flange nuts. Leave finger tight at this stage.

TOOLS REQUIRED

Lifting trolley

FASTENERS

8x M12x30 hex bolt
8x M12 heavy duty washer
2x M12 Nyloc nut
6x M12 flange nut

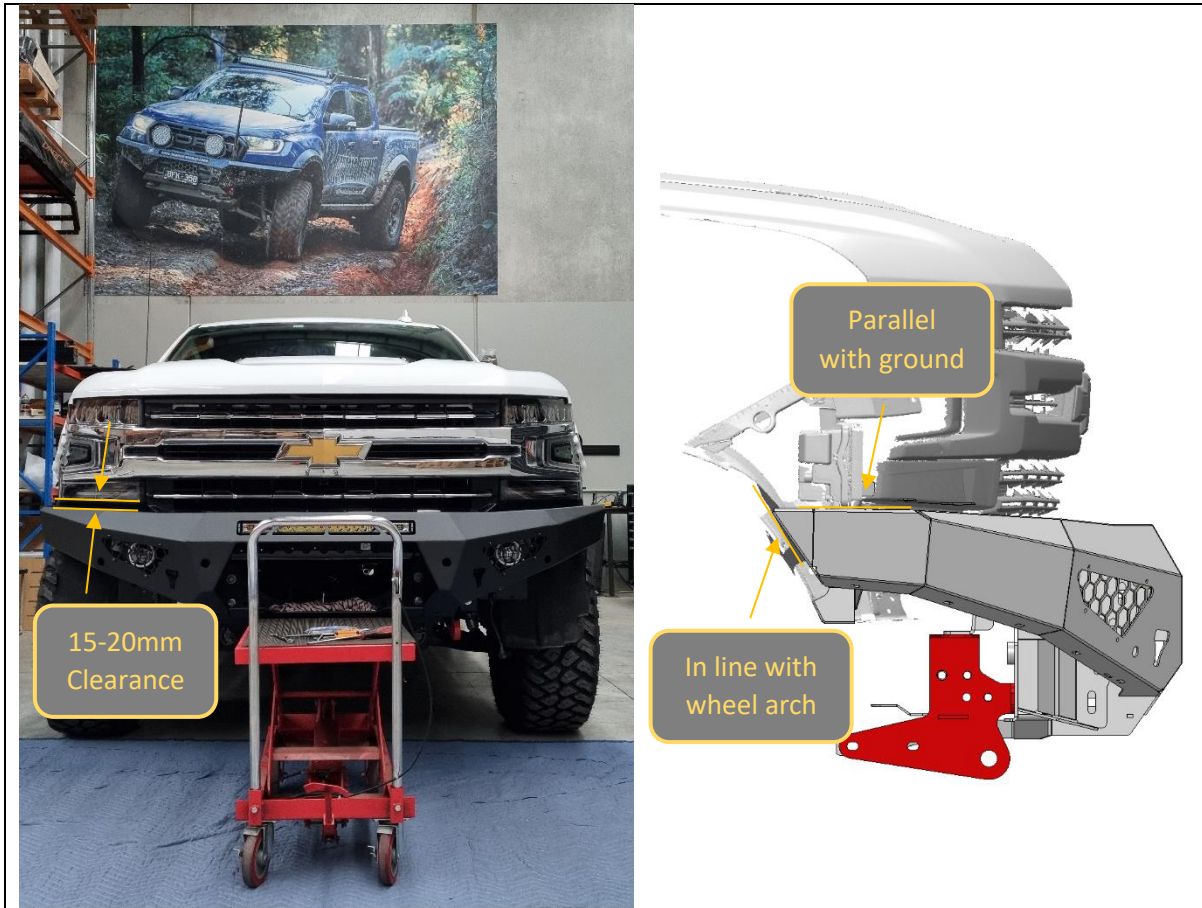

88. With assistance, from another person, align the bar with the edges of the vehicle. The bar should sit symmetric left/right on the vehicle.

In front view, the top face of the bar should sit parallel with the bottom edge of the headlights/headlight infill, with about 15-20mm vertical clearance.

In side view, the end of the bar wing should be in line with the wheel arch liner, and the top face of the wing tip should be parallel to the ground.

Still leave M12 bolts finger tight at this stage.

TOOLS REQUIRED

Lifting trolley

FASTENERS



89. The bumper winglet will now need to be trimmed to fit with the bar. Begin with a conservative cut and then make final precision cuts once test fitted on the vehicle.
90. Using the back corner of the panel as reference, measure and mark out a horizontal cut line as shown.

It is recommended to use masking tape to protect the outside from being scratched.
91. Perform a straight through cut using an air hacksaw / multi tool / angle grinder / jigsaw.

TOOLS REQUIRED

- Air Hacksaw
or
Oscillating Multi Tool
or
Angle Grinder
or
Jigsaw
- Tape Measure
- Masking Tape

FASTENERS

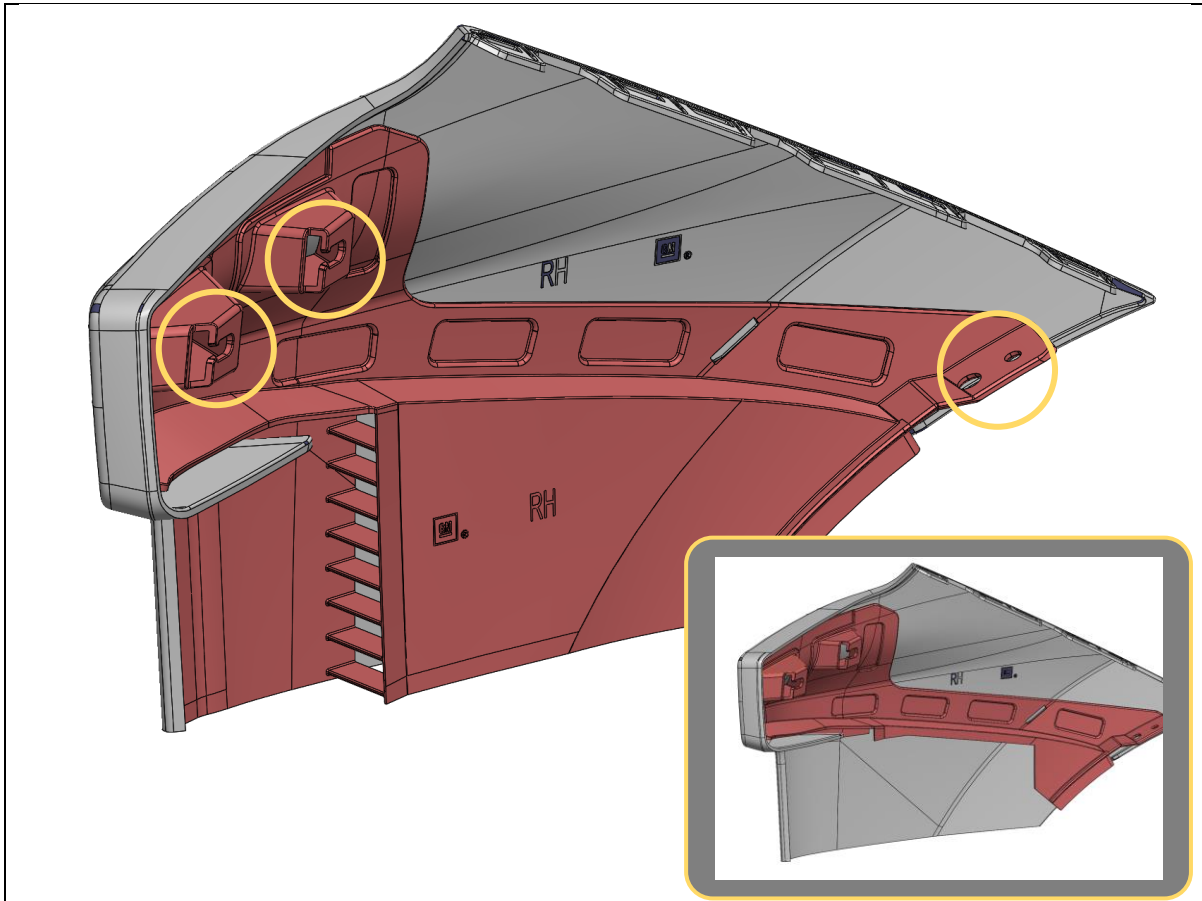

92. The inner skin of the bumper winglet will also need to be partially trimmed and removed. The circled areas must be retained for the bumper winglet to clip back onto the vehicle.
93. Using a utility knife or other cutting implement, carefully cut away at the inner skin (red shaded section) in the lower half of the trimmed panel, as shown in the inset.
- The inner skin is heat staked onto the outer skin, so can also be peeled away to separate.

TOOLS REQUIRED

Utility knife
or
Air Hacksaw
or
Oscillating Multi Tool
or
Angle Grinder
or
Jigsaw

FASTENERS

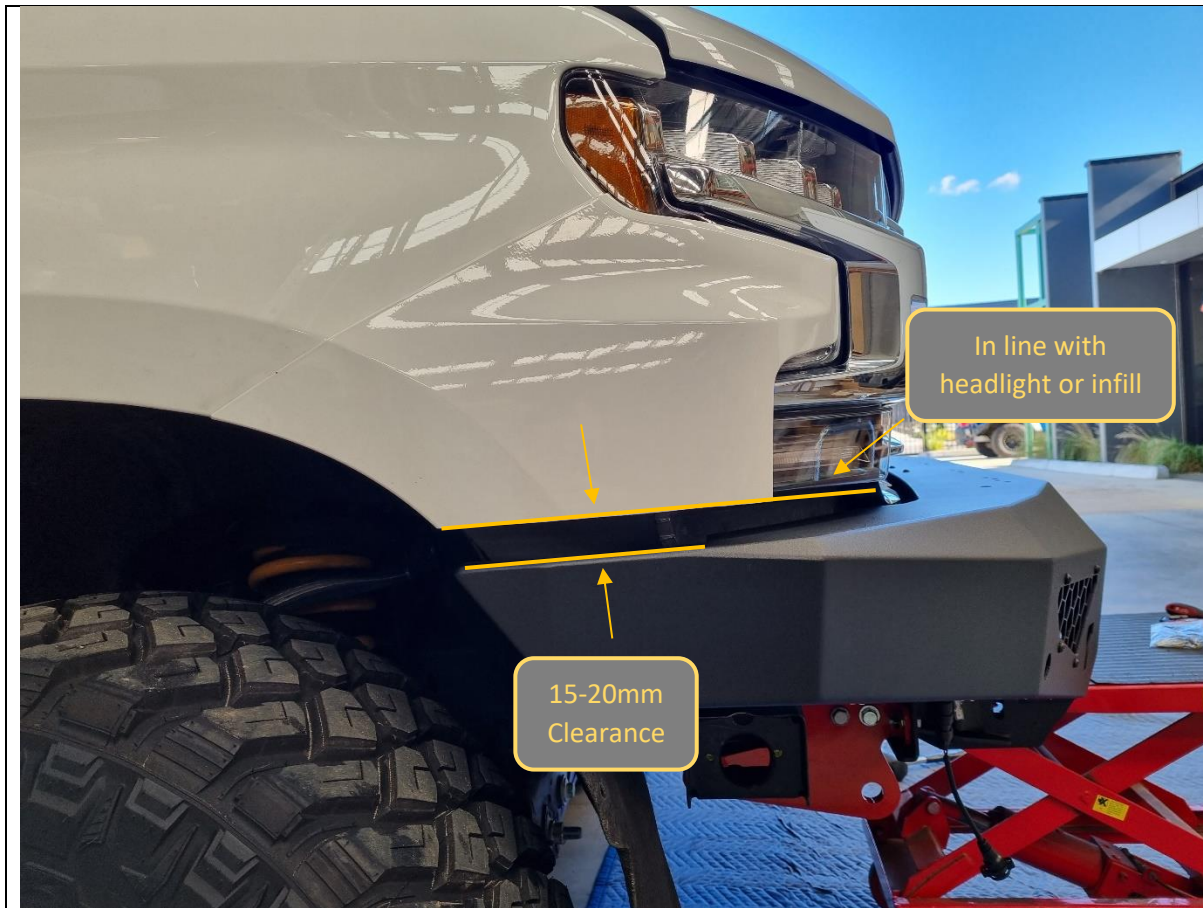

<p>94. Test fit the trimmed panel by loosely holding it in position on the vehicle.</p> <p>95. Make further trims and adjustments until the bottom edge of the bumper winglet is in line with the bottom of the headlight/infill and has 15-20mm vertical clearance to the bar.</p>	<p>TOOLS REQUIRED</p>
	<p>FASTENERS</p>



<p>96. Clean the outer face of the winglet support bracket and the inside of the trimmed bumper winglet with isopropyl alcohol or similar cleaning solvent and let it dry.</p> <p>97. Apply the 3M Primer 94 adhesion promotor onto both cleaned surfaces.</p>	<p>TOOLS REQUIRED</p> <p>Isopropyl alcohol Rag</p> <p>18/19mm socket</p>
<p>98. Apply 2x 100mm strips of VHB tape onto the winglet support bracket in the arrangement shown in the inset.</p> <p>Important: allow at least 5 minutes for the primer to chemically bond to the surfaces before applying tape.</p> <p>99. Remove backing film of VHB tape and install the trimmed bumper winglet back onto the vehicle. Apply pressure for 20-30sec after positioning for best adhesion.</p> <p>100. Make final position adjustments to the bar, then tighten all 8x M12 bolts.</p>	<p>FASTENERS</p> <p>VHB Tape pads Primer 94</p>



<p>101. If fitting a winch, do so now.</p> <p>This bar is designed to fit most low mount winches, in foot down configuration. WARN ZEON 12 is the largest winch confirmed to fit.</p>	<p>TOOLS REQUIRED</p> <p>Refer to instructions supplied by winch</p>
<p>102. The control box can be mounted on top of the winch, or to the side as shown. Winches usually come with a bracket to allow this. Refer to winch manufacturer.</p> <p>In some rare cases, the winch control box may need to be relocated elsewhere using custom bracketry.</p> <p>103. Ensure clutch handle will be accessible through opening in front mesh panel. Refer to winch instructions regarding changing clutch handle location.</p>	<p>FASTENERS</p> <p>Supplied with winch</p>



- 104. Loosen the M12 flange nut on the rearmost chassis mount hole installed in Step 33.
- 105. Install the tension strap connecting the winch cradle to the rearmost chassis mount hole, using 1x M10x25 hex bolt, flat washer and flange nut. Re-secure the rear with the M12 flange nut.
- 106. Repeat on other side for other tension strap.

TOOLS REQUIRED

- 16mm socket
- 18/19mm socket

FASTENERS

- 2x M10x25 hex bolt
- 2x M10 flat washer
- 2x M10 flange nut



<p>107. If required, fit the winch fairlead to the mesh fairlead mount using M10 or 3/8" fasteners supplied with the winch. This bar is only compatible with hawse type fairleads.</p> <p>108. Fit number plate flip mount to mesh panel using 2x M6x20 hex bolts, flat washers and flange nuts supplied in the number plate flip kit.</p>	<p>TOOLS REQUIRED</p> <p>10mm socket 13mm socket/spanner 4mm hex/Allen key Phillips head screwdriver</p>
<p>109. Attach number plate to mount using supplied pan head screws in the number plate flip kit.</p>	<p>FASTENERS</p> <p>2x M6x20 hex bolt 2x M6 flat washer 2x M6 flange nut</p>

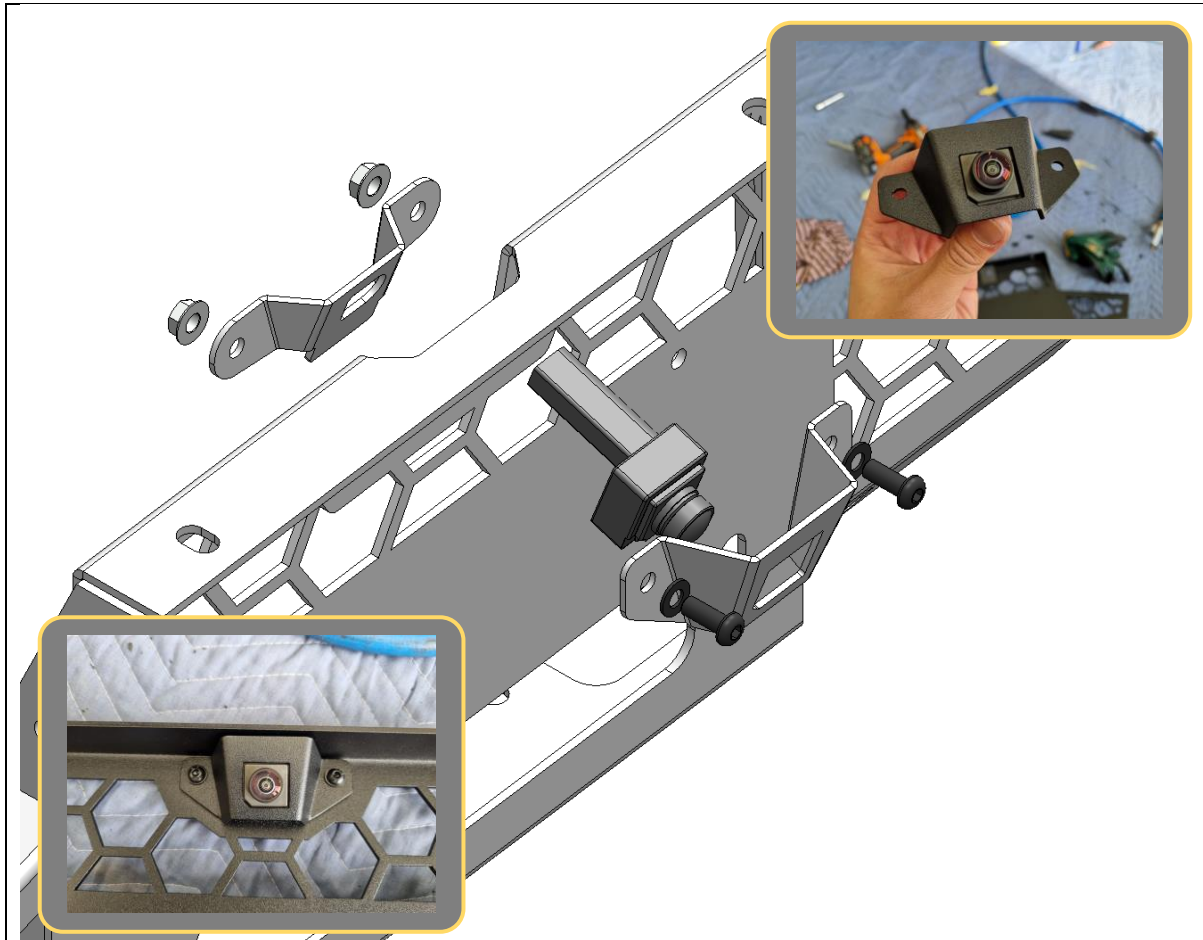

110. If relocating the front camera, sandwich the camera between the camera mount and backing plate, then attach to the mesh fairlead mount using 2x M16x16 black button head bolts, black flat washers and flange nuts.

TOOLS REQUIRED

4mm hex/Allen key

FASTENERS

2x M6x16 black button head
2x M6 black flat washer
2x M6 flange nut



- 111. Fit the mesh fairlead mount to the centre of the bar, using 2x M8x16 black button head bolts (top), 2x M8x20 hex head bolts (bottom) and 4x flat washers.
- 112. Tighten fasteners using 13mm socket/spanner and 5mm hex/Allen key.
- 113. Feed winch cable through the hawse fairlead if applicable.
- 114. Reconnect the camera harness (if equipped) to the back of the mesh fairlead mount.

TOOLS REQUIRED

13mm socket/spanner
5mm hex/Allen key

FASTENERS

2x M8x16 black button head
2x M8 black flat washer

2x M8x20 hex head
2x M8 flat washer



- 115. Fit the centre bash plate to the bar using 4x M8x20 black button bolts and flat washers.
- 116. Secure the back of the centre bash plate to the chassis mount bracket using 2x M10x25 hex bolts, flat washers and flange nuts (see inset).

TOOLS REQUIRED

- 5mm hex/Allen key
- 16mm socket/spanner

FASTENERS

- 4x M8x20 black button head
- 4x M8 black flat washer
- 2x M10x25 hex bolt
- 2x M10 flat washer
- 2x M10 flange nut

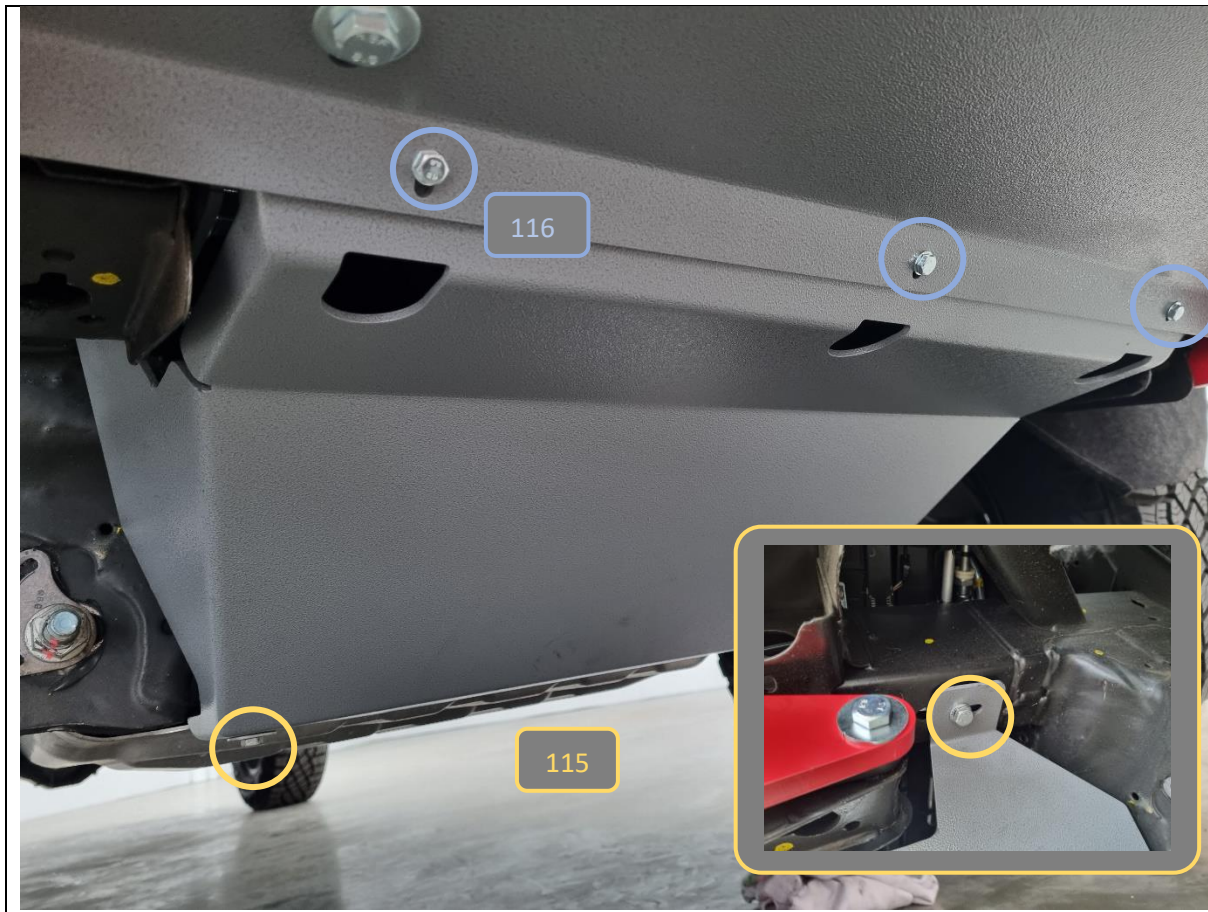

117. Fit the lower bash plate to the vehicle by re-using the 4x 13mm hex bolts from Step 25.

118. Secure the front lip of the lower bash plate to the centre bash plate with 3x M6x20 hex bolts, flat washers and flange nuts.

Note: Prototype bash plate shown in image above. Production version has access holes for fitting M6 flange nuts on the inside.

TOOLS REQUIRED

10mm socket
13mm socket

FASTENERS

4x factory 13mm hex bolt

3x M6x20 hex bolt
3x M6 flat washer
3x M6 flange nut

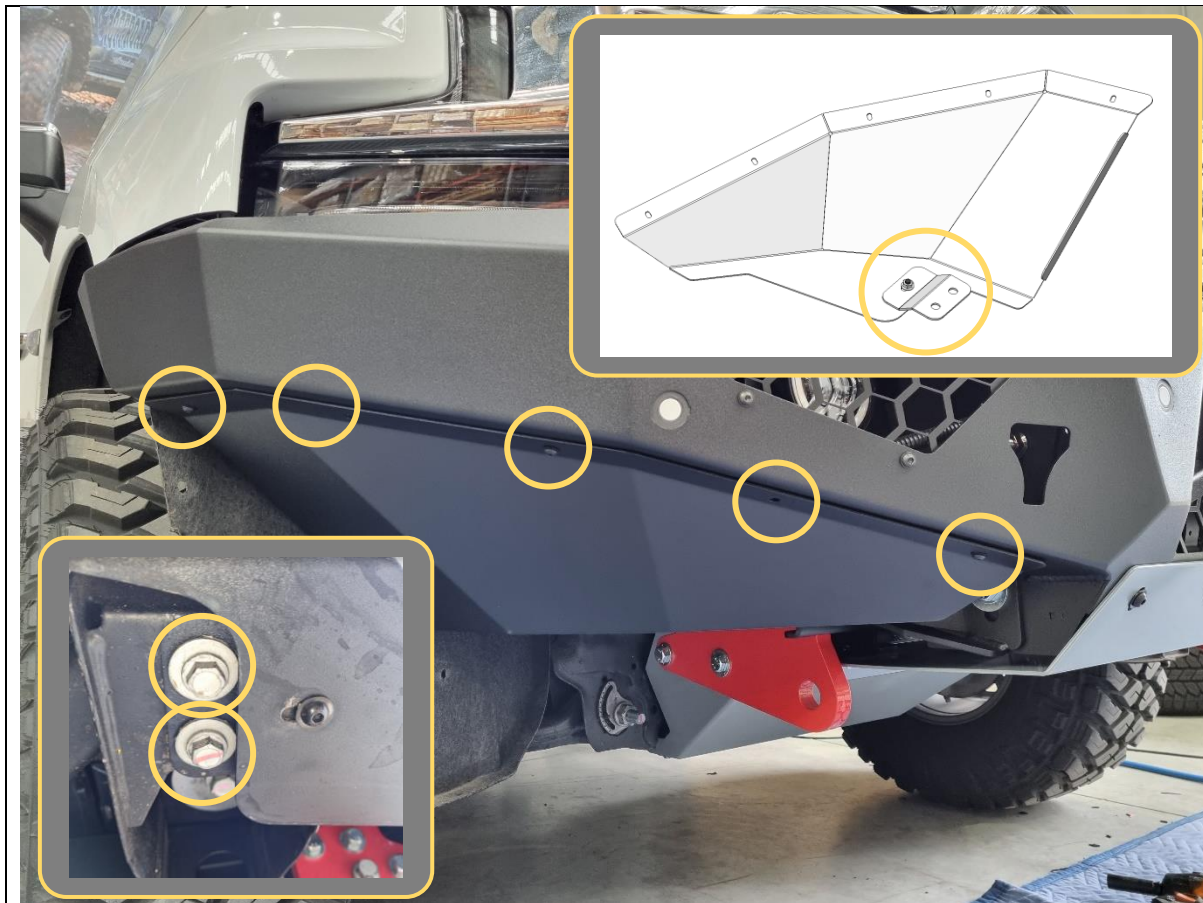

- 119. Loosely fit the side underpanel mount bracket to the side underpanel with 1x M8x16 black button head bolt, black flat washer and flange nut. Leave finger tight at this stage.
- 120. Loosely fit the side underpanel to the bar with 5x M6x16 black button head bolts and black flat washers.
- 121. Loosely fit the side underpanel mount bracket to the chassis with 2x factory 15mm hex bolts retained from Step 12.
- 122. Repeat for other side underpanel.

TOOLS REQUIRED

- 4mm hex/Allen key
- 5mm hex/Allen key
- 15mm socket

FASTENERS

- 4x factory 15mm hex bolt
- 10x M6x16 black button head
- 10x M6 black flat washer
- 2x M8x16 black button head
- 2x M8 black flat washer
- 2x M8 flange nut



<p>123. Using the edge of the side underpanel as a guide, mark the wheel arch liner, approximately 10mm below the side underpanel.</p> <p>124. Cut along the marked line with a utility knife.</p> <p>125. Tuck the wheel arch liner behind the flange of the side underpanel.</p>	<p>TOOLS REQUIRED</p> <p>Utility knife</p> <p>4mm hex/Allen key 5mm hex/Allen key 15mm socket</p>
<p>126. Tighten all side underpanel bolts and repeat for other side.</p>	<p>FASTENERS</p>



127. Fit the Offroad Animal logo plate to the front of the vehicle as shown.
128. Fit the compliance plate in a visible location on the underside of the bar. We recommend placing it on the bottom of the centre bash plate.
129. **Toro only.** If required, fit the supplied antenna mounting brackets to the back of the bar, and secure with 2x M8x20 black button head bolts and black washers, each.
130. **Toro only.** Else fit the 2x M8x20 black button head bolts and black washers to the back of each bullbar upright, to protect nut threads in bar for future use.
131. Review fitment and double check all bolts are tightened correctly.

TOOLS REQUIRED

5mm hex/Allen key

FASTENERSM8x20 black button head
M8 flat washer



Congratulations! You're done!
Head for the tracks and enjoy your newly protected Chevrolet Silverado 1500!