



CHEVROLET SILVERADO 1500 ZR2

4th Gen 2023+ Predator & Toro Front Bar

Fitting Instruction







IMPORTANT! – READ BEFORE INSTALLATION

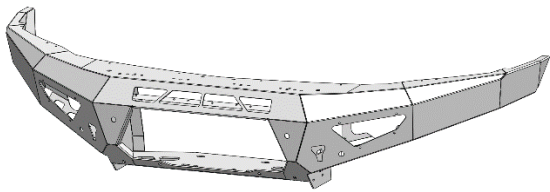
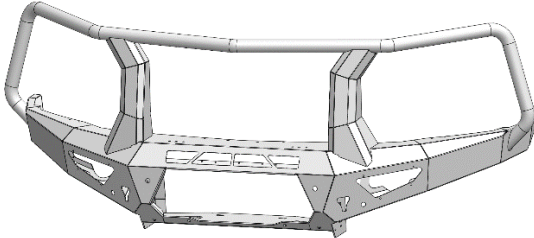

- When installed in accordance with these instructions, the front protection bar does not affect the operation of the vehicles SRS airbags.
- This product must be installed exactly as per these instructions using only hardware supplied.
- Take a few moments to read instructions thoroughly before beginning work.
- In the event of damage to any bar component please contact OFFROAD ANIMAL to arrange repair/replacement of components.
- Do not use this product for any vehicle make or model other than that specified on these instructions.
- Do not remove labels from this product.
- This product and its fixings must not be modified in any way unless stated in these fitting instructions.
- The installation of this product is recommended for trained personnel.
- These instructions are correct at time of publication. OFFROAD ANIMAL cannot be held responsible for the impact of any changes subsequently made by the vehicle manufacturer. If you find something has changed, please contact us to let us know!
- During installation it is the duty of the installer to check correct operation/clearances of all components.
- If Instructions are to be printed for reference in the workshop, it is recommended that they are printed in colour, for best legibility.

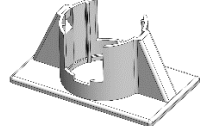
PARTS LISTING

IMPORTANT: Check all parts are present before beginning work! Contact OFFROAD ANIMAL if something is missing.

Parts – In the Main Box

Qty	Part Number	Description	Image
1	FB-S15-T1-23-PR-ASM1	Silverado 1500 Predator Bar Welded Assembly	
OR			
1	FB-S15-T1-23-TOR-ASM1	Silverado 1500 Toro Bar Welded Assembly	
4	CPHP029	Plastic Hole Insert, 17.4MM, Black, Tigerlink Hardware CPHP029	
4	F-0015	Chevrolet/Jeep Sensor Holder – Straight	
1	FB-S15-T1-20-PR-ADRCP	ADR Compliance Plate Silverado 1500	
1	OFA-LOGO	Offroad Animal Metal Logo	
2	PWS-TOP-600	Pinch Weld PWS51T – Top Bulb Seal 600mm	

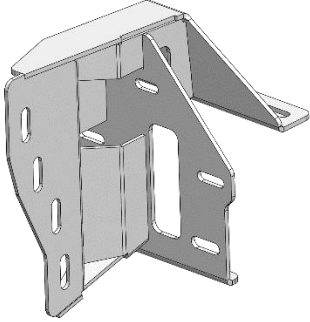
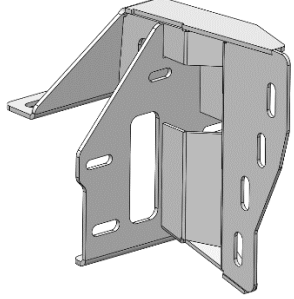
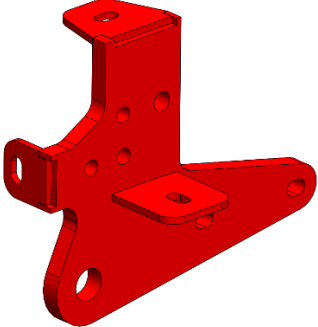

1	TK-COM-PSEN-4	Tape Kit – 4 Sensor Universal	
6	TK-FB-FRA-NG-22	Tape Kit – Next Gen Ranger Front Bar	

Parts – In the Fitting Kit Box

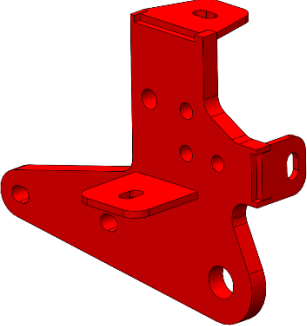
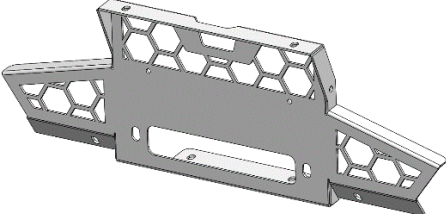
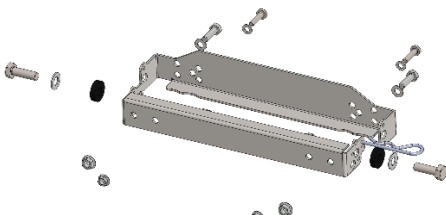
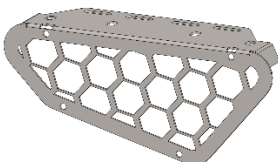
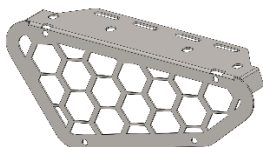
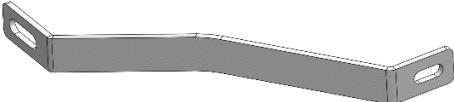
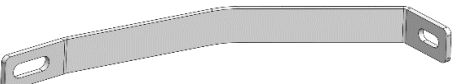
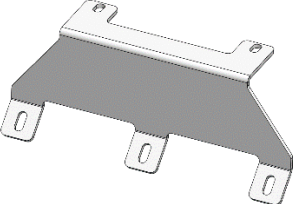
Qty	Part Number	Description	Image
1	FB-S15-T1-20-PR-ASM2R	Silverado 1500 Impact Assembly	
1	FB-S15-T1-20-PR-ASM2L	Silverado 1500 Impact Assembly	
1	FB-S15-T1-20-PR-ASM3R	Silverado 1500 Tow Point Assy	

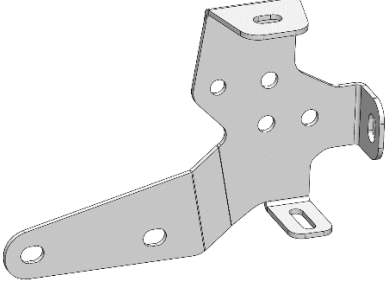
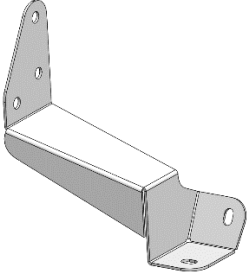
<p>1</p>	<p>FB-S15-T1-20-PR-ASM3L</p>	<p>Silverado 1500 Tow Point Assy</p>	
<p>1</p>	<p>FB-S15-T1-20-PR-ASM4</p>	<p>Silverado 1500 Mesh Fairlead Assy</p>	
<p>1</p>	<p>NPF-COM-SM-ASM0</p>	<p>Number Plate Flip ASM Small</p>	
<p>1</p>	<p>M-0002R</p>	<p>Light Cover Mesh</p>	
<p>1</p>	<p>M-0002L</p>	<p>Light Cover Mesh</p>	
<p>1</p>	<p>B-0857R</p>	<p>Silverado 1500 Winch Strap</p>	
<p>1</p>	<p>B-0857L</p>	<p>Silverado 1500 Winch Strap</p>	
<p>1</p>	<p>B-0858</p>	<p>Silverado 1500 Pan Brace</p>	

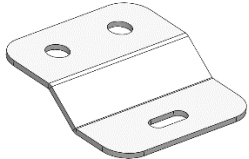
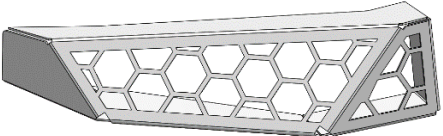
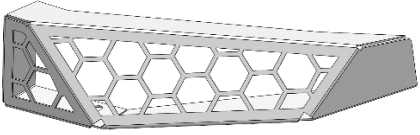
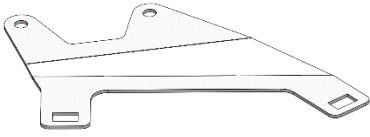
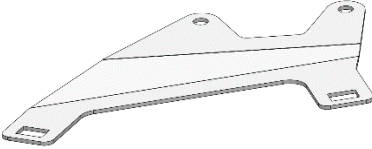
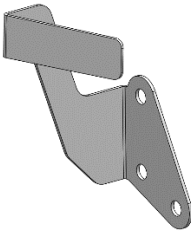
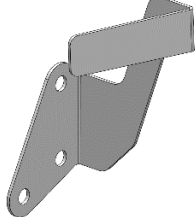
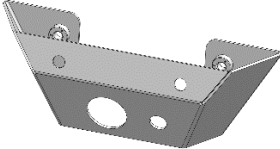
<p>1</p>	<p>B-0861R</p>	<p>Silverado 1500 Halo Fog Light Bracket</p>	
<p>1</p>	<p>B-0861L</p>	<p>Silverado 1500 Halo Fog Light Bracket</p>	
<p>1</p>	<p>B-0862R</p>	<p>Silverado 1500 Front Mount Chassis Brace</p>	
<p>1</p>	<p>B-0862L</p>	<p>Silverado 1500 Front Mount Chassis Brace</p>	
<p>1</p>	<p>B-0866R</p>	<p>Silverado 1500 Headlight Bracket</p>	
<p>1</p>	<p>B-0866L</p>	<p>Silverado 1500 Headlight Bracket</p>	

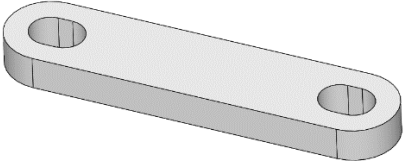
2	B-0867	Silverado 1500 Side Underpanel Mount Bracket	
1	B-0940R	Facelift Headlight Infill	
1	B-0940L	Facelift Headlight Infill	
1	B-0941R	Facelift Headlight Infill Support Bracket	
1	B-0941L	Facelift Headlight Infill Support Bracket	
1	B-0942R	Bumper Winglet Support	
1	B-0942L	Bumper Winglet Support	
1	B-0943	Facelift Camera Housing	
6	P-0024	Ranger Tow Point Spacer	
2	P-0278	Silverado 1500 Tow Point Rear Spacer Plate	

1	U-0064R	Silverado 1500 Side Underpanel	
1	U-0064L	Silverado 1500 Side Underpanel	
1	U-0065	Silverado 1500 Bash Plate	
1	U-0066	Silverado 1500 Lower Base Plate	
TORO BAR ONLY			
2	B-0649	Toro Antenna Bracket – 90 Degree Tall	

PREDATOR Fasteners – Contained in Small Parts Kit Bag

Qty	Part Number	Description
8	M4x12 PAN	SCREW, PAN HEAD PHILLIPS, M4X12X0.7 GR4.6 ZP
8	M4 FLAT WASHER	Flat Washer M4, 8mmODx0.8mm T
8	M4 FLANGE NUT	Flange Nut, M4
4	M5X15 BHCS BZP	SCREW, BUTTON HEAD CAP, M5X15X0.8 GR12.9 ISO4042 ZnNi BLACK PASSIVATED FINISH
4	M5 Flat washer	M5 FW
4	M5 Flat washer BZP	M5 Flat Washer, 10x5.3x1, ISO4042 ZnNi BLACK PASSIVATED FINISH
2	M5 FLANGE NUT	Flange Nut, M5x0.8 G8.8 ZP
4	M6 X 12 HEX	M6X12 HEX BOLT, ZP, 8.8
3	M6 X 20 HEX	M6X20 HEX BOLT, ZP, 8.8
27	M6x16 BHCS BLACK ZINC	SCREW, BUTTON HEAD CAP, M6X16X1 GR12.9, ISO4042 ZnNi BLACK PASSIVATED FINISH
7	M6 FLAT WASHER	M6 FW
27	M6 FLAT WASHER BLACK ZINC	M6 Flat Washer, 12x6.1x1, ISO4042 ZnNi BLACK PASSIVATED FINISH
20	M6 FLANGE NUT	Flange Nut, M6x1 G8.8 ZP
14	M6CN3MM	CAGE NUT M6x2.6-3.5
4	M8 X 12 HEX	Bolt Hex, M8X12x1.25, GR8.8 ZP
4	M8 X 20 HEX	Bolt Hex, M8X20x1.25, GR8.8 ZP
4	M8 X 16 BHCS BZP	SCREW, BUTTON HEAD CAP, M8X16X1.25 GR12.9, ISO4042 ZnNi BLACK PASSIVATED FINISH
4	M8 X 20 BHCS BLACK ZINC	SCREW, BUTTON HEAD CAP, M8X20X1.25, ISO4042 ZnNi BLACK PASSIVATED FINISH
6	M8 FLAT WASHER	M8 FW
2	M8 HD FLAT WASHER	M8 FLAT WASHER - High Tensile 19x8x1.9mm
8	M8 FLAT WASHER - BLACK ZINC	M8 FLAT WASHER, 16.5x8.4x1.2, ISO4042 ZnNi BLACK PASSIVATED FINISH
6	M8 FLANGE NUT	Flange Nut, M8x1.25 G8.8 ZP
4	M10 x 25	Bolt Hex, M10X25x[1.5], GR8.8 ZP
4	M10 FW LHD	WASHER, FLAT M10X28.5X2.5
4	M10 FLANGE NUT	Flange Nut, M10x1.5 G8.8 ZP
16	M12X30	Bolt Hex, M12X30x1.75, GR8.8 ZP
6	M12X120	Bolt Hex, M12X120x1.75, GR8.8 ZP
4	M12X130	Bolt Hex, M12X130x1.75, GR8.8 ZP
28	M12 FW LHD	M12 FW Large Heavy Duty
24	M12 FLANGE NUT	Flange Nut, M12x1.75 G8.8 ZP
2	M12 Nyloc nut	M12 NYLOC NUT
4	T-0060	Silverado 1500 Crush Tube 75mm
2	T-0061	Silverado 1500 Crush Tube 95mm
2	NP-COM-M8-200-ASM0	M8 Nut Plate 200mm
2	NP-COM-M10-190-SLIM	Nut Plate M10 Slim - Suit DMAX Predator
2	NP-COM-M12-300- ASM0	M12 NUT PLATE 300MM STEM

TORO Fasteners – Contained in Small Parts Kit Bag

Qty	Part Number	Description
8	M4x12 PAN	SCREW, PAN HEAD PHILLIPS, M4X12X0.7 GR4.6 ZP
8	M4 FLAT WASHER	Flat Washer M4, 8mmODx0.8mm T
8	M4 FLANGE NUT	Flange Nut, M4
4	M5X15 BHCS BZP	SCREW, BUTTON HEAD CAP, M5X15X0.8 GR12.9 ISO4042 ZnNi BLACK PASSIVATED FINISH
4	M5 Flat washer	M5 FW
4	M5 Flat washer BZP	M5 Flat Washer, 10x5.3x1, ISO4042 ZnNi BLACK PASSIVATED FINISH
2	M5 FLANGE NUT	Flange Nut, M5x0.8 G8.8 ZP
4	M6 X 12 HEX	M6X12 HEX BOLT, ZP, 8.8
3	M6 X 20 HEX	M6X20 HEX BOLT, ZP, 8.8
27	M6x16 BHCS BLACK ZINC	SCREW, BUTTON HEAD CAP, M6X16X1 GR12.9, ISO4042 ZnNi BLACK PASSIVATED FINISH
7	M6 FLAT WASHER	M6 FW
27	M6 FLAT WASHER BLACK ZINC	M6 Flat Washer, 12x6.1x1, ISO4042 ZnNi BLACK PASSIVATED FINISH
20	M6 FLANGE NUT	Flange Nut, M6x1 G8.8 ZP
14	M6CN3MM	CAGE NUT M6x2.6-3.5
4	M8 X 12 HEX	Bolt Hex, M8X12x1.25, GR8.8 ZP
4	M8 X 20 HEX	Bolt Hex, M8X20x1.25, GR8.8 ZP
4	M8 X 16 BHCS BZP	SCREW, BUTTON HEAD CAP, M8X16X1.25 GR12.9, ISO4042 ZnNi BLACK PASSIVATED FINISH
8	M8 X 20 BHCS BLACK ZINC	SCREW, BUTTON HEAD CAP, M8X20X1.25, ISO4042 ZnNi BLACK PASSIVATED FINISH
6	M8 FLAT WASHER	M8 FW
2	M8 HD FLAT WASHER	M8 FLAT WASHER - High Tensile 19x8x1.9mm
12	M8 FLAT WASHER - BLACK ZINC	M8 FLAT WASHER, 16.5x8.4x1.2, ISO4042 ZnNi BLACK PASSIVATED FINISH
6	M8 FLANGE NUT	Flange Nut, M8x1.25 G8.8 ZP
4	M10 x 25	Bolt Hex, M10X25x[1.5], GR8.8 ZP
4	M10 FW LHD	WASHER, FLAT M10X28.5X2.5
4	M10 FLANGE NUT	Flange Nut, M10x1.5 G8.8 ZP
16	M12X30	Bolt Hex, M12X30x1.75, GR8.8 ZP
6	M12X120	Bolt Hex, M12X120x1.75, GR8.8 ZP
4	M12X130	Bolt Hex, M12X130x1.75, GR8.8 ZP
28	M12 FW LHD	M12 FW Large Heavy Duty
24	M12 FLANGE NUT	Flange Nut, M12x1.75 G8.8 ZP
2	M12 Nyloc nut	M12 NYLOC NUT
4	T-0060	Silverado 1500 Crush Tube 75mm
2	T-0061	Silverado 1500 Crush Tube 95mm
2	NP-COM-M8-200-ASM0	M8 Nut Plate 200mm
2	NP-COM-M10-190-SLIM	Nut Plate M10 Slim - Suit DMAX Predator
2	NP-COM-M12-300- ASM0	M12 NUT PLATE 300MM STEM

TOOLS REQUIRED

The following tools will be required to install the product.

Hand Tools	Power Tools	Workshop Equipment
Metric Socket Set 10-19mm	Electric/Air Impact Driver (Optional)	Isopropyl Alcohol
Socket Extension Bar	Air Hacksaw	Rag
Metric Spanner Set 10-19mm	or	Cable Ties
Hex (Allen) Key Set 4-6mm	Oscillating Multi Tool	Sandpaper
Torx Key Set	or	Automotive adhesive sealant (eg. Sikaflex)
Trim Removal Tool	Angle Grinder	
Plastic Auto Trim Tool Set	or	
Flat Blade Screwdriver Set	Jigsaw	
Phillips Head Screwdriver Set		
Utility Knife		
Side Cutters		
Pliers		

WORKSHOP SAFETY

It is the responsibility of the installer to always complete works in a safe manner. Make sure the following safety equipment is available and precautions are observed whilst fitting this product.

<p>Hearing Protection</p> 	<p>Always wear ear protection when using power tools.</p>
<p>Eye Protection</p> 	<p>Ensure eye protection is always worn when cutting or drilling.</p>
<p>Manual Handling</p> 	<p>Do not attempt to lift bar assemblies or rock sliders on your own.</p> <p>Always use two people to lift or use mechanical Lifting aid such as hydraulic lifting trolley.</p>
<p>Vehicle Support</p> 	<p>Always ensure vehicle is properly supported when working on it. Do not attempt to fit products whilst suspension work is being carried out. Do not work under a vehicle supported only by a jack.</p>



1. Open the bonnet.
2. Remove the bonnet release handle by unscrewing the 2x T15 Torx screws.

TOOLS REQUIRED

T15 Torx Driver

FASTENERS

2x T15 Torx screw

Retain for Reassembly

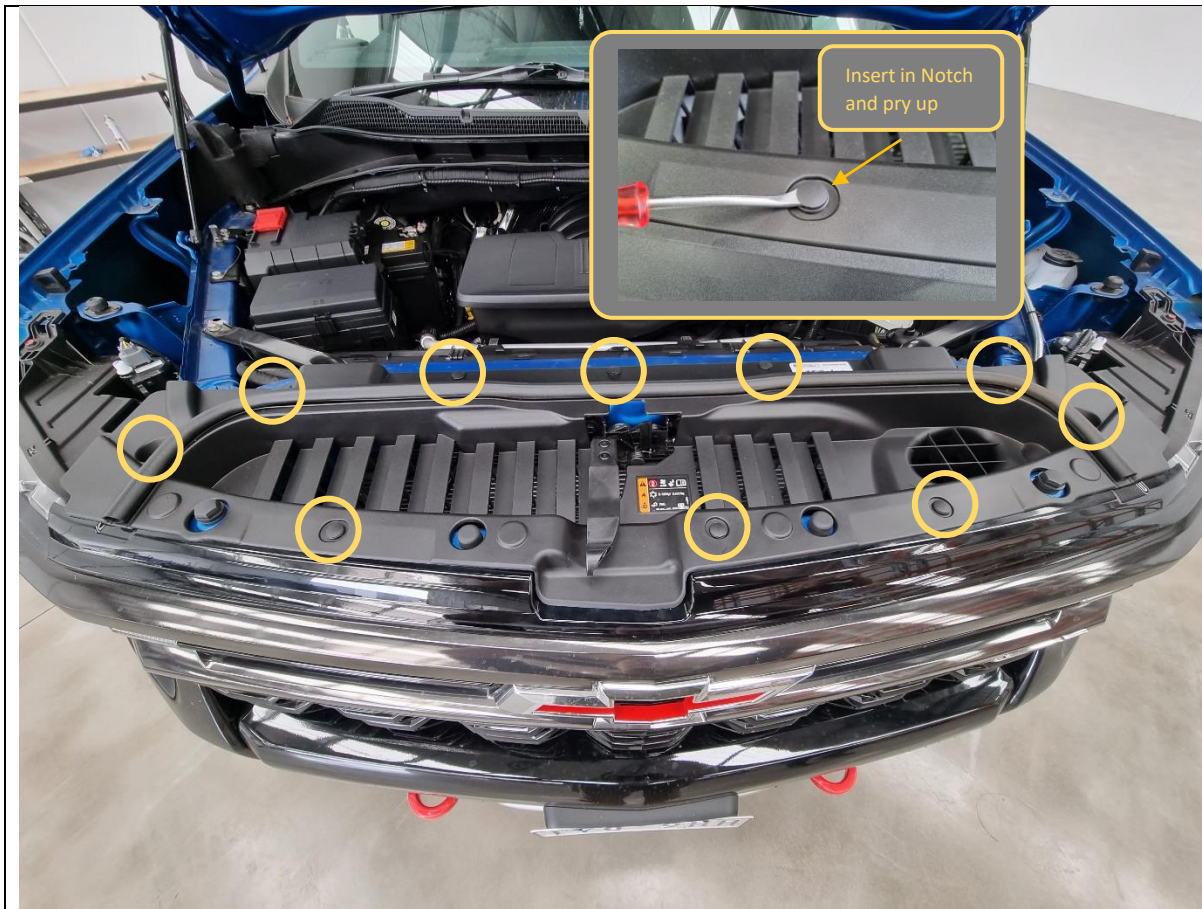

3. Remove 10x plastic push rivets securing the radiator grille cover, by levering centre section upwards using flat bladed screwdriver or trim tool, as shown.

TOOLS REQUIRED

Flat Blade Screwdriver or
Trim Tool

FASTENERS

10x Plastic Push Rivet

Retain for Reassembly



4. Remove 4x 10mm hex bolts on the top edge of the grille.

TOOLS REQUIRED

10mm socket

FASTENERS

4x 10mm hex bolt

Retain for Reassembly



5. The grille is held in place with plastic clips throughout.

Insert a plastic trim removal tool under the side at the headlight and gently release the first clip.
6. Continue working around the grille to release most of the clips, either with the plastic trim tool or by pulling the grille outwards.

TOOLS REQUIRED

Plastic trim tool

FASTENERS

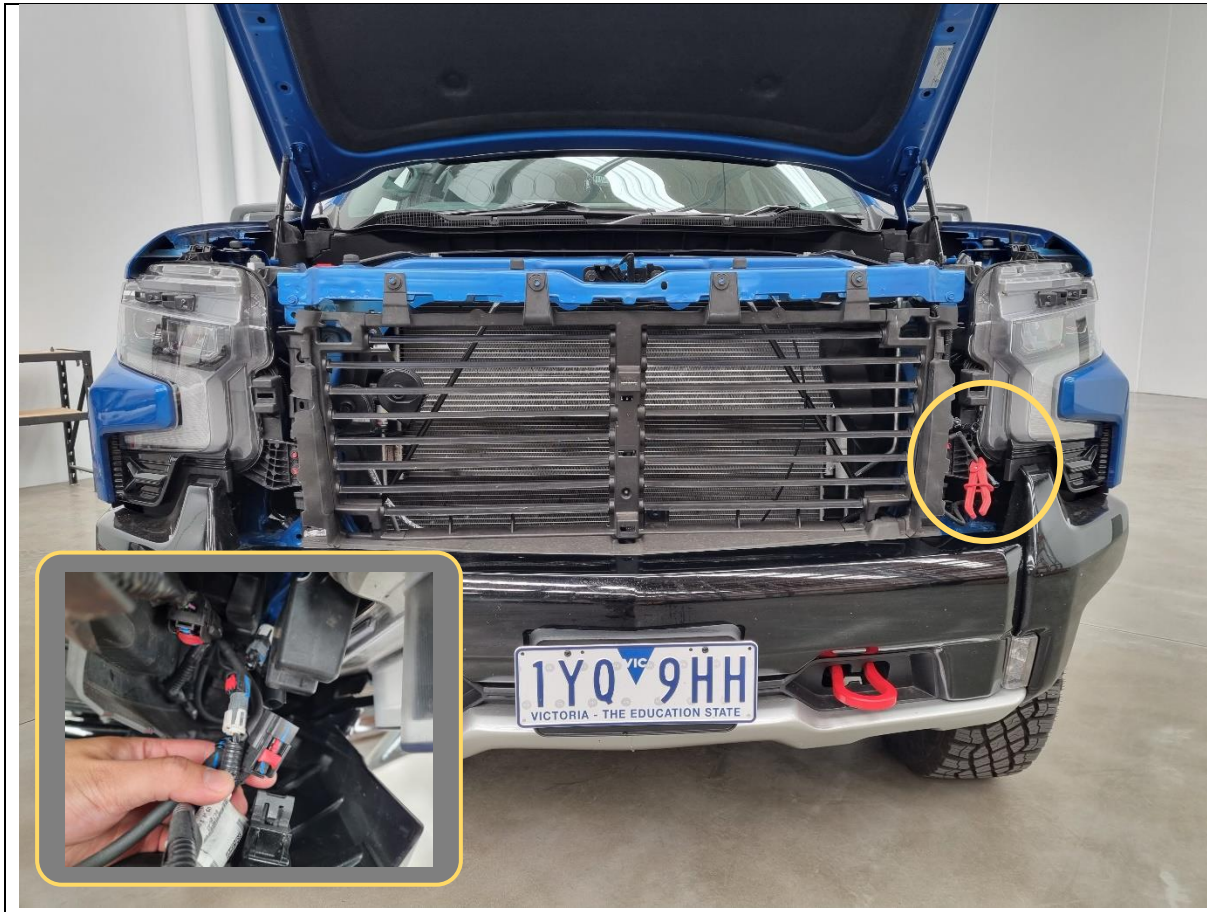

7. Pull the grille outwards to reveal the harness connections on the LH side near the headlight.
8. Disconnect the grille DRL cable, coaxial camera cable and washer hose for the camera. It is recommended to clamp the rubber washer hose to prevent fluid spillage.
9. Once all cables are disconnected, fully remove the grille and set aside.

TOOLS REQUIRED

FASTENERS



- 10. Remove 5x T15 Torx screws securing the wheel arch liner to the bumper.
- 11. Repeat for the other side.

TOOLS REQUIRED

T15 Torx Driver

FASTENERS

10x T15 screw

Retain for Reassembly

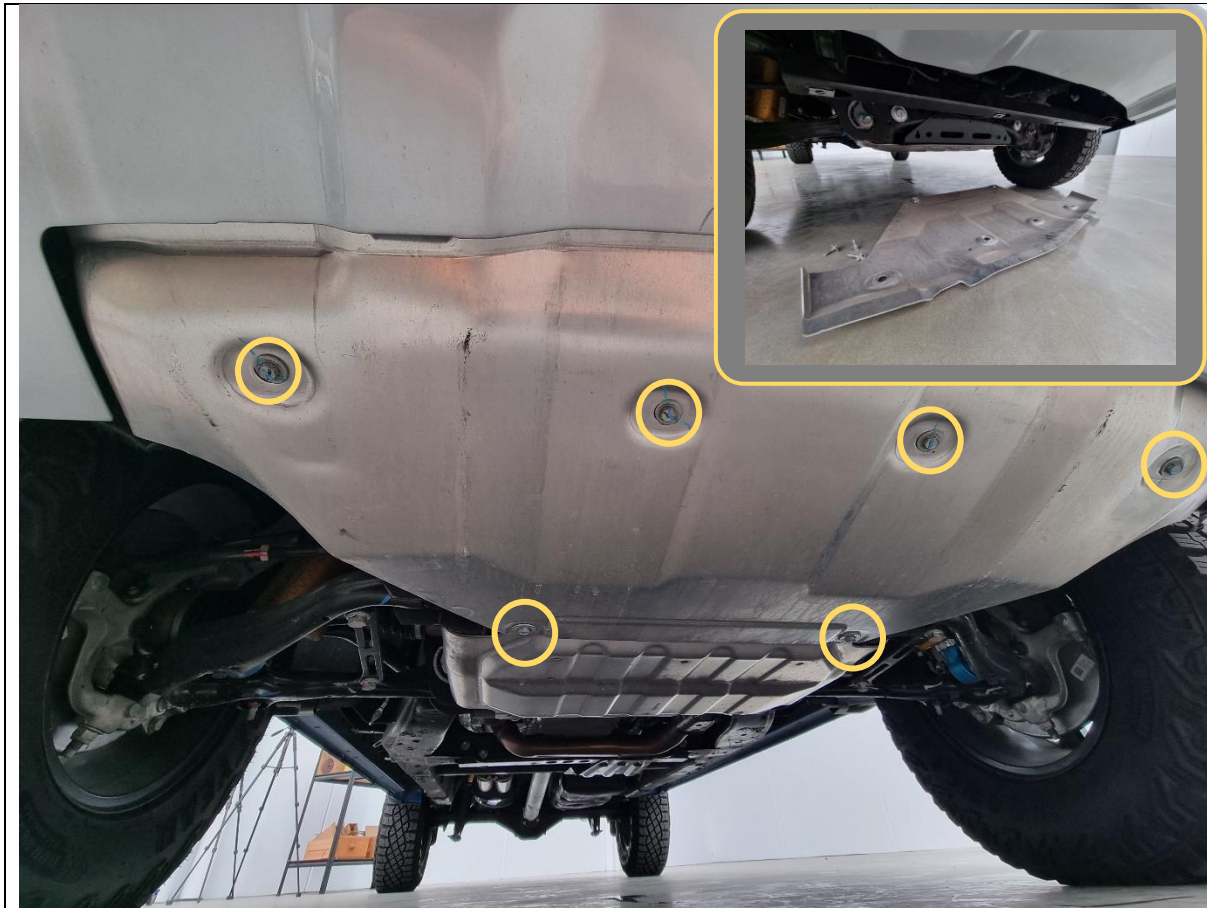

12. Remove 6x M8 bolts securing the bash plate to the vehicle, then remove and discard bash plate.

TOOLS REQUIRED

13mm socket/spaamer

FASTENERS

6x M8 hex head bolts

Retain for reassembly

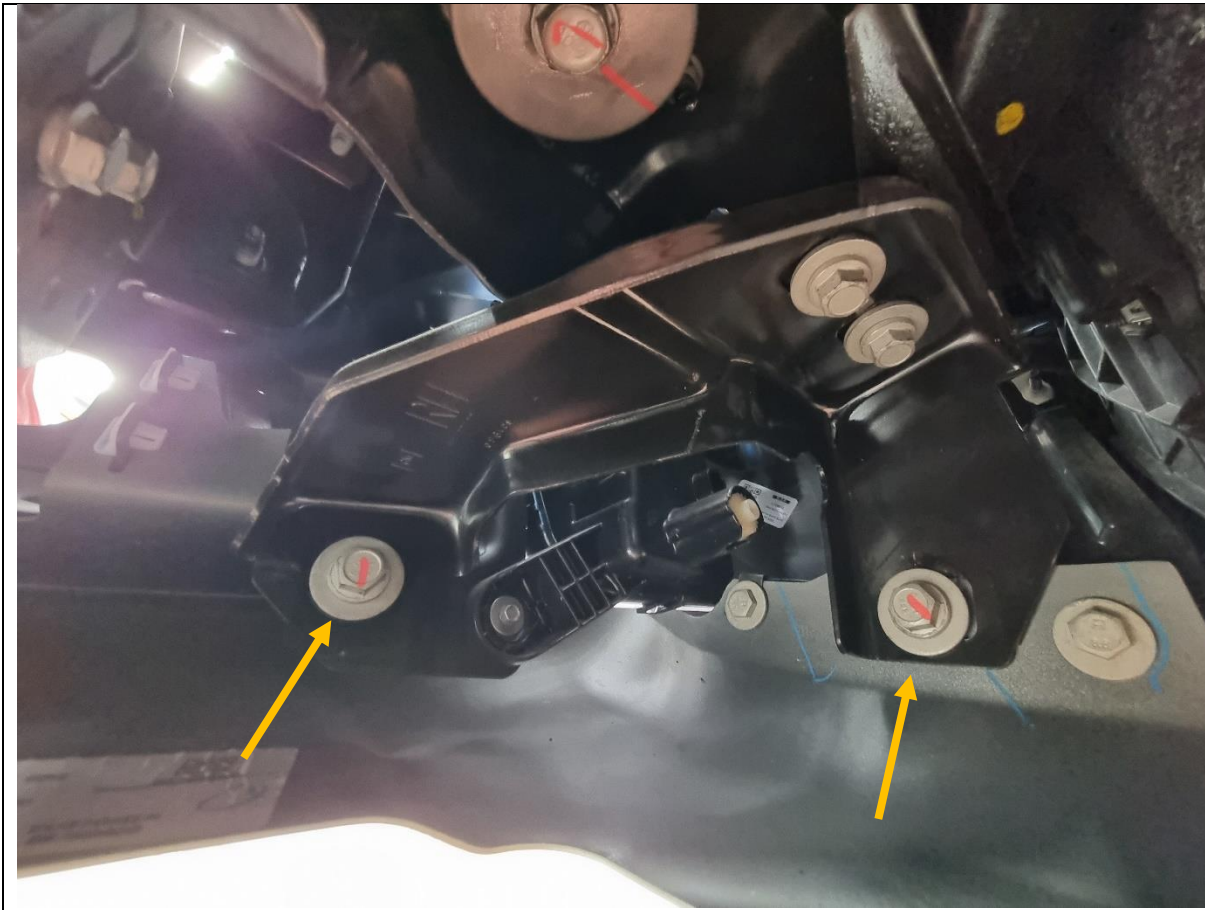

13. From underneath the vehicle, remove the 2x 15mm hex bolts (M10x35) for the outer bumper support bracket. Retain bolts for re-use later.

14. Repeat for the other side.

TOOLS REQUIRED

15mm socket

FASTENERS

4x M10x35 hex bolt
Retain for Reassembly



15. On the bumper support bracket next to the inside face of the chassis rail will be an 18mm hex bolt. Remove the 18mm hex bolt with a spanner.

16. Repeat for the other side.

TOOLS REQUIRED

18mm spanner

FASTENERS

2x 18mm hex bolt



17. On the top lip of the bumper, there are 2x hex bolts hidden behind a rubber cover panel, above where the inner bolts were from the previous step.

Remove the 18mm hex bolts securing the bumper to the chassis.

TOOLS REQUIRED

18mm socket/spanner

FASTENERS

2x 18mm hex bolt

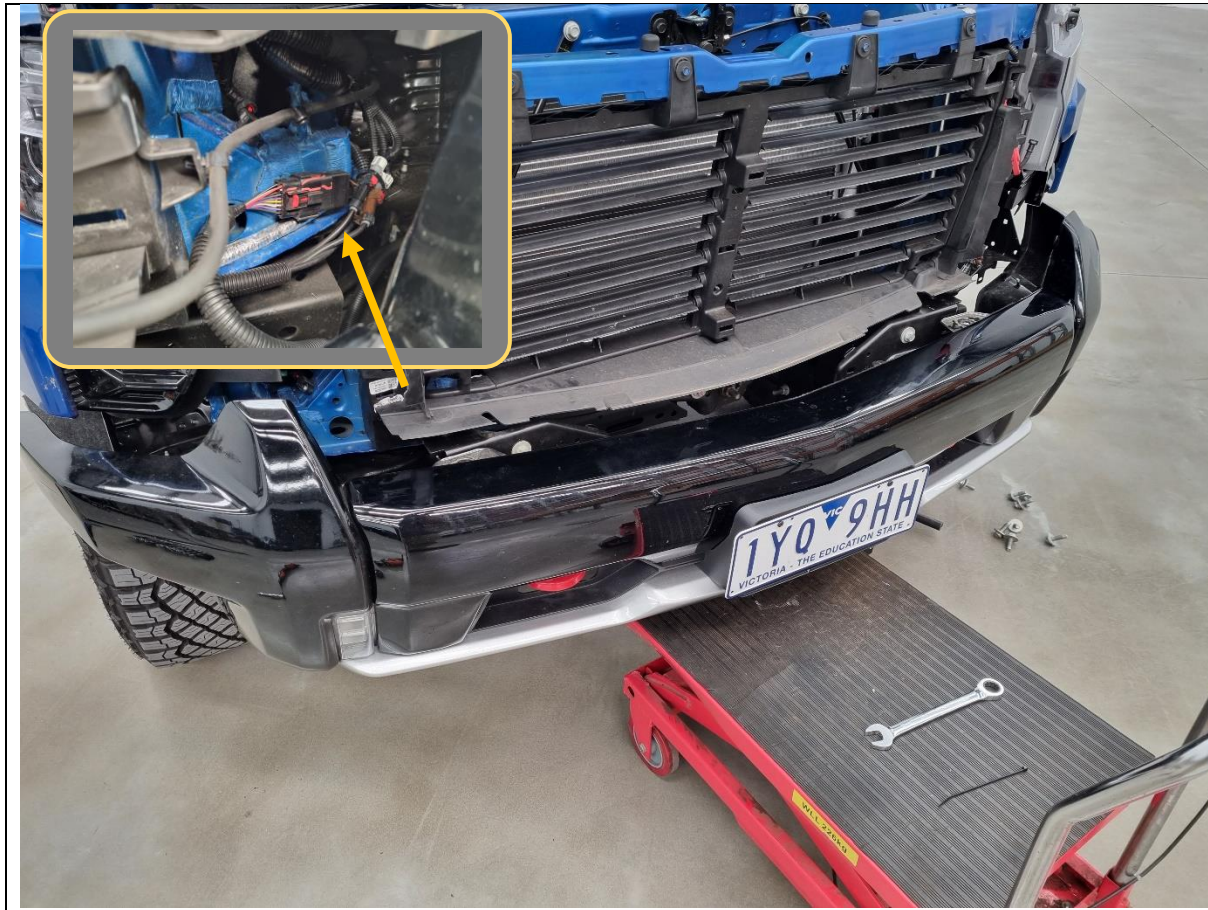

18. Support the bumper with a trolley or assistance from another person and pull outwards from the vehicle. Untuck the wheel arch liners from the bumper to do so.
19. Disconnect the bumper wiring harness on the passenger side underneath the headlight (RH for Aus, LH for US vehicles).
20. Fully remove the bumper and set aside.

TOOLS REQUIRED

FASTENERS

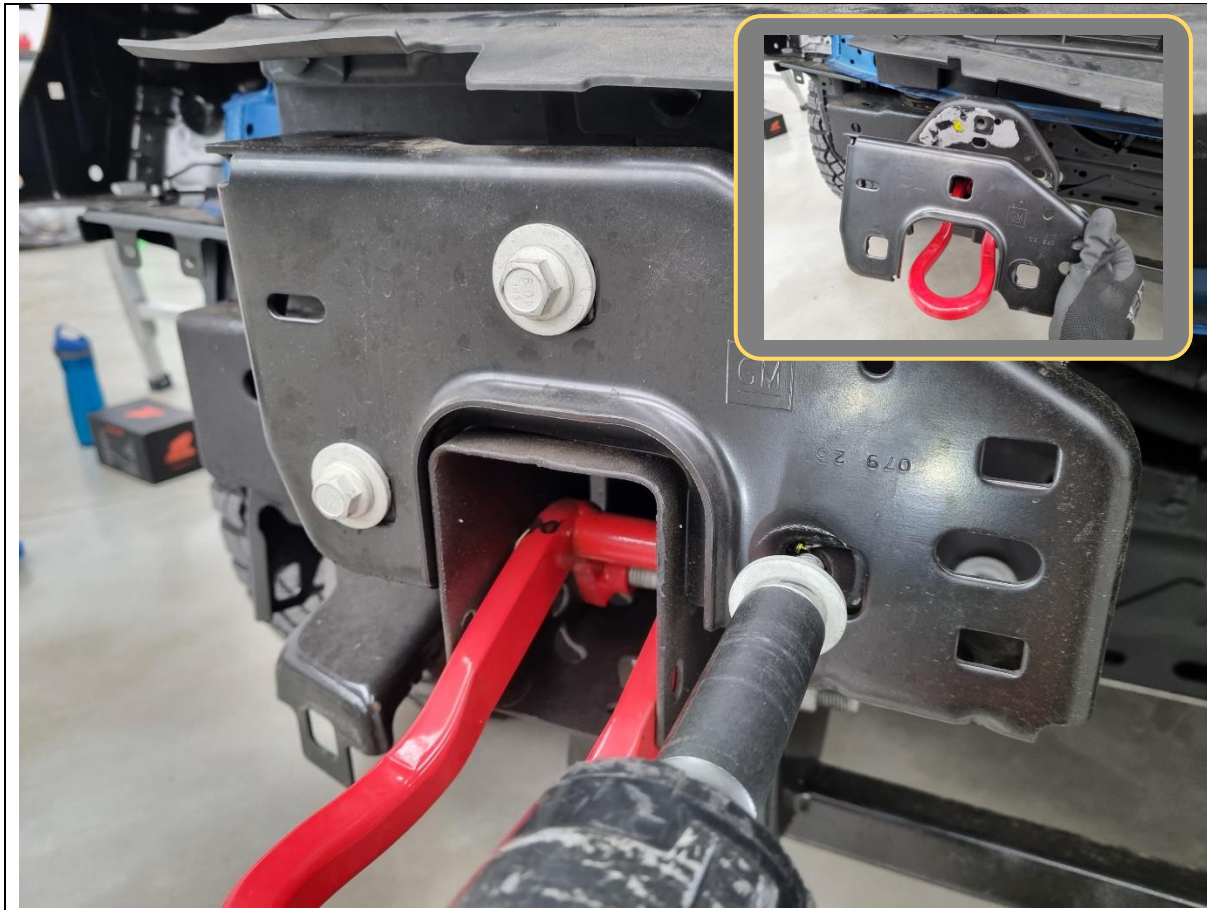

21. Remove the 3x 15mm hex bolts (M10x35) securing the bumper bracket to the chassis. Retain bolts for re-use.
22. Repeat on other side.

TOOLS REQUIRED

15mm socket/spanner

FASTENERS

6x M10x35 hex bolt

Retain for Reassembly

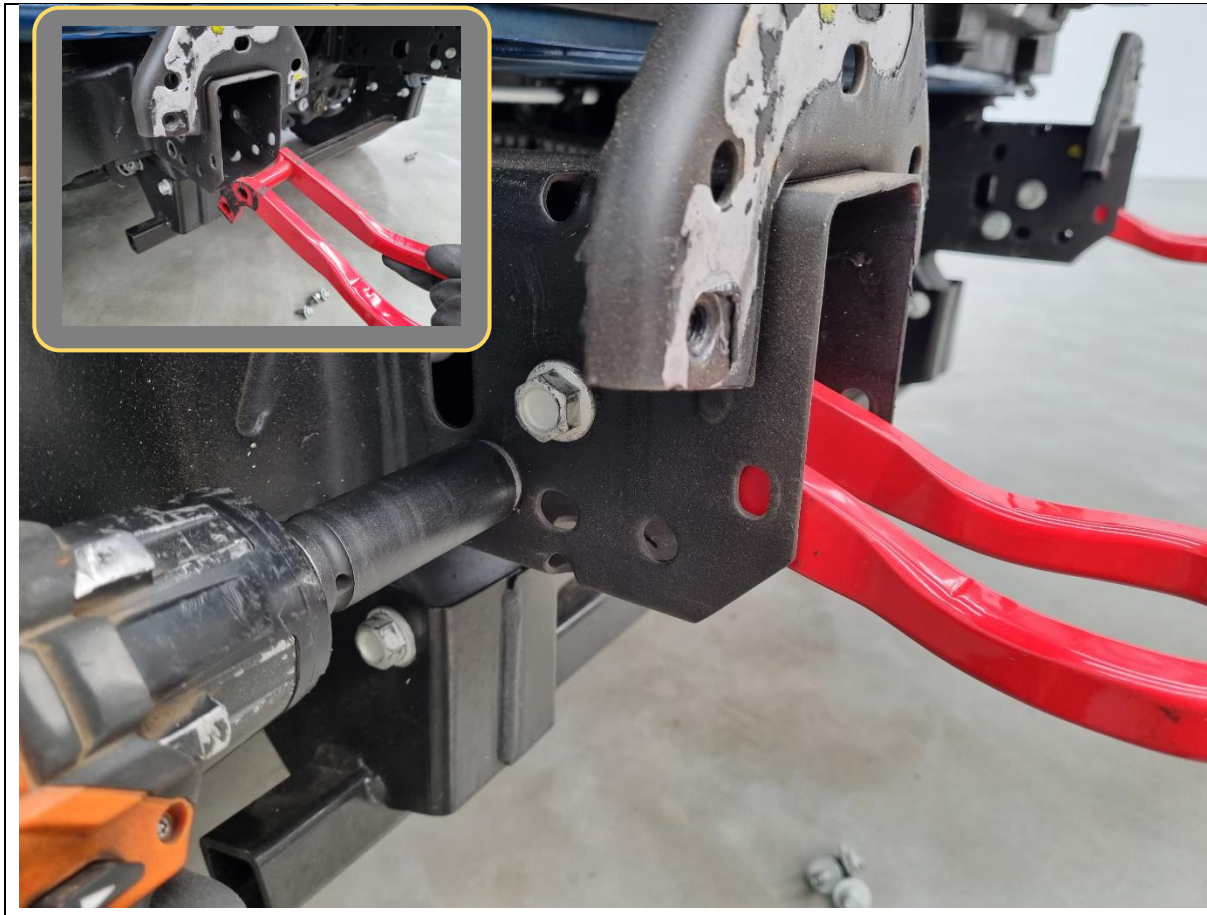

23. Remove the 2x 18mm hex bolts (M12x40 and M12 long) securing the tow hook to the chassis. Retain bolts for re-use.

24. Repeat for the other tow hook.

TOOLS REQUIRED

18mm socket/spanner

FASTENERS

2x M12x40 hex bolt
Retain for Reassembly

2x M12 hex bolt (long)

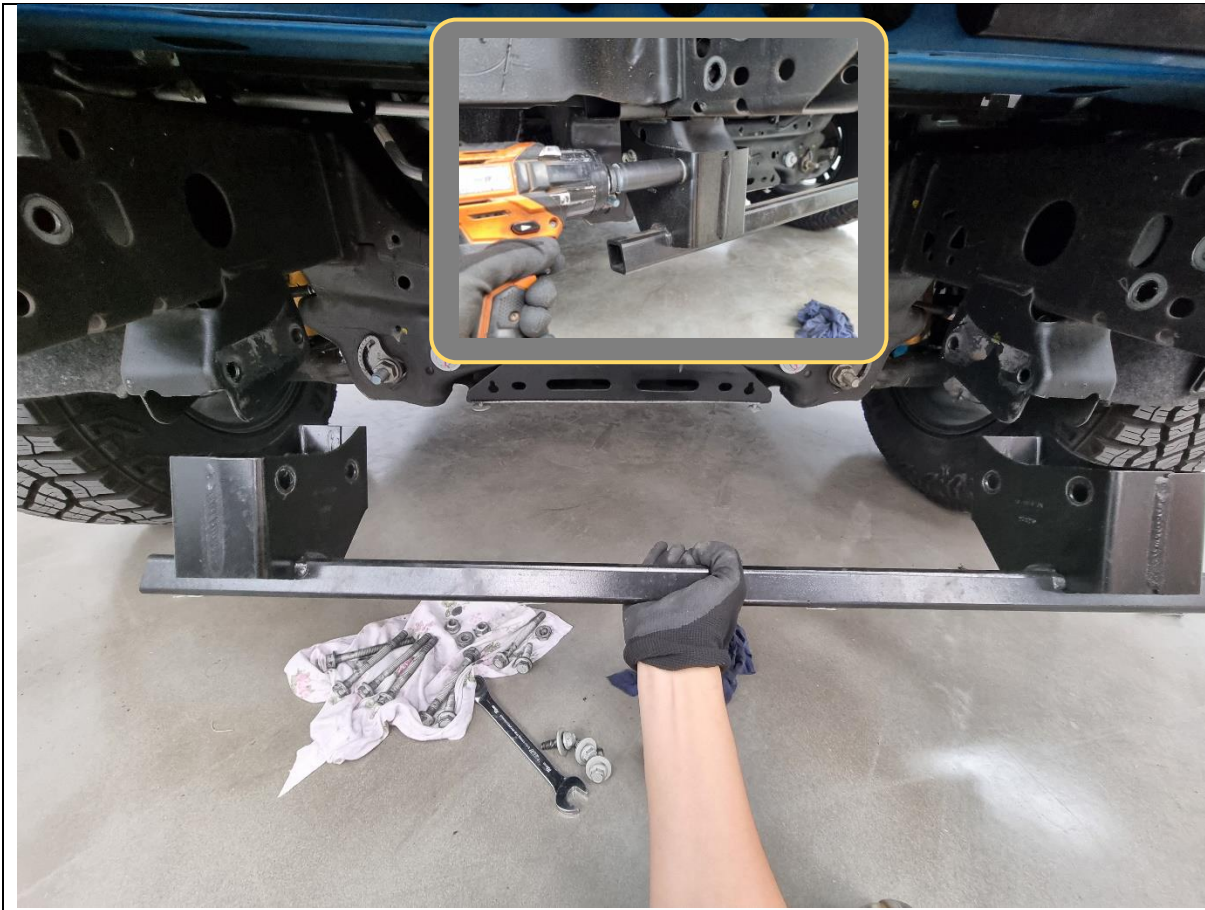

25. Remove the 4x 18mm hex bolts (2x per side) securing the bash plate reinforcement member to the chassis.

TOOLS REQUIRED

18mm socket/spanner

FASTENERS

4x 18mm hex bolt

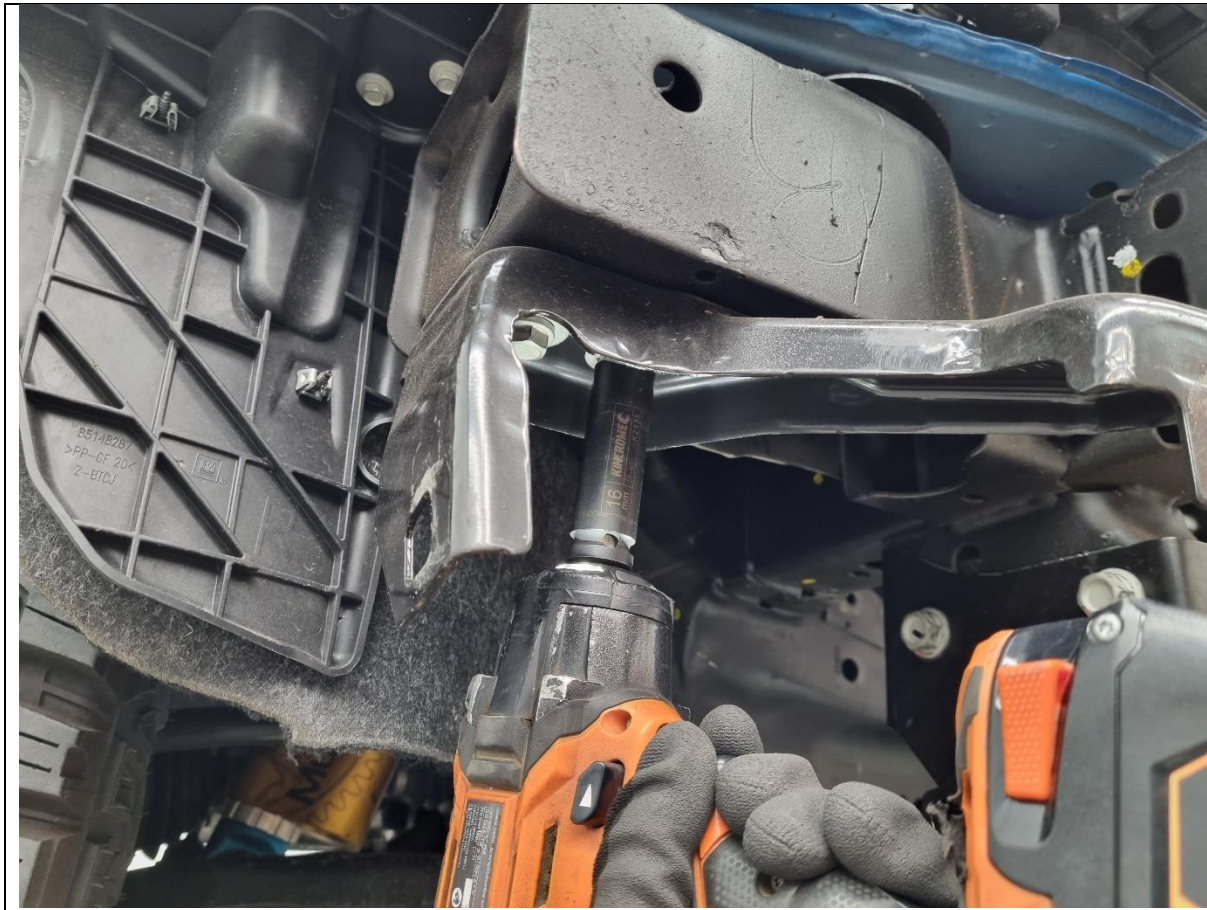

- 26. Remove the 2x 15mm hex bolts securing the bumper support bracket to the chassis. Retain bolts for re-use.
- 27. Repeat for both sides.

TOOLS REQUIRED

15mm socket/spanner

FASTENERS

4x 15mm hex bolt

Retain for Reassembly

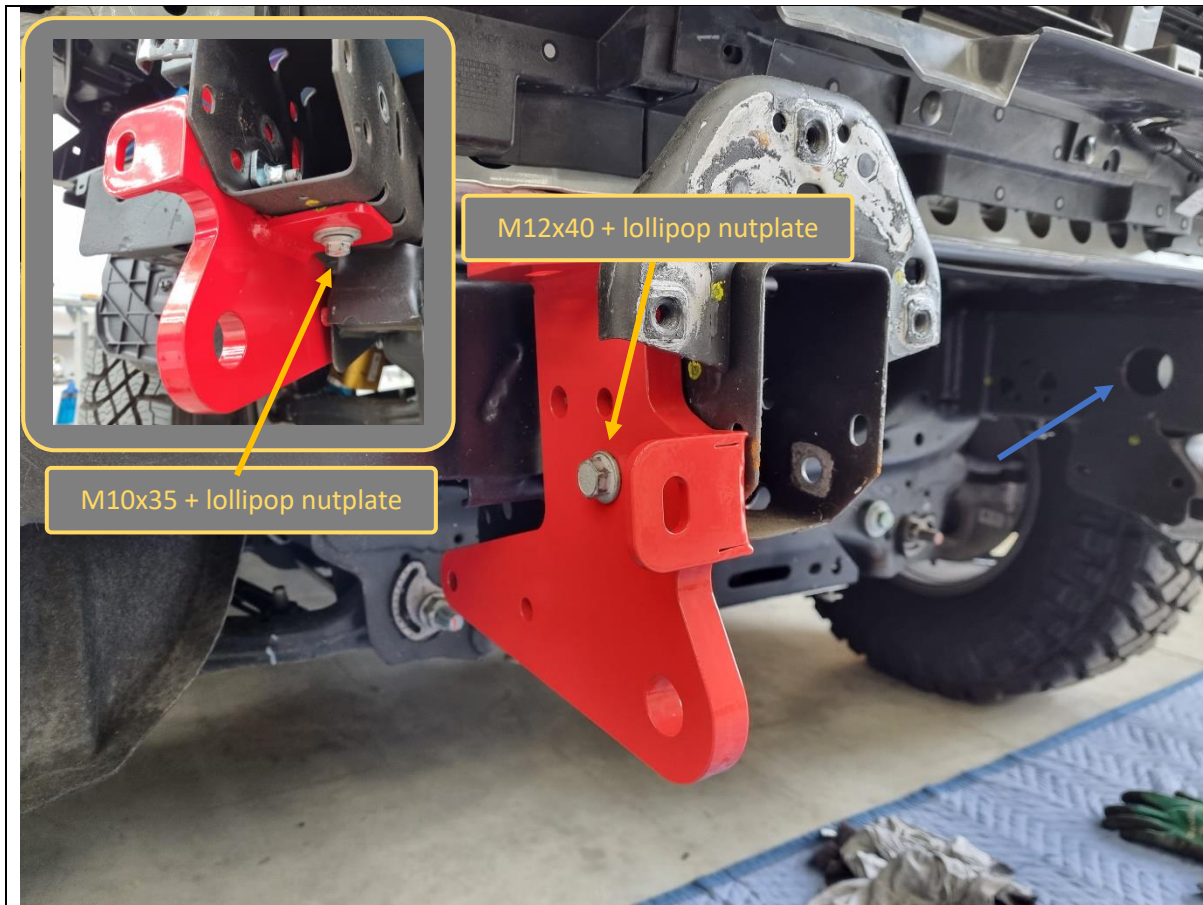

28. Fit the RH tow point to the vehicle using the retained factory M12x40 hex bolt (from Step 23) + M12 nutplate on the side and factory M10x35 hex bolt (from Step 13) + M10 nutplate on the bottom.

The lollipop nutplates can be insert through the open hole on the inside of the chassis (see blue arrow for reference).

TOOLS REQUIRED

15mm socket
18mm socket

FASTENERS

1x factory M10x35 hex bolt
1x M10 lollipop nutplate

1x factory M12x40 hex bolt
1x M12 lollipop nutplate

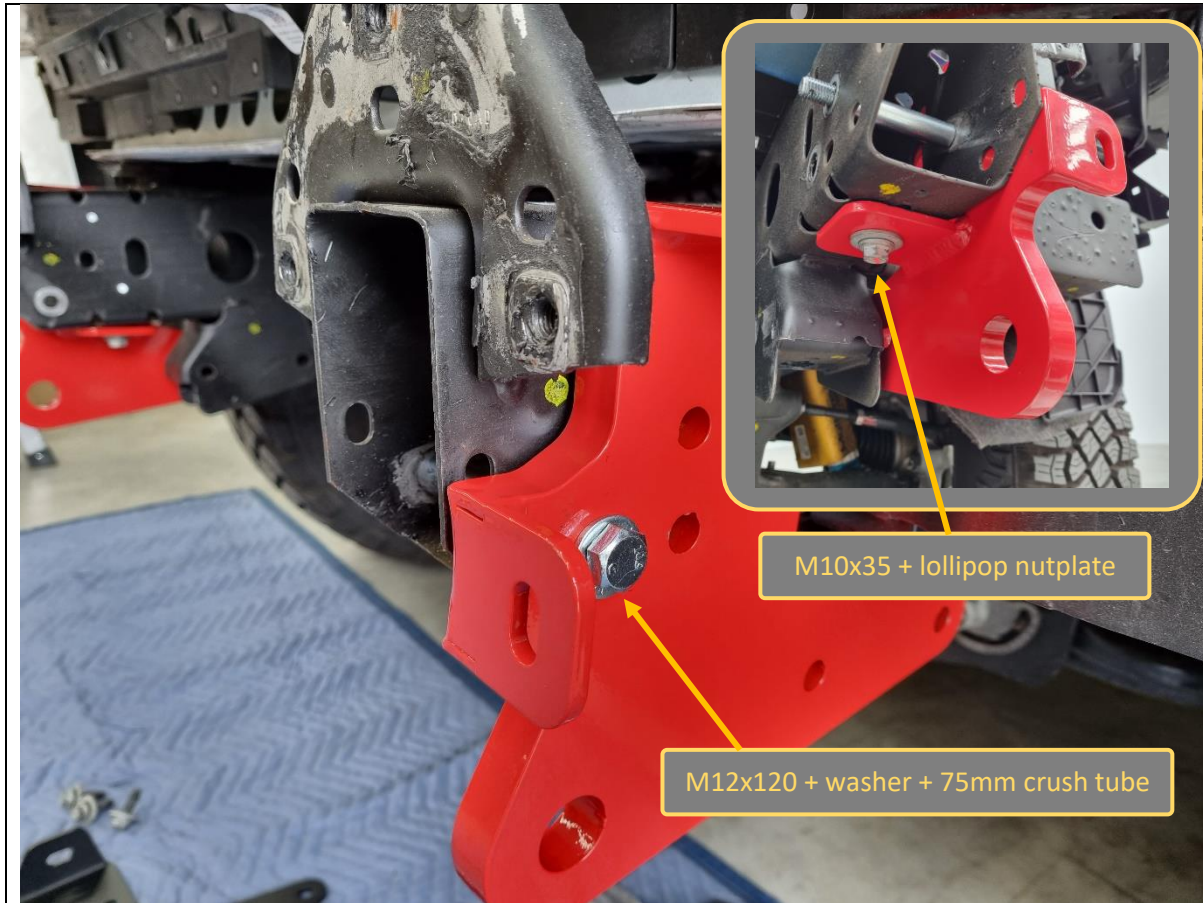

- 29. Fit the LH tow point to the vehicle using the retained factory M10x35 hex bolt (from Step 13) + M10 nutplate on the bottom.
- 30. Also loosely fit the tow point in place using 1x M12x120, flat washer and 75mm crush tube through the side. Do not secure with nut yet.

TOOLS REQUIRED

- 15mm socket
- 18/19mm socket

FASTENERS

- 1x factory M10x35 hex bolt
- 1x M10 lollipop nutplate
- 1x M12x120 hex bolt
- 1x M12 flat washer
- 1x 75mm crush tube

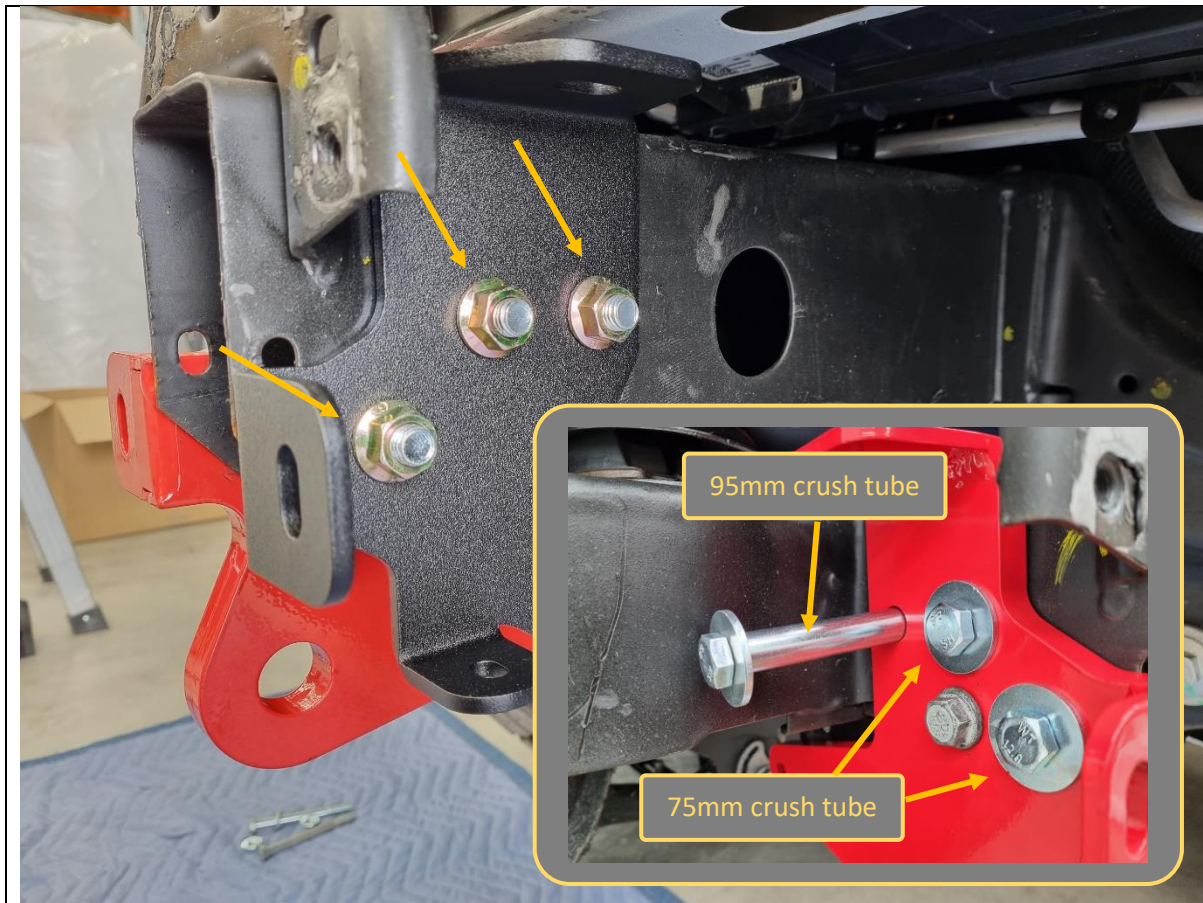

31. Fit the RH chassis mount brace bracket to the inside of the RH chassis rail and secure with 3x M12x120 hex bolt, 3x flat washer, 2x 75mm crush tube, 1x 95mm crush tube and 3x flange nut.

TOOLS REQUIRED

18/19mm socket

FASTENERS

3x M12x120 hex bolt
3x M12 flat washer
2x 75mm crush tube
1x 95mm crush tube
3x M12 flange nuts

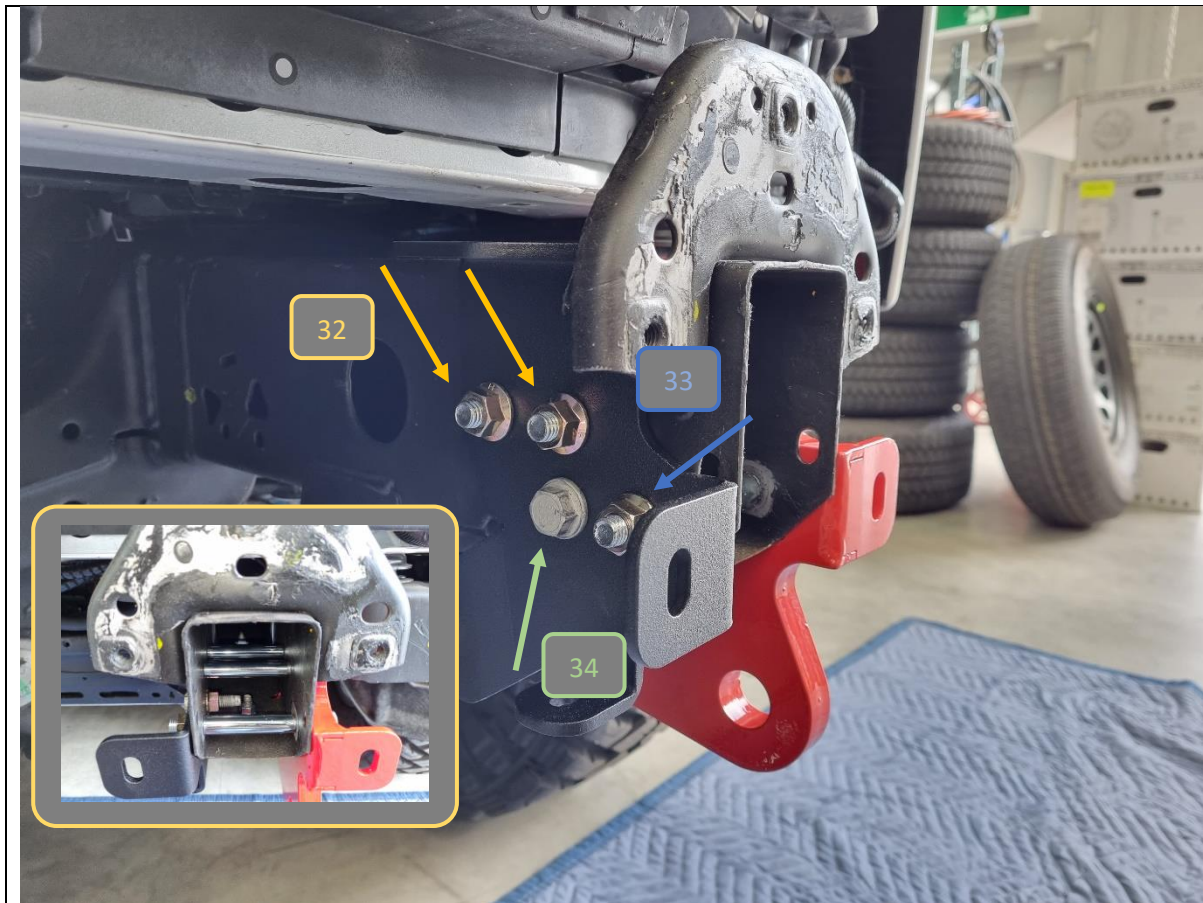

- 32. Fit the LH chassis mount brace bracket to the inside of the LH chassis rail and secure with 2x M12x120 hex bolt, 2x flat washer, 1x 75mm crush tube, 1x 95mm crush tube and 2x flange nut.
- 33. Secure the loose M12x120 from Step 30 with an M12 flange nut.
- 34. Fit the retained factory M12x40 hex bolt (from Step 24) + M12 nutplate on the side.

TOOLS REQUIRED

18/19mm socket

FASTENERS

2x M12x120 hex bolt
2x M12 flat washer
1x 75mm crush tube
1x 95mm crush tube
3x M12 flange nuts

1x factory M12x40 hex bolt
1x M12 lollipop nutplate

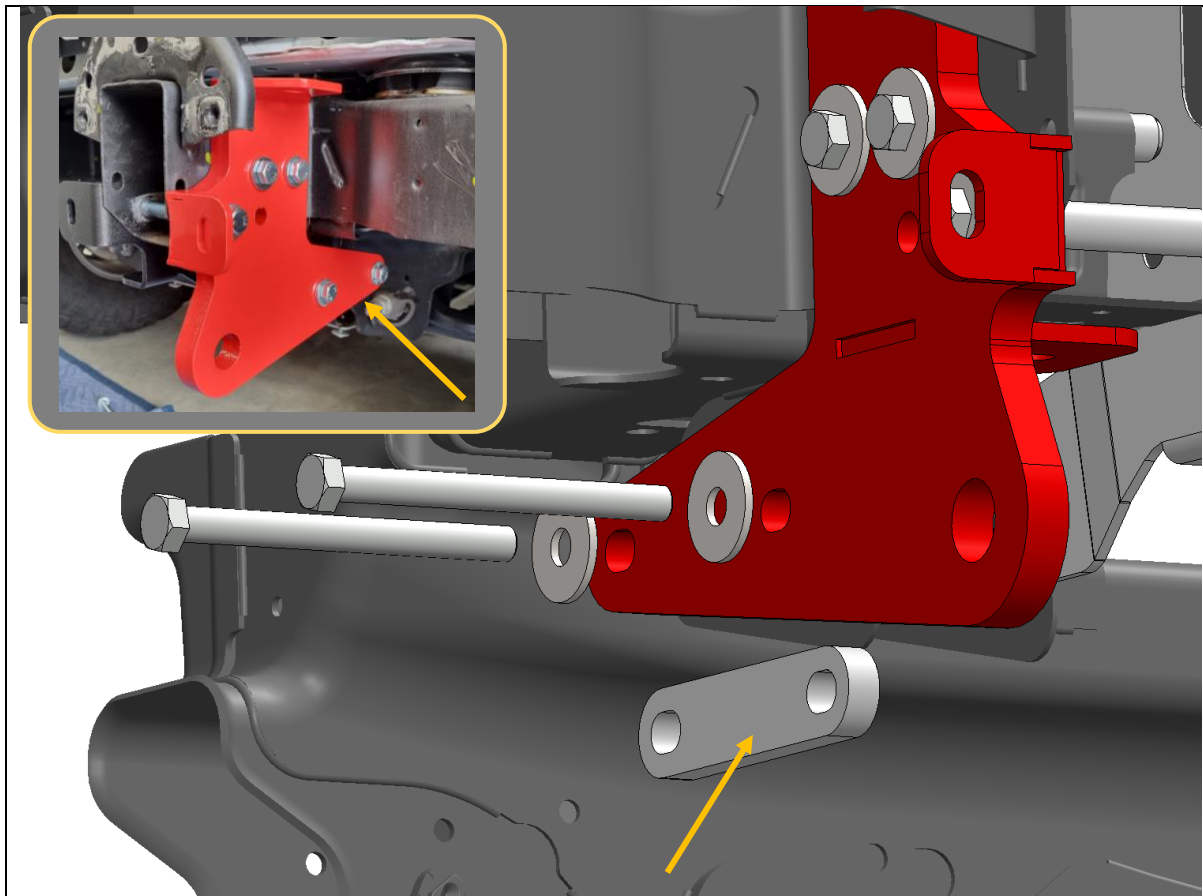

35. Insert the rear tow point spacer plate between the tow point and chassis at the rear, then loosely secure with 2x M12x130 hex bolts, flat washers and flange nuts.

Keep bolts finger tight at this stage.

36. Tighten all other fasteners in the tow point and chassis mount brace bracket, except for those 2x rear bolts.

37. Repeat for the LHS tow point.

TOOLS REQUIRED

15mm socket
18/19mm socket

FASTENERS

2x M12x130 hex bolt
2x M12 flat washer
2x M12 flange nuts

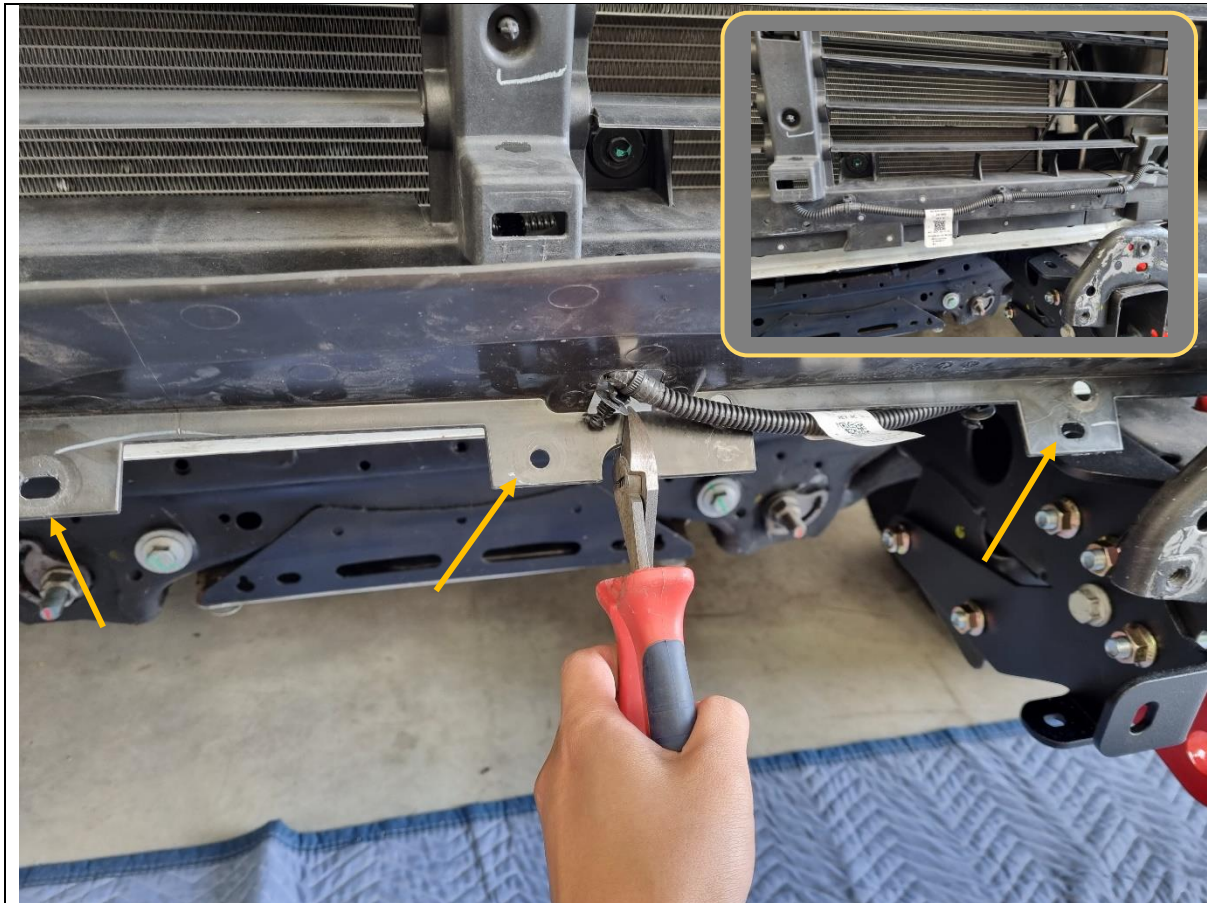

- 38. Remove the plastic push rivets securing the lower plastic air dam.
- 39. Unclip the wiring loom from the air dam, and then reclip the loom to the radiator louvre plastic frame, without the air dam.

TOOLS REQUIRED

Flat Blade Screwdriver or
Trim Tool

FASTENERS

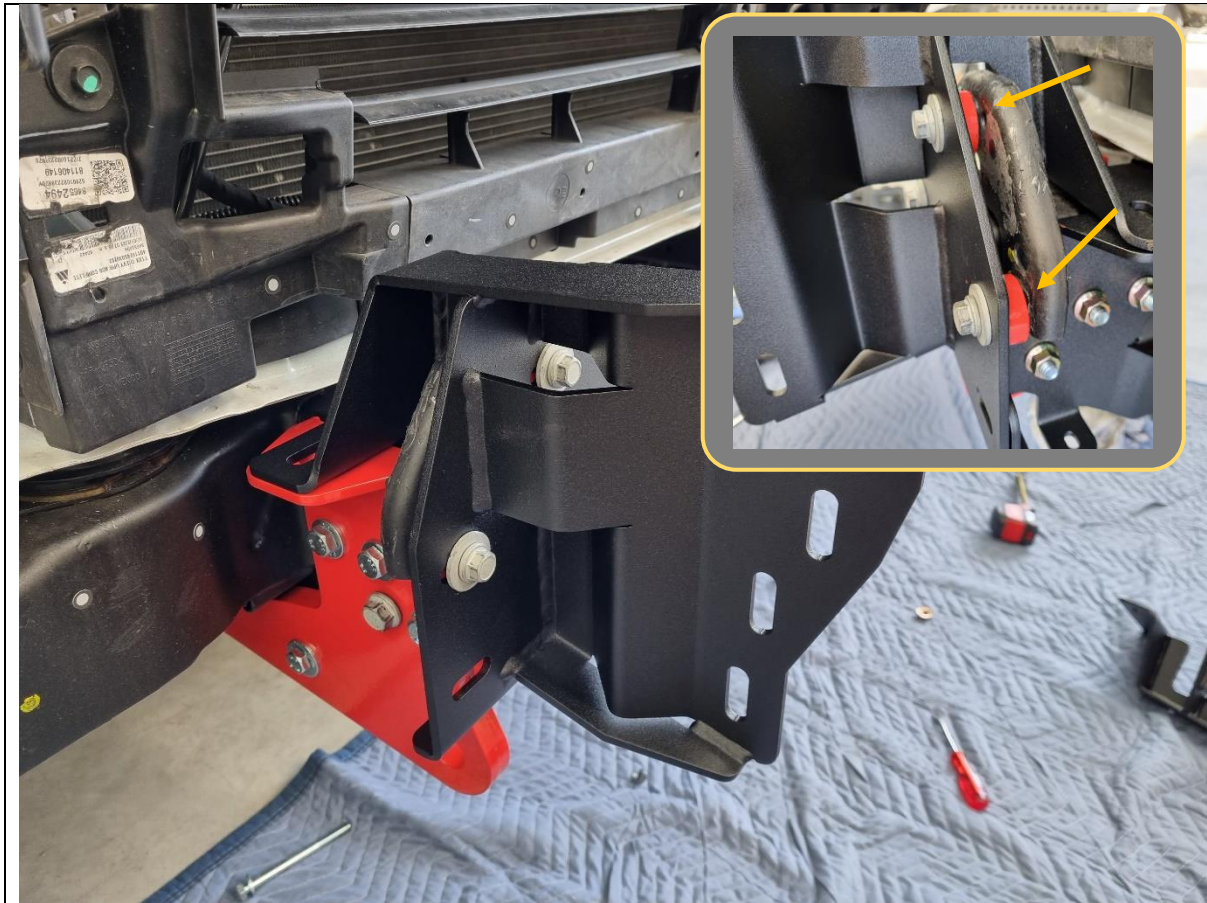

- 40. Slide the RH impact assembly from the side and onto the chassis.
- 41. Loosely secure to the chassis with 3x factory retained M10x35 hex bolts (from Step 21) and round tow point spacer blocks wedged inbetween (see inset).
- 42. Repeat for the LH impact assembly.

TOOLS REQUIRED

15mm socket

FASTENERS

6x factory M10x35 hex bolt

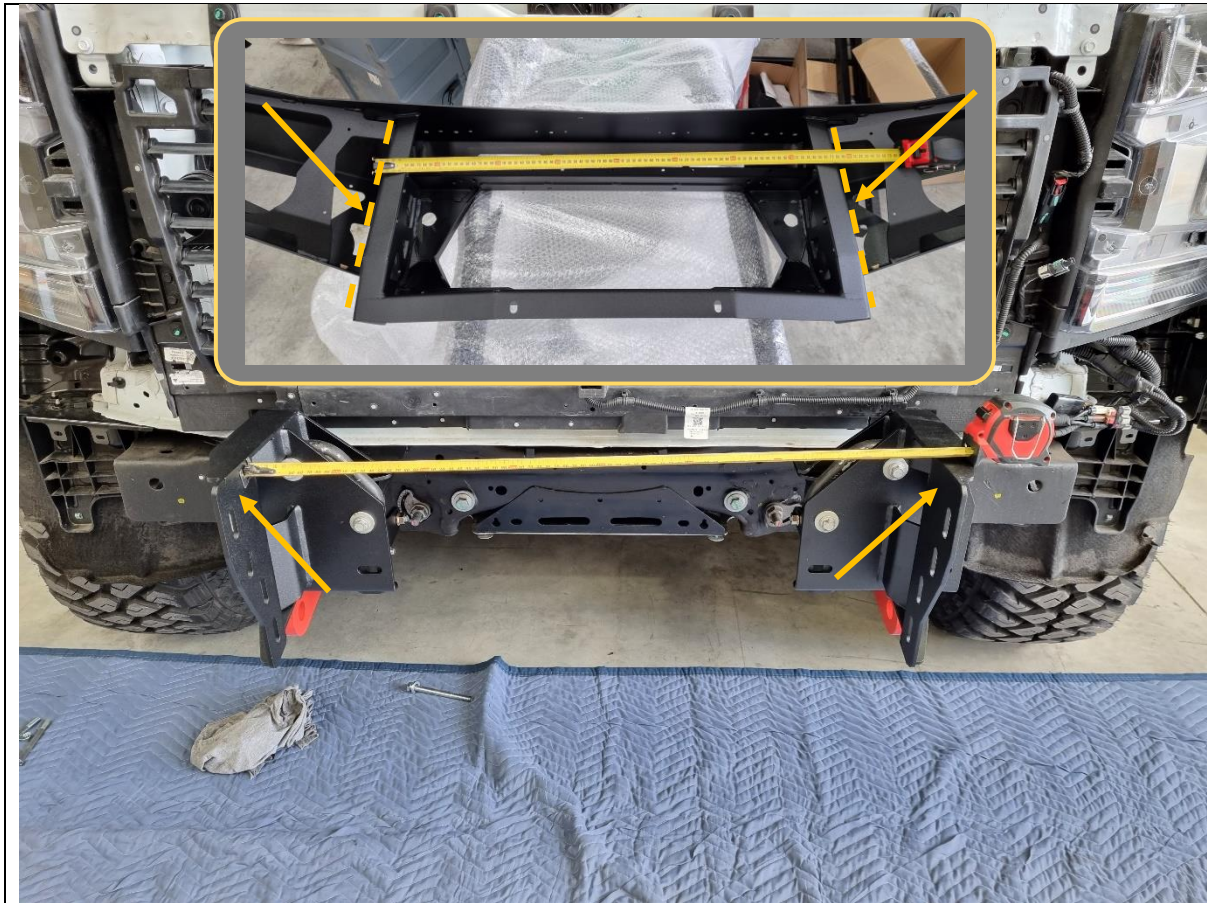

43. Measure the distance between the outside faces of uprights on bar using tape measure. Write distance below for reference if required.

Bar Upright Width = _____mm

44. Adjust mounts by sliding left/right on the slots, such that distance between inner faces of mounts are approximately 2mm more than bar. Ensure the mount faces are vertically upright and symmetric left/right on the chassis.

45. Secure and tighten mounts.

TOOLS REQUIRED

Tape measure

15mm socket

FASTENERS

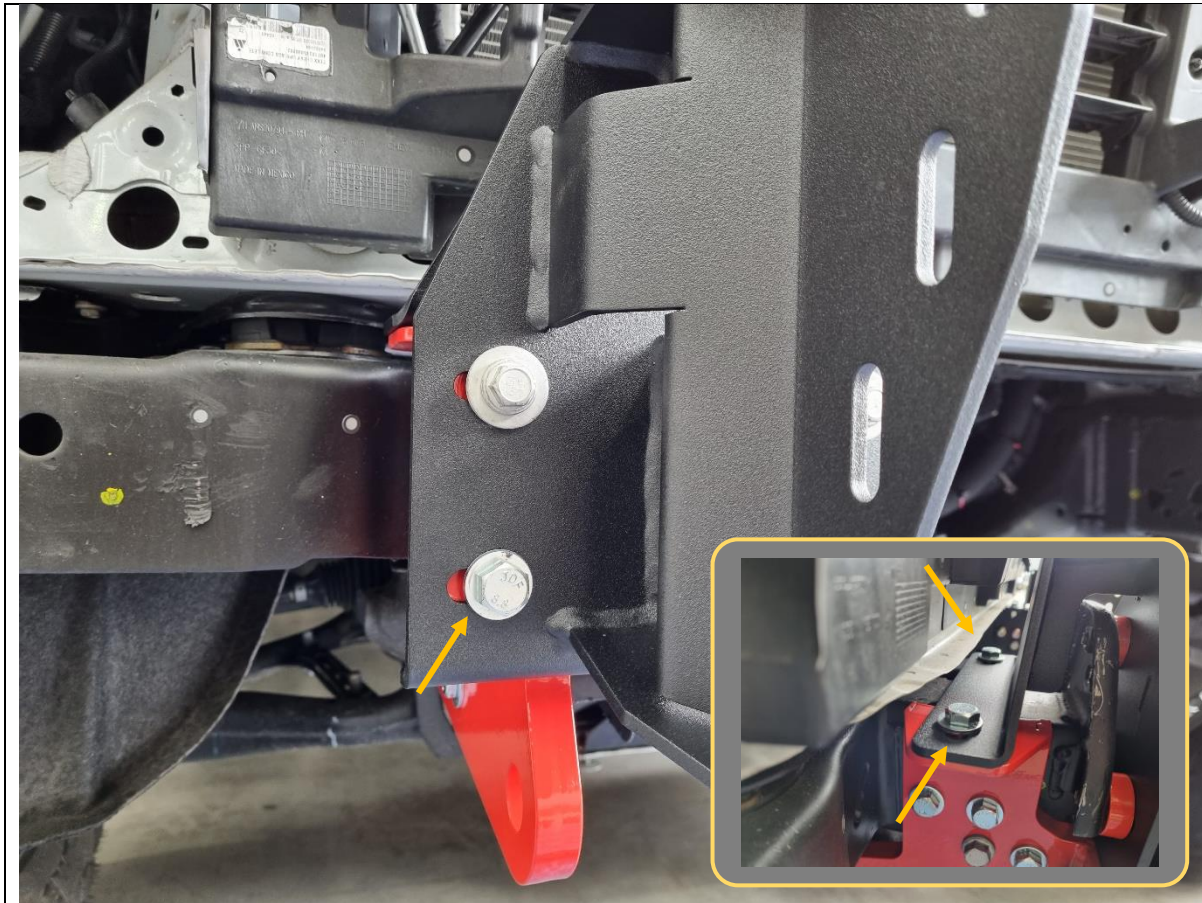

46. Fit remaining 4x M12x30 hex bolts, flat washers and flange nuts for the RH impact assembly.

The 2x bolts on the lower face can be tightened with a socket.

The 2x bolts on the top flange can be tightened with a spanner.

47. Repeat for the LH impact assembly.

TOOLS REQUIRED

18/19mm spanner
18/19mm socket

FASTENERS

8x M12x30 hex bolt
8x M12 flat washer
8x M12 flange nut

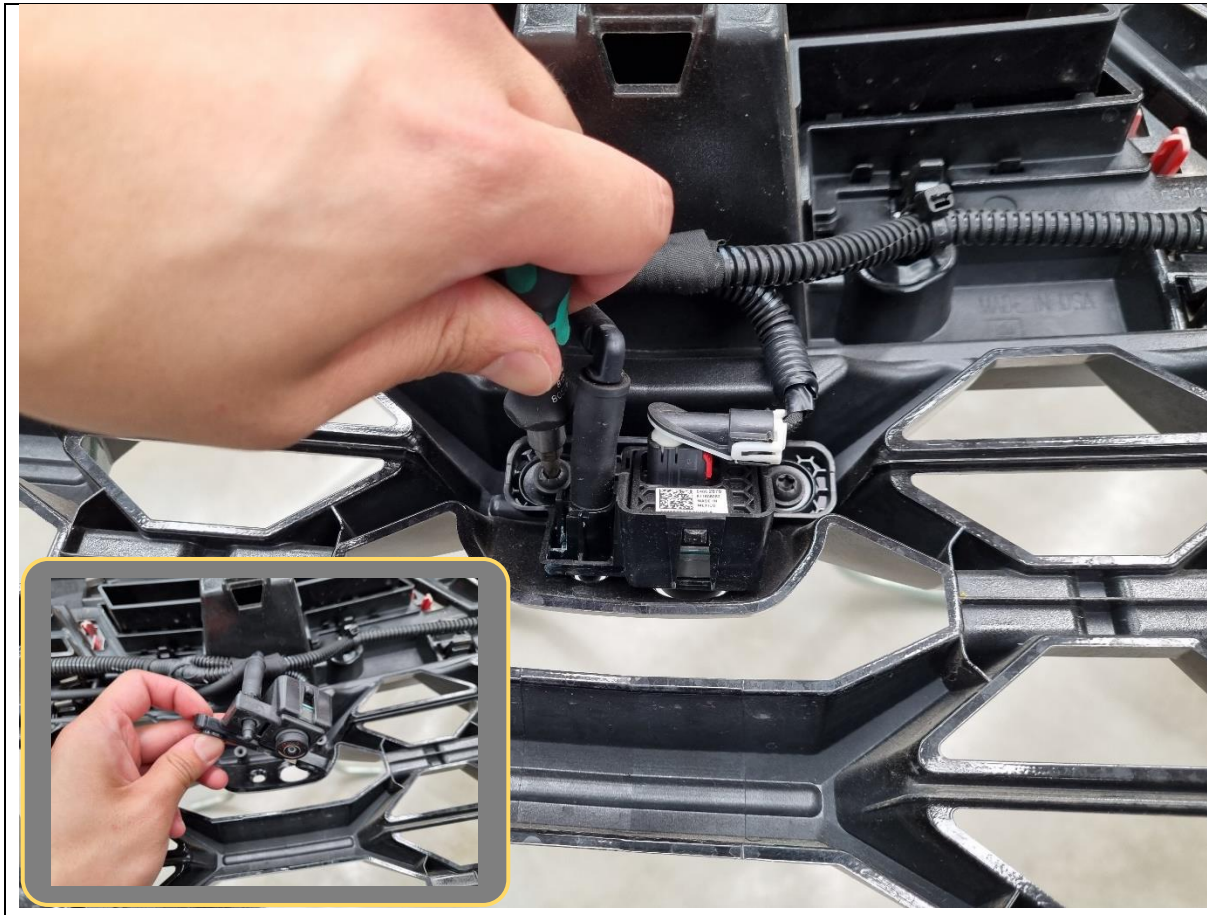

48. The front camera can be optionally relocated from the grille into the bar for a clearer unobstructed view. This is especially recommended if running optional driving lights or top tubes.

Unscrew the T20 Torx screws and separate the camera/washer and housing from the grille.

TOOLS REQUIRED

T20 Torx Driver

Trim Tool

FASTENERS



49. Unclip the rubber washer hose from the grille.

50. Pull apart the corrugated split tubing and separate the camera coaxial harness (circled, bottom left) from the grille DRL harness.

TOOLS REQUIRED

FASTENERS



51. Disconnect the camera harness and washer hose on the camera body side and reconnect the other end back to the vehicle. Set aside the camera for later.
52. Route the harness over the top of the LH impact assembly towards the centreline of the vehicle.
53. Re-plug in the grille DRL harness, then re-fit the grille, cover and bonnet release handle to the vehicle in reverse order.

TOOLS REQUIRED

FASTENERS

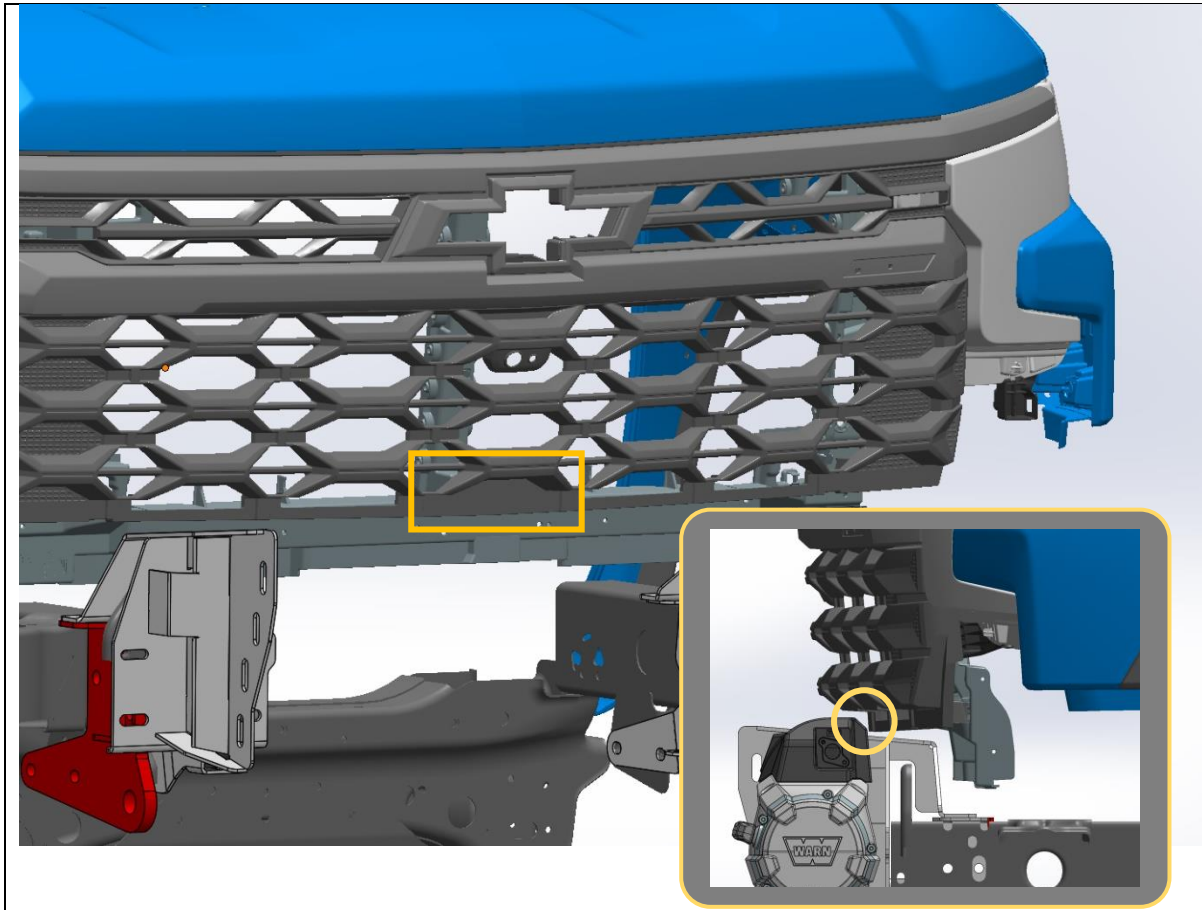

54. If fitting a WARN Zeon or a winch with a similar size, a small portion of the grille may need to cut to provide adequate clearance to the control box. It is best to do this before the bar is fully installed onto the vehicle.

TOOLS REQUIRED

FASTENERS



55. Pull and release the clips securing the plastic trim below the headlight. Discard this piece.

TOOLS REQUIRED

FASTENERS



56. Remove the bumper clip underneath the headlight by loosening 3x T15 Torx screws. Do not discard the fasteners.

TOOLS REQUIRED

T15 Torx Driver

FASTENERS

6x factory T15 Torx screw

Retain for Reassembly



57. Clean the top face of the supplied facelift infill bracket with isopropyl alcohol or similar cleaning solvent and let it dry.

58. Apply the supplied 3M Primer 94 adhesion promotor from the tape kit onto the same top face of the infill.

Important: allow at least 5 minutes for the primer to chemically bond to the surfaces before applying tape.

59. Apply 4x 100mm strips of supplied VHB tape in the arrangement shown.

TOOLS REQUIRED

Isopropyl alcohol
Rag

FASTENERS

VHB Tape pads
Primer 94



- 60. Clean the underside face of the headlight with isopropyl alcohol or similar cleaning solvent and let it dry.
- 61. Fit 2x M6 cage nuts into the headlight infill support bracket. Use a flat head screwdriver to assist.
- 62. Fit the headlight infill support bracket to the underside of the headlight using 2x factory retained T15 Torx screws and 2x M5 flat washers.
- 63. Repeat for other side.

TOOLS REQUIRED

- Isopropyl alcohol
- Rag
- Flat head screwdriver
- T15 Torx driver

FASTENERS

- 4x factory T15 Torx screw
- 4x M5 flat washer



- 64. Remove backing film of VHB tape and present infill up against the bottom face of the headlight.
- 65. Align the infill so it is central and in line with the front face of the headlight.
- 66. Apply even pressure for 20-30 seconds to ensure best adhesion of the tape to the headlight.
- 67. Secure the infill to the support bracket with 2x M6x16 black button head bolts and 2x black flat washers.
- 68. Repeat for other side.

TOOLS REQUIRED

4mm hex/Allen key

FASTENERS

4x M6x16 black button head
4x M6 black washer
4x M6 cage nut

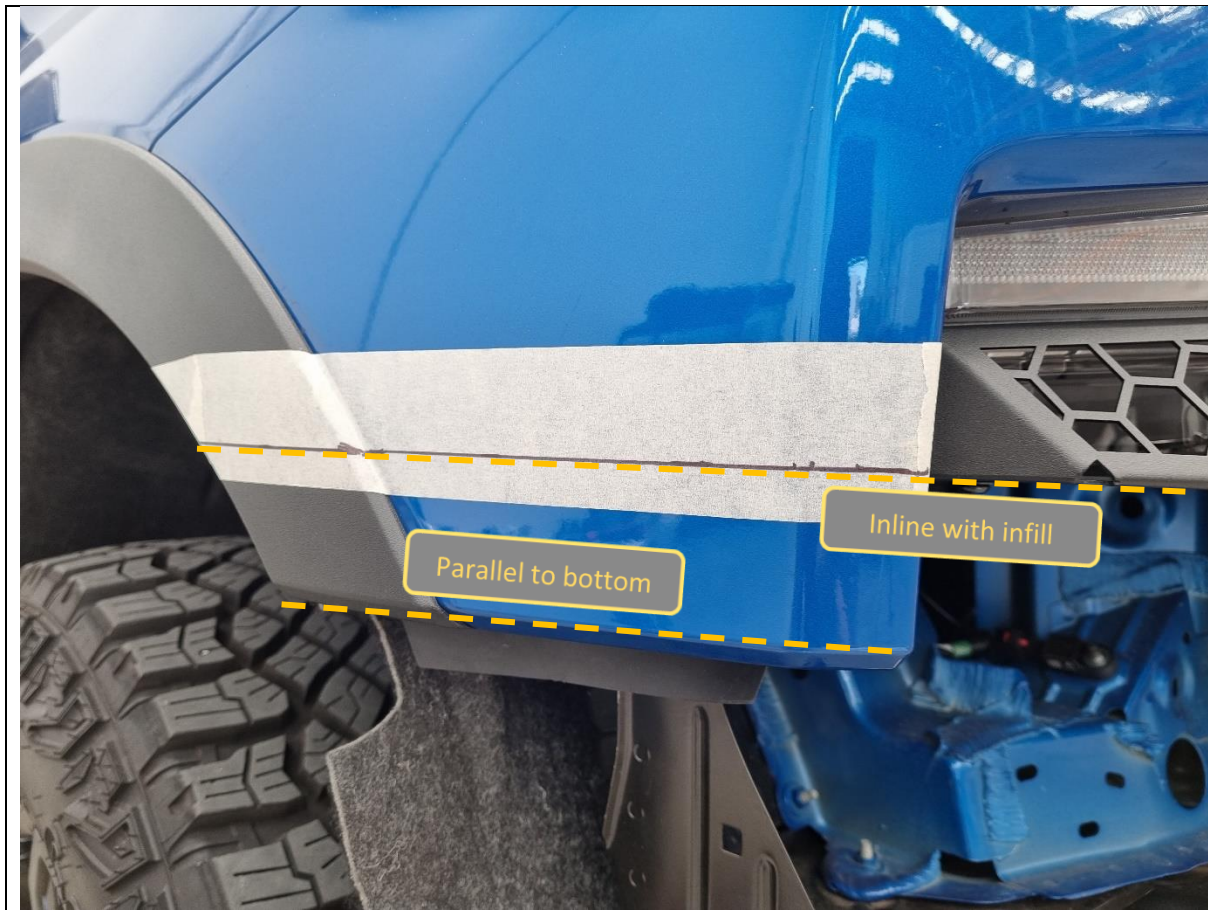

- 69. The bumper winglets need to be cut for fitment of the bar. Apply masking over the area shown to protect the plastic.
- 70. Next mark out a horizontal line parallel to the bottom of the winglet, and in line with the bottom edge of the headlight infill.

TOOLS REQUIRED

- Masking tape
- Marker pen

FASTENERS



71. Using an air hacksaw or similar cutting device, perform a clean cut along the marked line in the bumper winglet. Take extra care not to cut/damage the headlight, infill or wheel arch liner.
72. Use a utility knife or similar to clean up the inside of the winglet, so that it is a flat surface. Anything that clips the winglet into the headlight needs to be cut off.

TOOLS REQUIRED

Air hacksaw or similar

Utility knife

FASTENERS



73. Using a 10mm socket, remove all the bolts securing the wheel guard bracket to the vehicle and headlight. Retain these fasteners for re-use.

TOOLS REQUIRED

10mm socket

FASTENERS

10mm hex bolts

Retain for Reassembly



74. Clean the outer face of the bumper winglet support with isopropyl alcohol or similar cleaning solvent and let it dry.

75. Apply the supplied 3M Primer 94 adhesion promotor from the tape kit onto the same outer face.

Important: allow at least 5 minutes for the primer to chemically bond to the surfaces before applying tape.

76. Apply 2x 100mm strips of supplied VHB tape in the arrangement shown (bottom left).

77. Fit the bumper winglet support to the supplied headlight bracket and loosely secure with 2x M6x12 hex bolts, flat washers and flange nuts.

78. Repeat for other side.

TOOLS REQUIRED

FASTENERS

- 4x M6x12 hex bolt
- 4x M6 flat washer
- 4x M6 flange nut

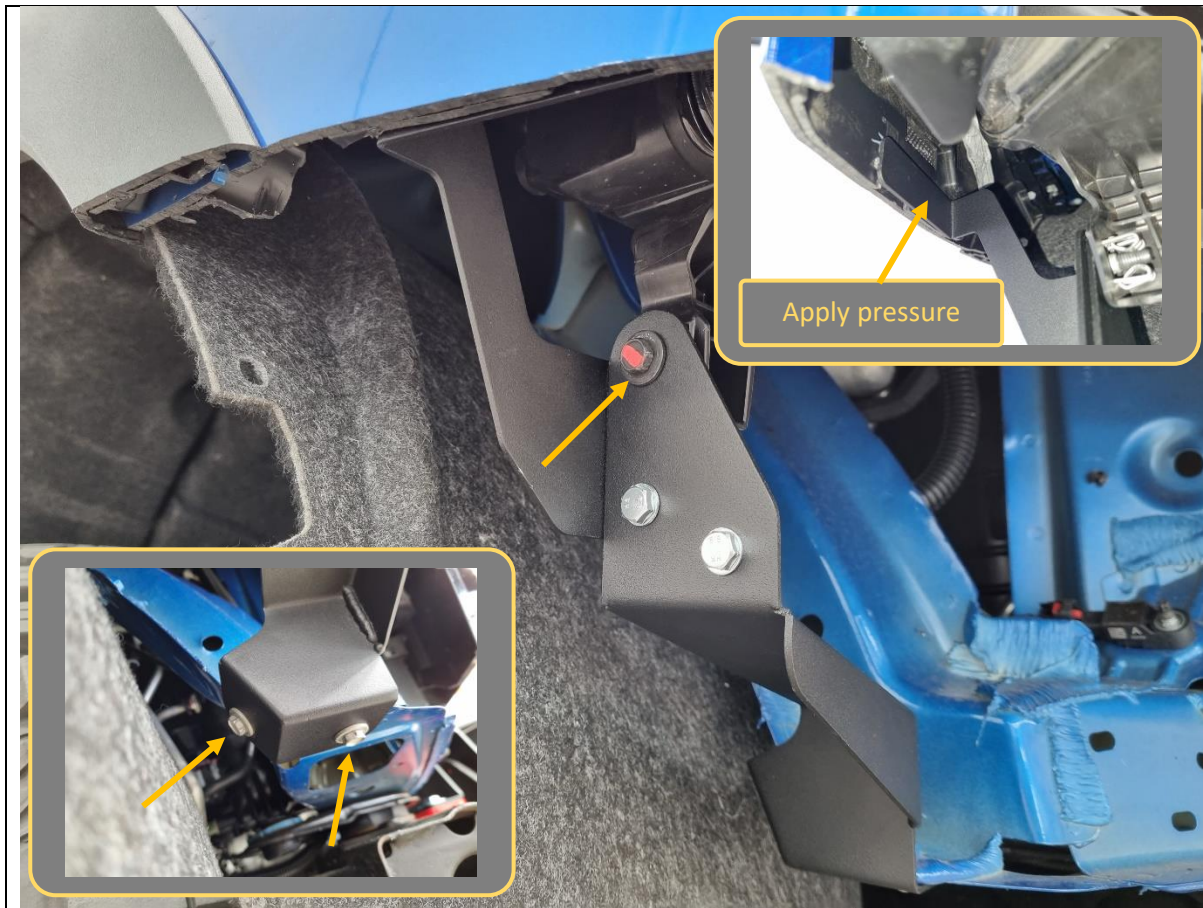

- 79. Remove backing film of VHB tape and present bumper winglet support and headlight bracket up to the vehicle.
- 80. Align the tape face to the inside of the cut bumper winglet, then secure the brackets to the headlight with 1x 10mm hex bolt (from Step 73)
- 81. Fit the bottom of the headlight bracket to the body with 2x 10mm hex bolts (also from Step 73).
- 82. Apply even pressure for 20-30 seconds on the bumper winglet to ensure proper adhesion to the support bracket.
- 83. Repeat for other side of vehicle.

TOOLS REQUIRED

10mm socket

FASTENERS

6x factory 10mm hex bolts

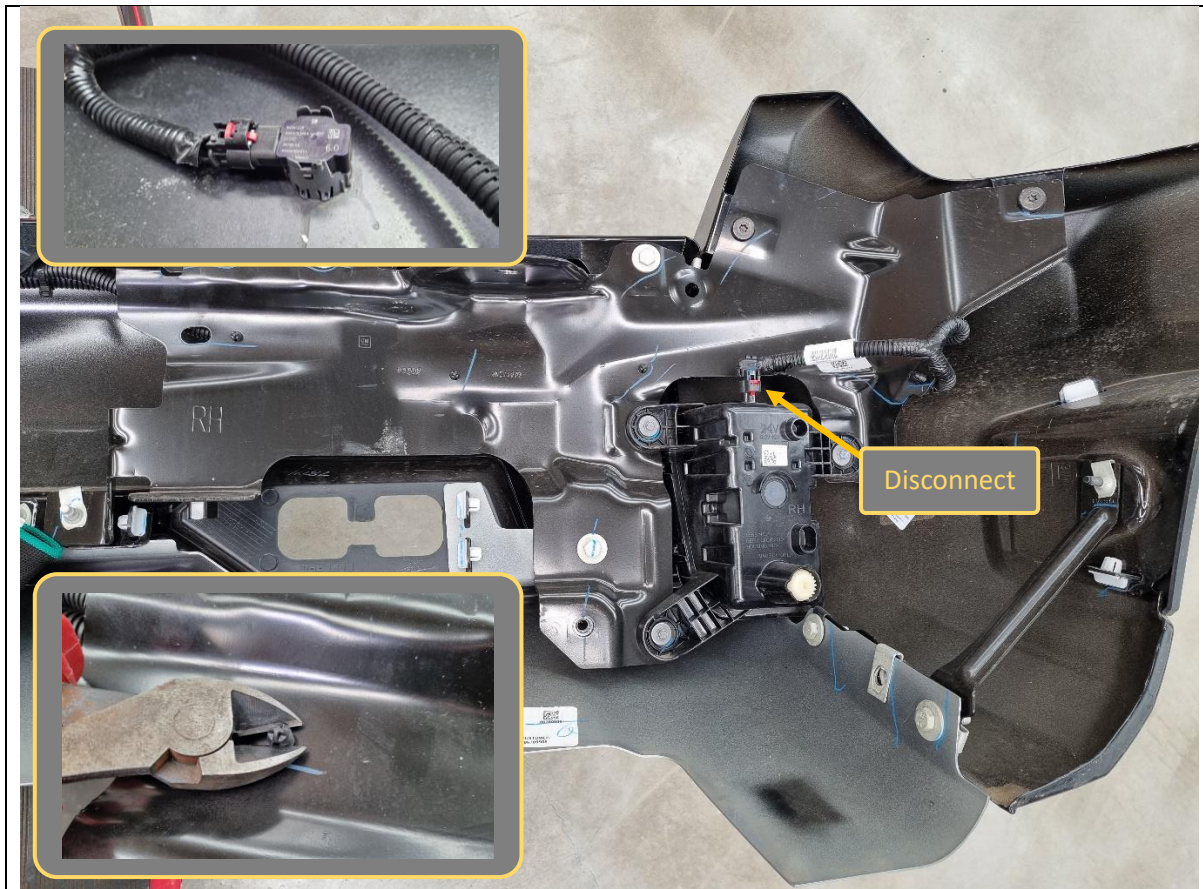

<p>84. Prepare the bumper for stripping parts.</p> <p>85. Remove the number plate and set aside.</p> <p>86. If fitting fog lights, disconnect the plug on the back of the fog light.</p> <p>87. If equipped, unclip the 4x parking sensors from their plastic holders. The holders will not be re-used.</p>	<p>TOOLS REQUIRED</p> <p>Side cutters</p> <p>Trim tool</p>
<p>Note down the orientation of the parking sensors before fully removing.</p> <p>88. Pry off or cut off the clips holding the wiring harness in the bumper (see inset), then separate the harness from the bumper.</p>	<p>FASTENERS</p>



- 89. Prepare the bar for fitment. Start by routing wiring harness through the bar such that all plugs are in the correct location. Secure loom with cable ties to the bar.
- 90. If the option has been selected, fit the Offroad Animal Halo fog lights to the supplied fog light brackets using 4x M4x12 pan head screws, flat washers and flange nuts (each).

TOOLS REQUIRED

Phillips head screwdriver

Cable ties

FASTENERS

8x M4x12 pan head

8x M4 flat washer

8x M4 flange nut

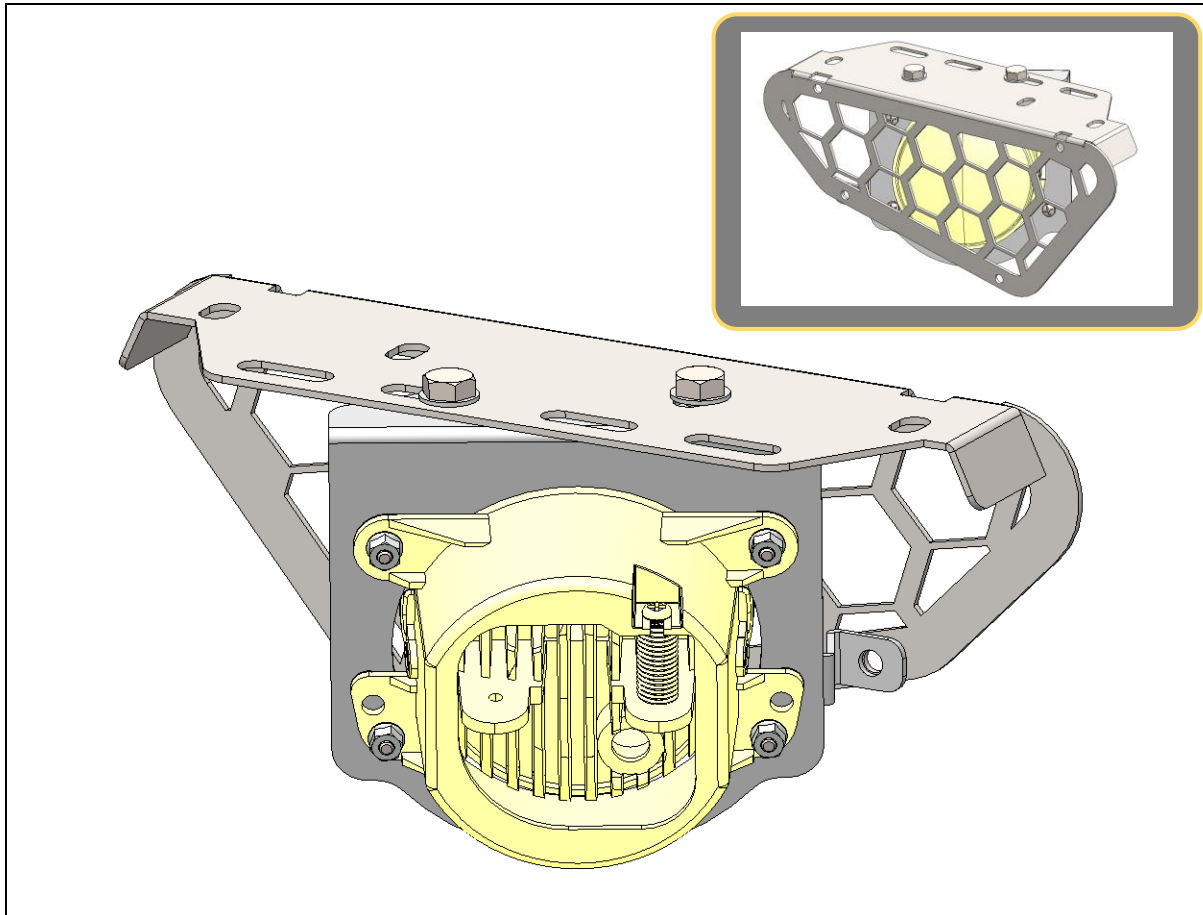

91. Fit the fog light and bracket to the mesh panel, using the supplied 2x M8x12 hex bolts, flat washers and flange nuts.

Match the orientation as shown.

92. Repeat for other fog light.

TOOLS REQUIRED

13mm socket

FASTENERS

4x M8x12 hex bolt
4x M8 flat washer
4x M8 flange nut



- 93. Fit the fog light + mesh panel to the bulbar using 4x M16x16 black button head bolts, black flat washers and flange nuts.
- 94. Secure and tighten using 4mm hex/Allen key and repeat for other side.
- 95. Re-wire the fog light and connect to the bumper loom.

TOOLS REQUIRED

4mm hex/Allen key

FASTENERS

8x M6x16 black button head
8x M6 black washer
8x M6 flange nut

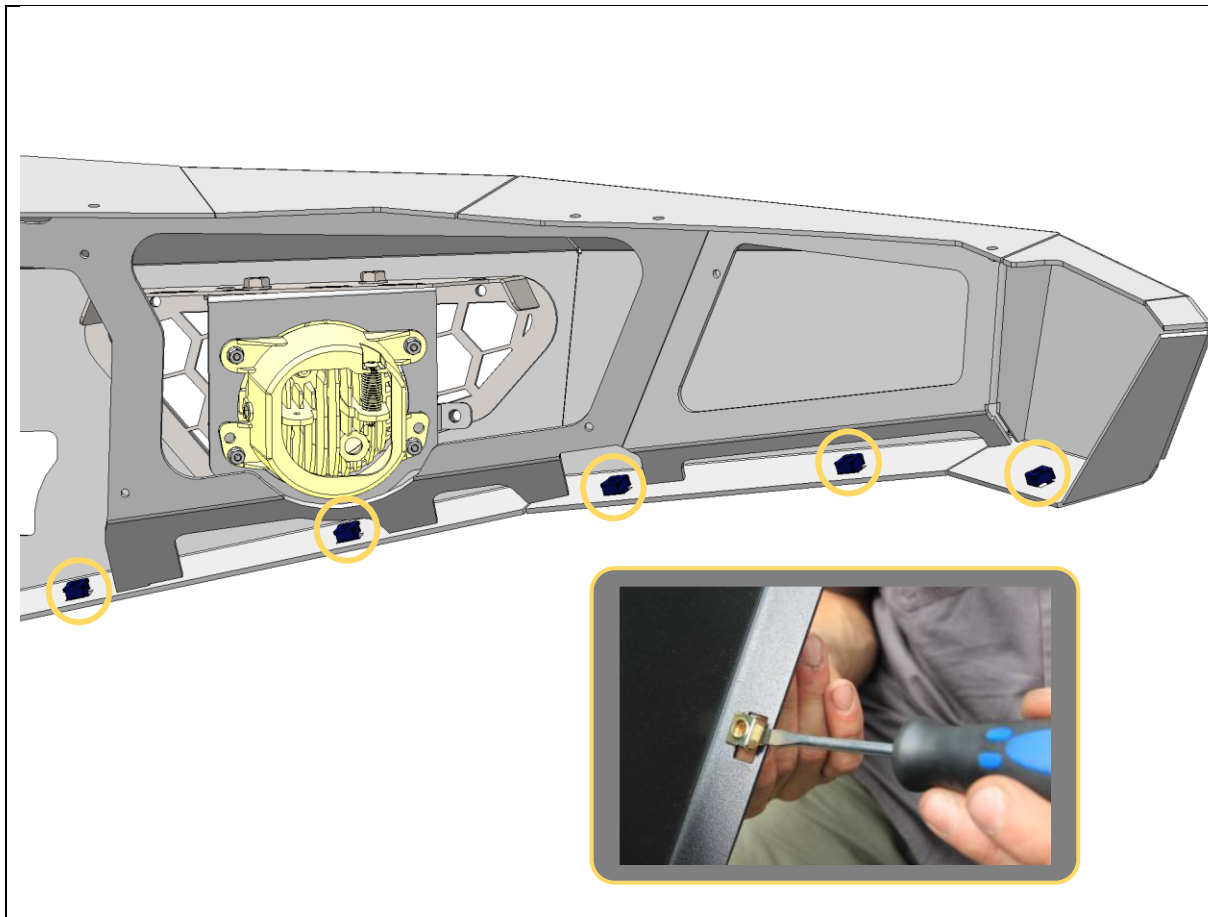

96. Fit 5x M6 cage nuts into the rectangular slots on the bottom of the bar wing.
- To aid fitting, use a small flat blade screwdriver to push the edge of the cage nut to engage with the slot.
97. Repeat for other side of the bar.

TOOLS REQUIRED

Flat blade screwdriver

FASTENERS

10x M6 cage nut



<p>98. If fitting an integrated light bar, do so now.</p> <p>This bar is designed to fit the Offroad Animal 22-inch light bar. If fitting this light bar, assemble the light bar with legs facing outwards, and line it up with the slots in the centre gusset. Secure with M6 fasteners supplied with the light.</p>	<p>TOOLS REQUIRED</p> <p>4mm hex/Allen key 10mm spanner</p> <p>Supplied with light bar</p>
<p>This bar can accommodate most other “20-22inch” size light bars.</p> <p>99. If fitting driving lights or top hoop to this bar, this is also the most convenient time to do so. It is still possible later but is more difficult.</p> <p>100. Fit the pan brace to the back of the bar using 5x M6x16 black button head bolts, flat washers and flange nuts.</p>	<p>FASTENERS</p> <p>5x M6x16 black button head 5x M6 black flat washer 5x M6 flange nut</p> <p>Supplied with light bar</p>

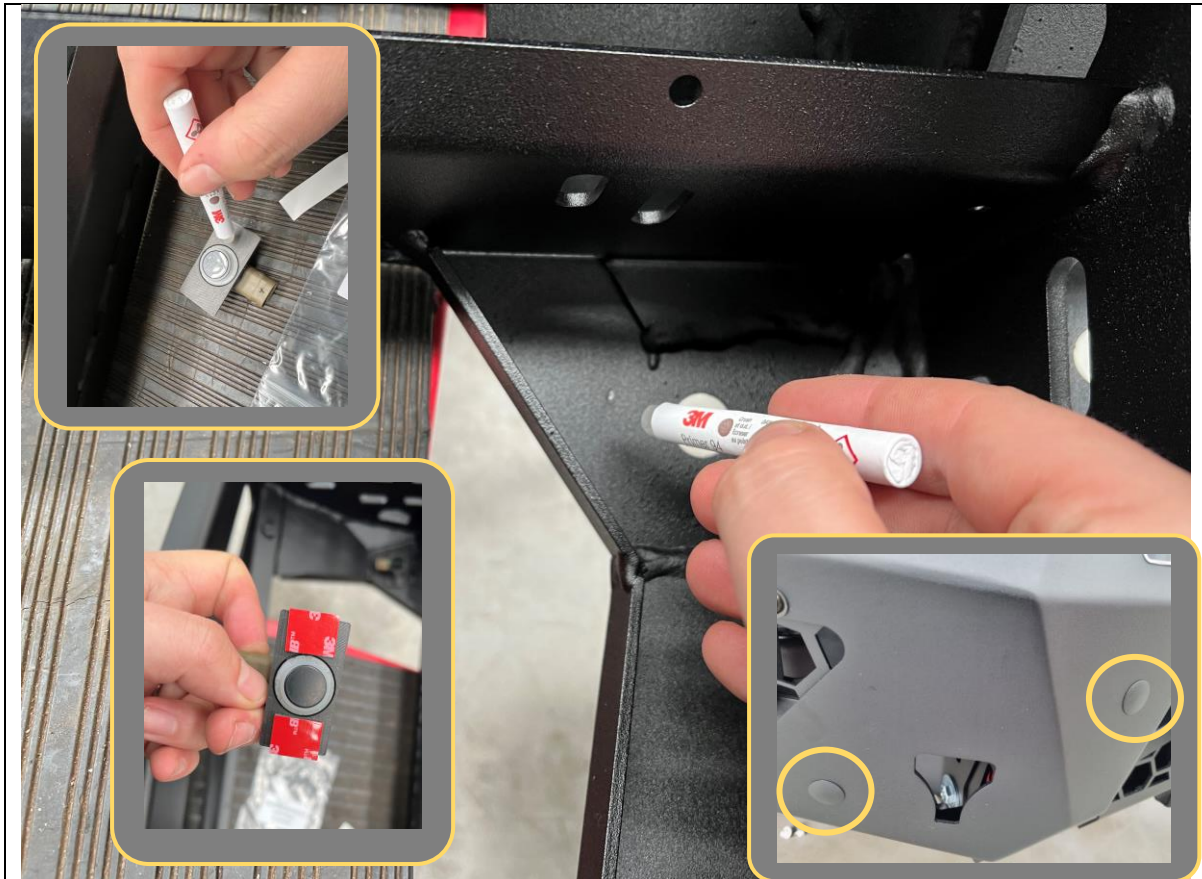

101. If not fitting parking sensors, insert the 4x supplied round plastic blanking plugs into the holes of the bar.
102. Otherwise, clean area surrounding the parking sensor holes in the bar with isopropyl alcohol or similar cleaning solvent and let it dry.
103. Lightly scuff the bonding surfaces of the 4x supplied plastic sensor housings with sandpaper. Then clean with isopropyl alcohol or similar.
104. Apply the 3M Primer 94 adhesion promotor from the tape kit to the parking sensor locations, on both the bar and the sensor housings.
Important: allow at least 5 minutes for the primer to chemically bond to the surfaces before applying tape.
105. Apply supplied VHB tape pads to all sensor housings as shown in the inset photo.
106. Dry fit sensors to bar to check loom position is correct.
107. Remove backing and adhere sensors in position in bar. Apply pressure for 20-30sec after positioning for best adhesion.
108. Add a pea-sized blob of automotive adhesive sealant over the sensor holder and inside face of bar to hold to ensure the tape holds position.
109. Connect all parking sensor loom connectors.

TOOLS REQUIRED

Isopropyl alcohol
Rag
Automotive adhesive sealant (eg. Sikaflex)

FASTENERS

4x plastic blanking plugs

or

VHB Tape pads
Primer 94



110. Fit the supplied pinch weld to both ends of the bar wing as shown.

TOOLS REQUIRED

FASTENERS

Bulb pinch weld



- 111. With assistance, either from another person, or a lifting trolley, lift the bar onto the mounts on the vehicle.
- 112. Reconnect the bumper wiring harness to the vehicle.
- 113. Secure with 8x M12x30 Bolts, heavy duty washers and M12 Nyloc + flange nuts. Leave finger tight at this stage.

Note: Use a washer on both bolt and nut side for the Nyloc nut. 1x washer on the bolt side is all that is required with flange nuts.

TOOLS REQUIRED

Lifting trolley

FASTENERS

8x M12x30 hex bolt
10x M12 heavy duty washer
2x M12 Nyloc nut
6x M12 flange nut

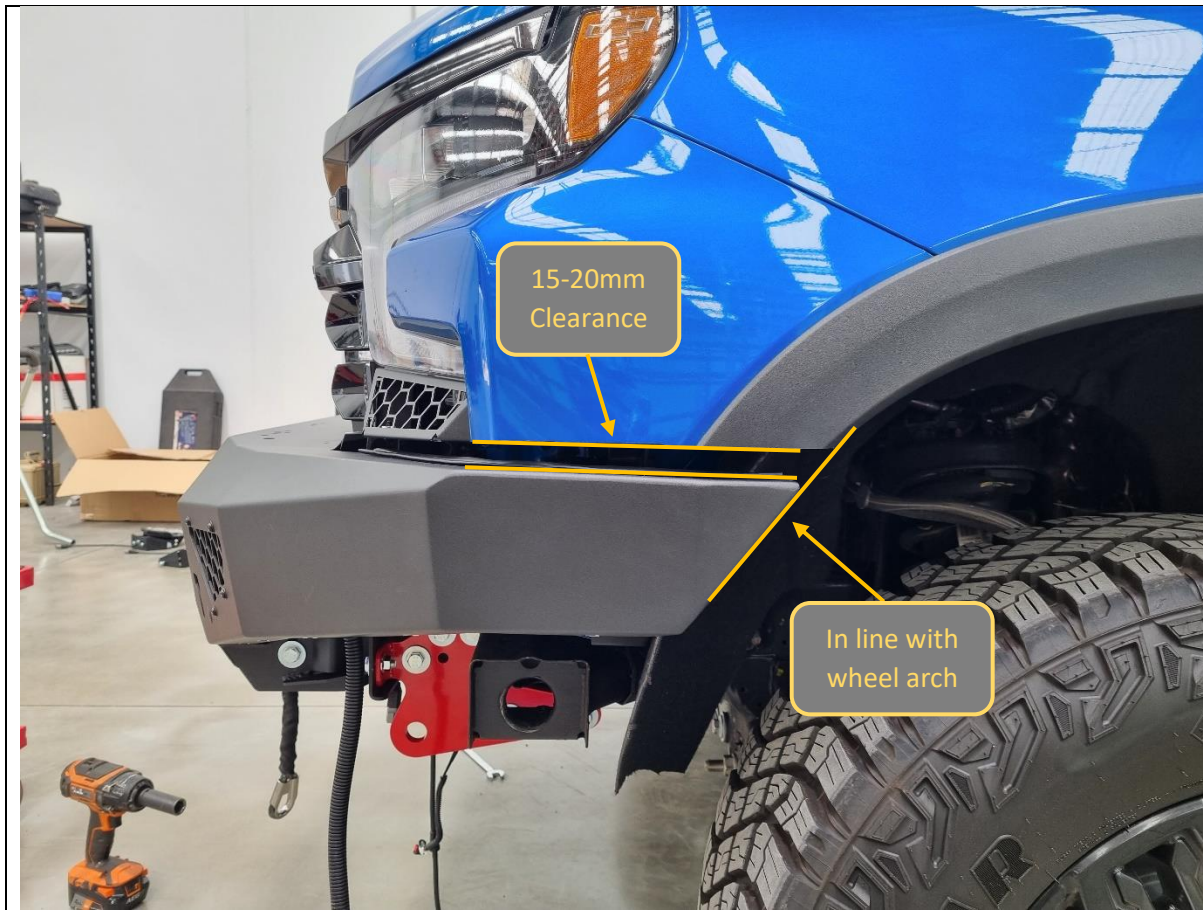

114. With assistance, from another person, align the bar with the edges of the vehicle. The bar should sit symmetric left/right on the vehicle.
- In front view, the top face of the bar should sit parallel with the ground, and have about 15-20mm vertical clearance to the bottom of the headlight infill.
- In side view, the end of the bar wing should be in line with the wheel arch liner.
115. Once happy with alignment, tighten all 8x M12 bolts.

TOOLS REQUIRED

- Lifting trolley
- 18/19mm socket

FASTENERS



<p>116. If fitting a winch, do so now.</p> <p>This bar is designed to fit most low mount winches, in foot down configuration. WARN ZEON 12 is the largest winch confirmed to fit (with grille cut, see Step 54 for explanation)</p>	<p>TOOLS REQUIRED</p> <p>Refer to instructions supplied by winch</p>
<p>117. The control box can be mounted on top of the winch, or to the side as shown. Winches usually come with a bracket to allow this. Refer to winch manufacturer.</p> <p>In some rare cases, the winch control box may need to be relocated elsewhere using custom bracketry.</p> <p>118. Ensure clutch handle will be accessible through opening in front mesh panel. Refer to winch instructions regarding changing clutch handle location.</p>	<p>FASTENERS</p> <p>Supplied with winch</p>



- 119. Loosen the M12 flange nut on the rearmost chassis mount hole installed in Step 35.
- 120. Install the tension strap connecting the winch cradle to the rearmost chassis mount hole, using 1x M10x25 hex bolt, flat washer and flange nut. Re-secure the rear with the M12 flange nut.
- 121. Repeat on other side for other tension strap.

TOOLS REQUIRED

- 16mm socket
- 18/19mm socket

FASTENERS

- 2x M10x25 hex bolt
- 2x M10 flat washer
- 2x M10 flange nut



<p>122. If required, fit the winch fairlead to the mesh fairlead mount using M10 or 3/8" fasteners supplied with the winch. This bar is only compatible with hawse type fairleads.</p> <p>123. Fit number plate flip mount to mesh panel using 2x M6x20 hex bolts, flat washers and flange nuts supplied in the number plate flip kit.</p>	<p>TOOLS REQUIRED</p> <p>10mm socket 13mm socket/spanner 4mm hex/Allen key Phillips head screwdriver</p>
<p>124. Attach number plate to mount using supplied pan head screws in the number plate flip kit.</p>	<p>FASTENERS</p> <p>2x M6x20 hex bolt 2x M6 flat washer 2x M6 flange nut</p>



- 125. If relocating the front camera, secure the entire camera and mounting bracket to the supplied facelift camera housing using 2x M5x15 black button bolts, black flat washers and flange nuts.
- 126. Attach the camera and housing to the mesh fairlead with 2x M5x15 black button head bolts and black flat washers.

TOOLS REQUIRED

3mm hex/Allen key

FASTENERS

4x M5x15 black button head
4x M5 black flat washer
2x M5 flange nut

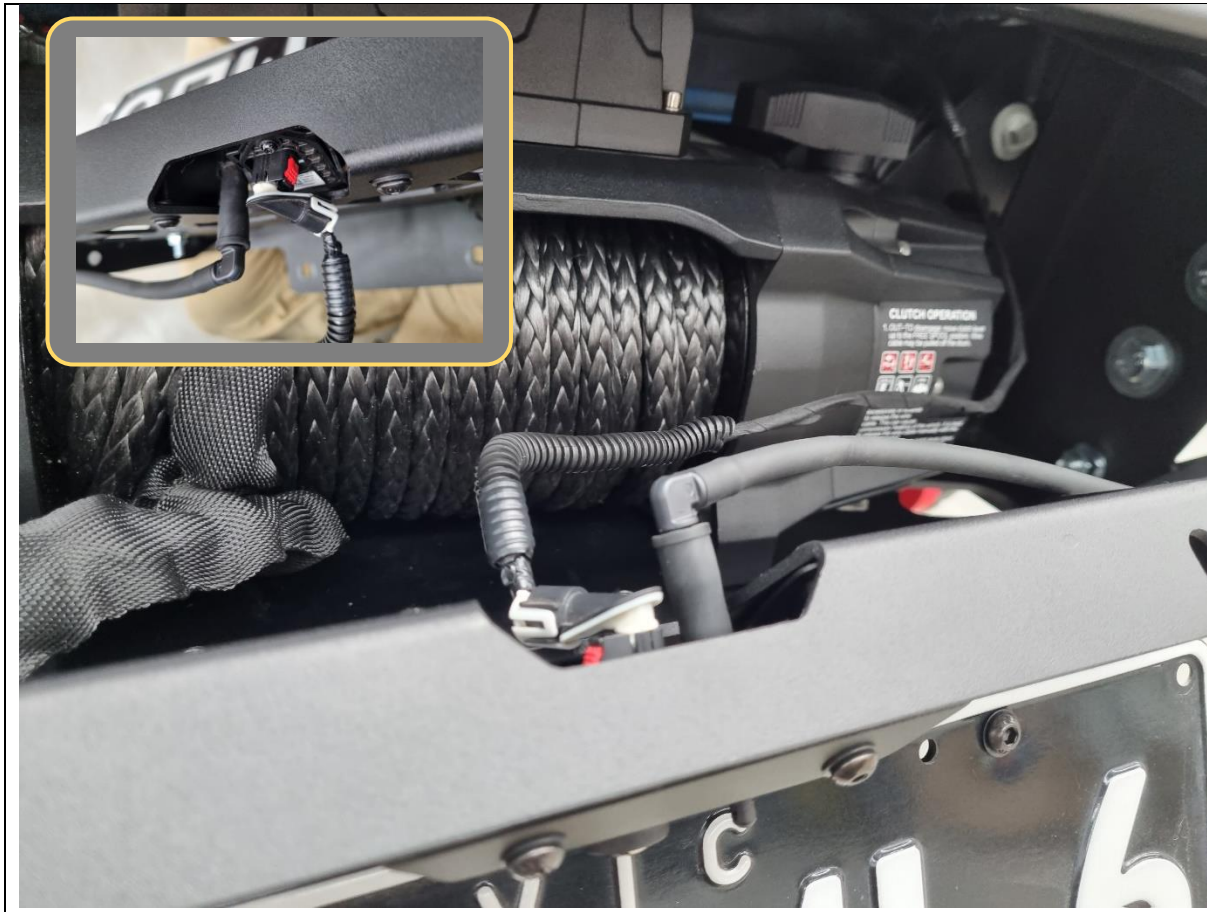

- 127. Hold the mesh fairlead up to the bar and connect the camera harness and washer hose to the back of the camera housing.

- 128. Feed winch cable through the hawse fairlead if applicable.

TOOLS REQUIRED

FASTENERS



- 129. Fit the mesh fairlead mount to the centre of the bar, using 2x M8x16 black button head bolts (top), 2x M8x20 hex head bolts (bottom) and 4x flat washers.
- 130. Tighten fasteners using 13mm socket/spanner and 5mm hex/Allen key.

TOOLS REQUIRED

13mm socket/spanner
5mm hex/Allen key

FASTENERS

2x M8x16 black button head
2x M8 black flat washer

2x M8x20 hex head
2x M8 flat washer



- 131. Fit the centre bash plate to the bar using 4x M8x20 black button bolts and flat washers.
- 132. Secure the back of the centre bash plate to the chassis mount bracket using 2x M10x25 hex bolts, flat washers and flange nuts (see inset).

TOOLS REQUIRED

- 5mm hex/Allen key
- 16mm socket/spanner

FASTENERS

- 4x M8x20 black button head
- 4x M8 black flat washer
- 2x M10x25 hex bolt
- 2x M10 flat washer
- 2x M10 flange nut

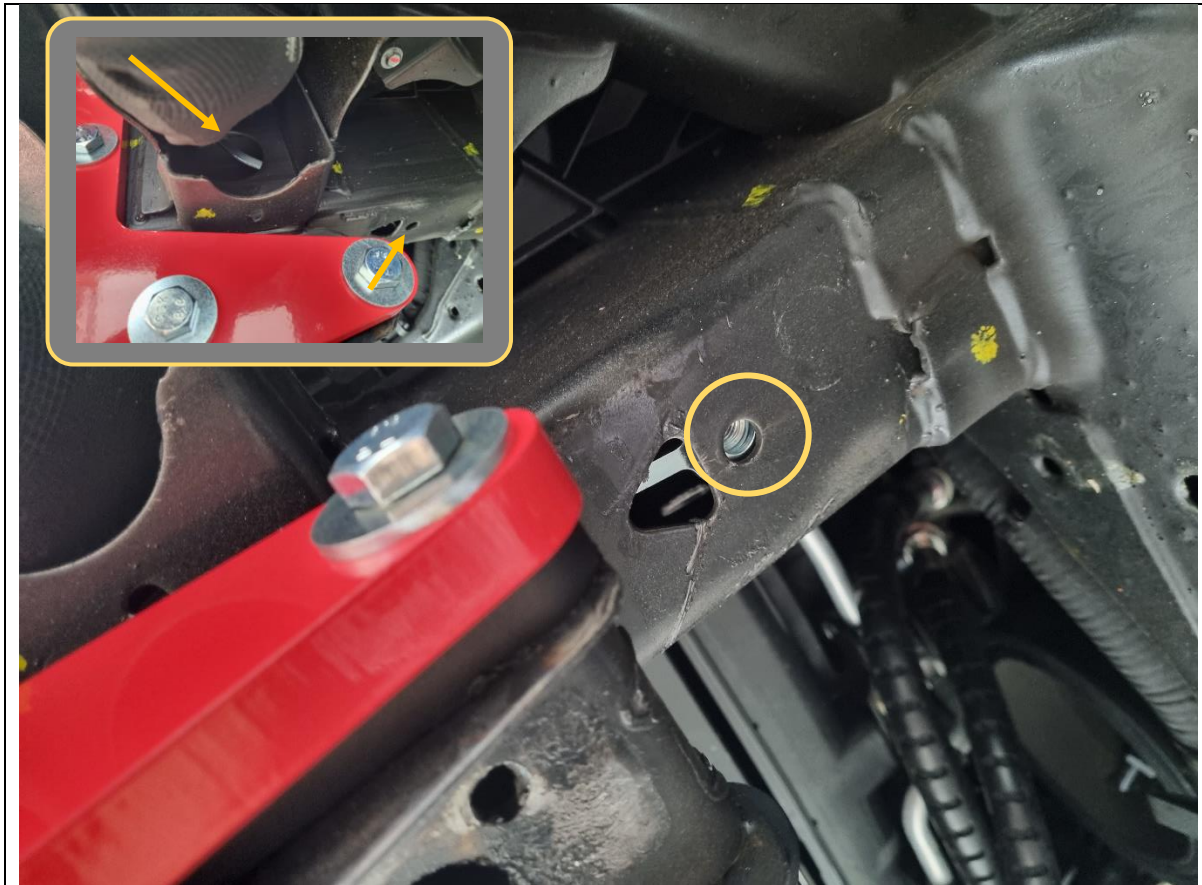

- 133. Insert 1x M8 lollipop nutplate through the opening in the chassis rail beneath the body mount bracket.
- 134. Align the nutplate with the hole on the underside of the chassis rail as shown.
- 135. Repeat for other side.

TOOLS REQUIRED

FASTENERS

2x M8 lollipop nutplate

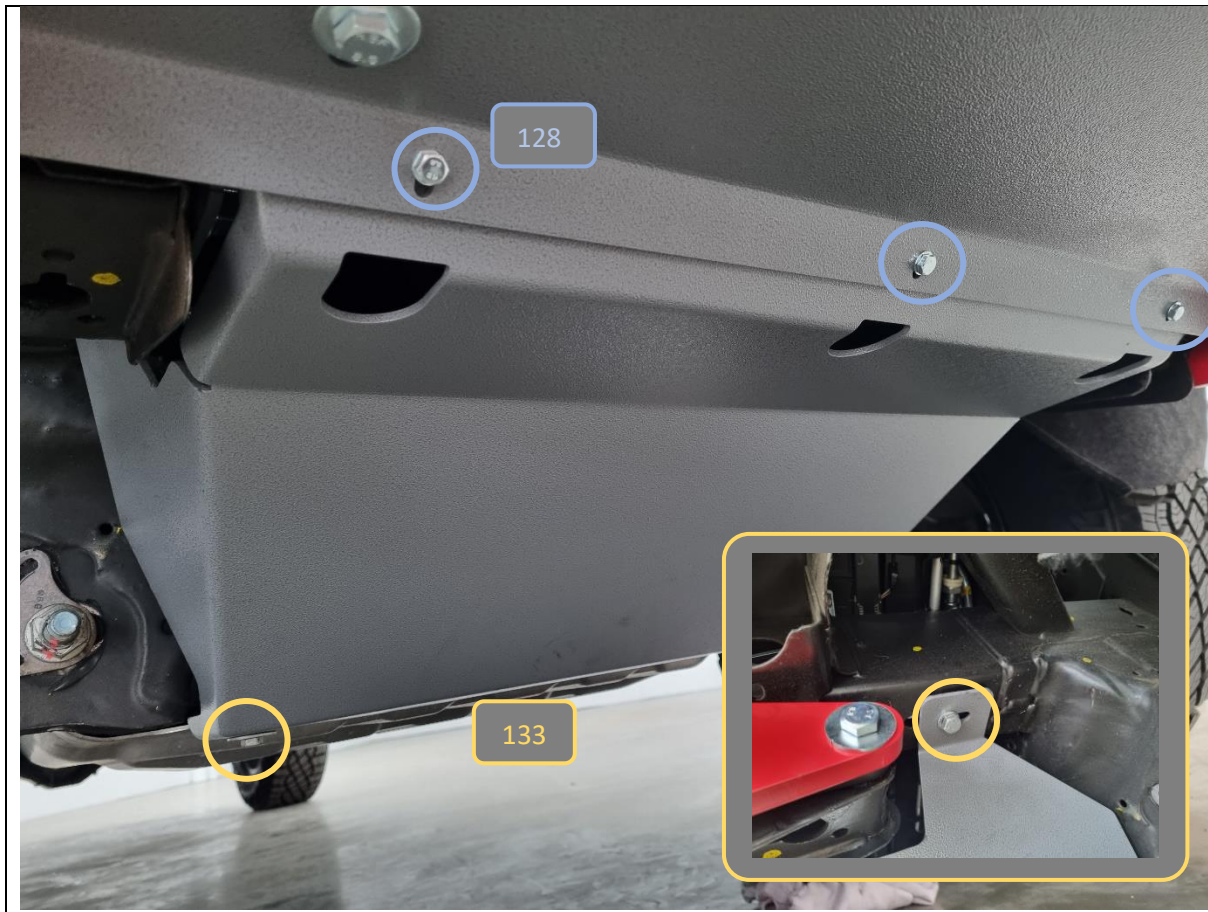

136. Fit the lower bash plate to the vehicle by re-using the 4x 13mm hex bolts from Step 12.

Fit the rear 2x bolts through the factory under shield.

Fit the front 2x bolts through the chassis rail into the previously installed nutplates.

137. Secure the front lip of the lower bash plate to the centre bash plate with 3x M6x20 hex bolts, flat washers and flange nuts. Insert flange nuts through the hole cutouts in the lower base plate.

TOOLS REQUIRED

10mm socket
13mm socket

FASTENERS

4x factory 13mm hex bolt

3x M6x20 hex bolt
3x M6 flat washer
3x M6 flange nut



- 138. Loosely fit the side underpanel mount bracket to the side underpanel with 1x M8x16 black button head bolt, black flat washer and flange nut (see bottom right). Leave finger tight at this stage.
- 139. Loosely fit the side underpanel to the bar with 5x M6x16 black button head bolts and black flat washers.
- 140. Loosely fit the side underpanel mount bracket to the chassis with 2x factory 15mm hex bolts retained from Step 26 (see bottom left).
- 141. Repeat for other side underpanel.

TOOLS REQUIRED

- 4mm hex/Allen key
- 5mm hex/Allen key
- 15mm socket

FASTENERS

- 4x factory 15mm hex bolt
- 10x M6x16 black button head
- 10x M6 black flat washer
- 2x M8x16 black button head
- 2x M8 black flat washer
- 2x M8 flange nut



<p>142. Using the edge of the side underpanel as a guide, mark the wheel arch liner, approximately 10mm below the side underpanel.</p> <p>143. Cut along the marked line with a utility knife.</p> <p>144. Tuck the wheel arch liner behind the flange of the side underpanel.</p>	<p>TOOLS REQUIRED</p> <p>Utility knife</p> <p>4mm hex/Allen key</p> <p>5mm hex/Allen key</p> <p>15mm socket</p>
<p>145. Tighten all side underpanel bolts and repeat for other side.</p>	<p>FASTENERS</p>



<p>146. Fit the Offroad Animal logo plate to the front of the vehicle as shown.</p> <p>147. Fit the compliance plate in a visible location on the underside of the bar. We recommend placing it on the bottom of the centre bash plate.</p>	<p>TOOLS REQUIRED</p> <p>5mm hex/Allen key</p>
<p>148. Toro only. If required, fit the supplied antenna mounting brackets to the back of the bar, and secure with 2x M8x20 black button head bolts and black washers, each.</p> <p>149. Toro only. Else fit the 2x M8x20 black button head bolts and black washers to the back of each bullbar upright, to protect nut threads in bar for future use.</p> <p>150. Review fitment and double check all bolts are tightened correctly.</p>	<p>FASTENERS</p> <p>4x M8x20 black button head 4x M8 flat washer</p>



Congratulations! You're done!
Head for the tracks and enjoy your newly protected ZR2!