



Ford Ranger / Everest Next Gen Predator & Toro Front Bar Fitting Instruction

IMPORTANT! – READ BEFORE INSTALLATION

- When installed in accordance with these instructions, the front protection bar does not affect the operation of the vehicles SRS airbags.
- This product must be installed exactly as per these instructions using only hardware supplied.
- Take a few moments to read instructions thoroughly before beginning work.
- In the event of damage to any bar component please contact OFFROAD ANIMAL to arrange repair/replacement of components.
- Do not use this product for any vehicle make or model other than that specified on these instructions.
- Do not remove labels from this product.
- This product and its fixings must not be modified in any way unless stated in these fitting instructions.
- The installation of this product is recommended for trained personnel.
- These instructions are correct at time of publication. OFFROAD ANIMAL cannot be held responsible for the impact of any changes subsequently made by the vehicle manufacturer. If you find something has changed please contact us to let us know!
- During installation it is the duty of the installer to check correct operation/clearances of all components.
- If Instructions are to be printed for reference in the workshop, it is recommended that they are printed in colour, for best legibility.

PARTS LISTING

IMPORTANT: Check all parts are present before beginning work! Contact OFFROAD ANIMAL if something is missing.

Main Parts – In the Box

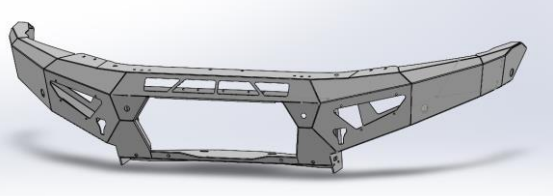
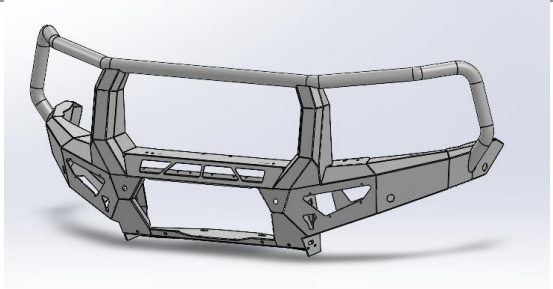
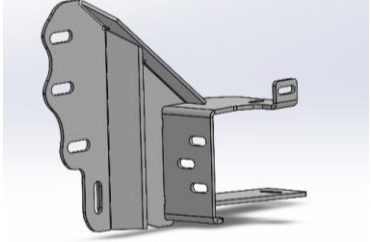
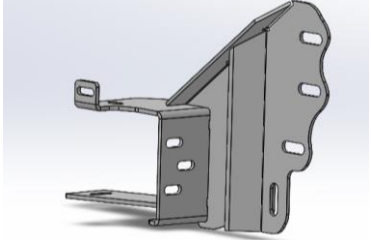
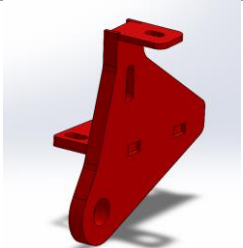
Qty	Part Number	Description	Image
1	FB-FRA-NG-22-PR-ASM1	Ford Next Gen Ranger Predator Bar Weldment	
Or			
1	FB-FRA-NG-22-TOR-ASM1	Ford Next Gen Ranger Predator Bar Weldment	
1	FB-FRA-NG-22-PR-ASM2L	Next Gen Ranger Impact Assy	
1	FB-FRA-NG-22-PR-ASM2R	Next Gen Ranger Impact Assy	
1	FB-FRA-NG-22-PR-ASM3L	Next Gen Ranger Tow Point Assy	



1	FB-FRA-NG-22-PR-ASM3R	Next Gen Ranger Tow Point Assy	
1	FB-FRA-NG-22-PR-ASM4	Next Gen Ranger Fairlead Mesh Assy	
1	B-0787L	Ranger Predator Intercooler / Bash Plate Tie Bracket	
1	B-0787R	Ranger Predator Intercooler / Bash Plate Tie Bracket	
1	B-0781L	Next Gen Ranger Predator Intercooler Support Bracket	
1	B-0781R	Next Gen Ranger Predator Intercooler Support Bracket	
1	M-0002L	Light Cover Mesh	
Or			
1	M-0030L	Wing Mesh Panel - Toro With Indicator Repeater	



1	M-0002R	Light Cover Mesh	
Or			
1	M-0030R	Wing Mesh Panel - Toro With Indicator Repeater	
1	B-0772L	Ford Ranger Next Gen 4 bolt Fog Light Bracket	
1	B-0772R	Ford Ranger Next Gen 4 bolt Fog Light Bracket	
1	B-0804L	Ford Ranger Next Gen Fog Light Bracket - Small 3 Bolt	
1	B-0804R	Ford Ranger Next Gen Fog Light Bracket - Small 3 Bolt	
1	U-0056	Next Gen Ranger Bash Plate	
1	U-0058L	Next Gen Ranger Side Under panel	
1	U-0058R	Next Gen Ranger Side Under panel	





1	B-0788L	Next Gen Ranger Inside Metal Infill Pane	
1	B-0788R	Next Gen Ranger Inside Metal Infill Pane	
1	B-0780	Next Gen Ranger Predator Pan Brace	
1	P-0244	Ford Ranger Next Gen Radar Mount Plate	
1	B-0782	Ford Ranger Next Gen Predator - Number Plate Bracket	
2	P-0256	Ford Ranger Next Gen Infill Bolt plate	
1	B-0789	Next Gen Ranger Grille Support Bracket	
1	B-0837	Ford Everest U704 Grille Support Bracket	
1	N-0004	Ford Ranger P703 Radar Cover Panel	
2	F-0010	Ford Ranger Next Gen Sensor Holder - Straight	
2	F-0011	Ford Ranger Next Gen Sensor Holder - 11 Deg Horizontal	
2	F-0012	Ford Ranger Next Gen Sensor Holder - 15 Deg Horizontal	

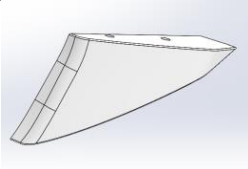
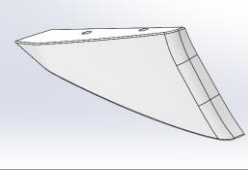
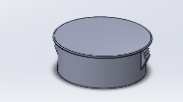
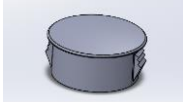
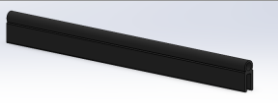

1	F-0008L	Next Gen Ranger Outside Plastic Infill Panel	
1	F-0008R	Next Gen Ranger Outside Plastic Infill Panel	
4	CPHP020	Plasitc Hole Insert, 28MM, Black, Tigerlink Hardware CPHP020	
2	CPHP029	Plasitc Hole Insert, 17.4MM, Black, Tigerlink Hardware CPHP029	
2	PWS-TOP-280	Pinch Weld PWS51T - Top Bulb Seal 280mm	
1	TK-COM-PSEN-6	Tape Kit - 6 Sensor Universal	No image
1	TK-FB-FRA-NG-22	Tape Kit - Next Gen Ranger Front Bar	No image

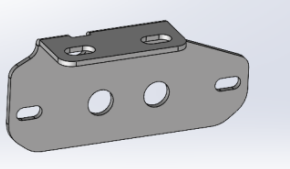
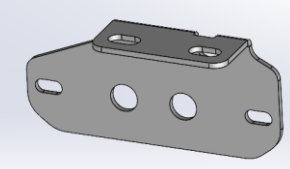
Toro ONLY Parts – In the Box

Qty	Part Number	Description	Image
1	B-0797L	Toro Indicator Repeater Bracket	
1	B-0797R	Toro Indicator Repeater Bracket	
1	11CAT1M-2	LED Autolamps 11CAT1M-2 Front Indicator - Twin Blister Pack	
Optional Extras			
2	LM-FRA-NG-IND	Indicator Wiring Harness – Next Gen Ranger (If Optioned)	



Predator Small Parts – Contained in Small Parts Kit Bag

QTY.	PART NO.	DESCRIPTION
35	M6 FLANGE NUT	Flange Nut, M6x1 G8.8 ZP
47	M6 FLAT WASHER BLACK ZINC	M6 Flat Washer, 12x6.1x1, ISO4042 ZnNi BLACK PASSIVATED FINISH
38	M6x16 BHCS BLACK ZINC	SCREW, BUTTON HEAD CAP, M6X16X1 GR12.9, ISO4042 ZnNi BLACK PASSIVATED FINISH
4	M6x12 BHCS	SCREW, BUTTON HEAD CAP, M6X12X1 GR12.9 ZP
10	M6CN3MM	CAGE NUT M6x2.6-3.5
3	M6x30 BHCS BLACK ZINC	SCREW, BUTTON HEAD CAP, M6X30X1 GR12.9, ISO4042 ZnNi BLACK PASSIVATED FINISH
4	M8 X 20 BHCS BLACK ZINC	SCREW, BUTTON HEAD CAP, M8X20X1.25, ISO4042 ZnNi BLACK PASSIVATED FINISH
10	M8 FLAT WASHER- BLACK ZINC	M8 FLAT WASHER, 16.5x8.4x1.2, ISO4042 ZnNi BLACK PASSIVATED FINISH
2	M8 X 16 BHCS BZP	SCREW, BUTTON HEAD CAP, M8X16X1.25 GR12.9, ISO4042 ZnNi BLACK PASSIVATED FINISH
8	M8 X 20 HEX	Bolt Hex, M8X20x1.25, GR8.8 ZP
14	M8 HD FLAT WASHER	M8 FLAT WASHER - High Tensile 19x8x1.9mm
16	M8 FLANGE NUT	Flange Nut, M8x1.25 G8.8 ZP
4	M8 FLAT WASHER	M8 FW
2	M8 NYLOC	NYLOC SELF LOCKING NUT, ST STL A2 ISO
2	M8 NYW	Washer, M8, Nylon
8	M8 X 25 HEX	Bolt Hex, M8X25x1.25, GR8.8 ZP
4	M8 X 12 HEX	Bolt Hex, M8X12x1.25, GR8.8 ZP
2	M10 x 25	Bolt Hex, M10X25x[1.5], GR8.8 ZP
2	M10X25 BHCS	SCREW, BUTTON HEAD CAP, M10X25X1.5 GR12.9 ZP
6	M10 FLANGE NUT	Flange Nut, M10x1.5 G8.8 ZP
6	M10 FW LHD	WASHER, FLAT M10X28.5X2.5
2	M10 X 45	Bolt Hex, M10X45X1.5, GR8.8 ZP
2	NP-COM-M10-190- ASM0	M10 LOLLYPOP NUT PLATE 190MM LONG
10	M12 FLANGE NUT	Flange Nut, M12x1.75 G8.8 ZP
8	M12 FW LHD	M12 FW Large Heavy Duty
8	M12X30	Bolt Hex, M12X30x1.75, GR8.8 ZP
2	M12 Nyloc nut	M12 NYLOC NUT



Toro Small Parts – Contained in Small Parts Kit Bag

QTY.	PART NO.	DESCRIPTION
38	M6 FLANGE NUT	Flange Nut, M6x1 G8.8 ZP
51	M6 FLAT WASHER BLACK ZINC	M6 Flat Washer, 12x6.1x1, ISO4042 ZnNi BLACK PASSIVATED FINISH
42	M6x16 BHCS BLACK ZINC	SCREW, BUTTON HEAD CAP, M6X16X1 GR12.9, ISO4042 ZnNi BLACK PASSIVATED FINISH
4	M6x12 BHCS	SCREW, BUTTON HEAD CAP, M6X12X1 GR12.9 ZP
12	M6CN3MM	CAGE NUT M6x2.6-3.5
3	M6x30 BHCS BLACK ZINC	SCREW, BUTTON HEAD CAP, M6X30X1 GR12.9, ISO4042 ZnNi BLACK PASSIVATED FINISH
8	M8 X 20 BHCS BLACK ZINC	SCREW, BUTTON HEAD CAP, M8X20X1.25, ISO4042 ZnNi BLACK PASSIVATED FINISH
14	M8 FLAT WASHER- BLACK ZINC	M8 FLAT WASHER, 16.5x8.4x1.2, ISO4042 ZnNi BLACK PASSIVATED FINISH
2	M8 X 16 BHCS BZP	SCREW, BUTTON HEAD CAP, M8X16X1.25 GR12.9, ISO4042 ZnNi BLACK PASSIVATED FINISH
8	M8 X 20 HEX	Bolt Hex, M8X20x1.25, GR8.8 ZP
14	M8 HD FLAT WASHER	M8 FLAT WASHER - High Tensile 19x8x1.9mm
16	M8 FLANGE NUT	Flange Nut, M8x1.25 G8.8 ZP
4	M8 FLAT WASHER	M8 FW
2	M8 NYLOC	NYLOC SELF LOCKING NUT, ST STL A2 ISO
2	M8 NYW	Washer, M8, Nylon
8	M8 X 25 HEX	Bolt Hex, M8X25x1.25, GR8.8 ZP
4	M8 X 12 HEX	Bolt Hex, M8X12x1.25, GR8.8 ZP
2	M10 x 25	Bolt Hex, M10X25x[1.5], GR8.8 ZP
2	M10X25 BHCS	SCREW, BUTTON HEAD CAP, M10X25X1.5 GR12.9 ZP
6	M10 FLANGE NUT	Flange Nut, M10x1.5 G8.8 ZP
6	M10 FW LHD	WASHER, FLAT M10X28.5X2.5
2	M10 X 45	Bolt Hex, M10X45X1.5, GR8.8 ZP
2	NP-COM-M10-190- ASM0	M10 LOLLYPOP NUT PLATE 190MM LONG
10	M12 FLANGE NUT	Flange Nut, M12x1.75 G8.8 ZP
8	M12 FW LHD	M12 FW Large Heavy Duty
8	M12X30	Bolt Hex, M12X30x1.75, GR8.8 ZP
2	M12 Nyloc nut	M12 NYLOC NUT



TOOLS REQUIRED

The following tools will be required to install the product.

Hand Tools	Power Tools	Workshop Supplies
Metric Socket Set 8-19mm Socket Extension Bar Metric Spanner Set 10-19mm Hex (Allen) Key Set 4-6mm Torx Key Set Trim Puller Tool Flat Blade Screwdriver set Phillips Head Screwdriver set Utility Knife Side Cutters Pliers Wire Strippers (Toro Only) Crimping Tool (Toro Only)	Electric/Air Impact Driver (Optional) Air Hacksaw Or Oscillating Multi Tool Or Angle Grinder	Panel Stand or Soft Blanket Cable Ties Masking Tape Black Automotive paint Scotch Brite or Fine Sandpaper Crimp terminals (Toro Only)

WORKSHOP SAFETY

It is the responsibility of the installer to always complete works in a safe manner. Make sure the following safety equipment is available and precautions are observed whilst fitting this product.

<p>Hearing Protection</p> 	<p>Always wear ear protection when using power tools.</p>
<p>Eye Protection</p> 	<p>Ensure eye protection is always worn when cutting or drilling.</p>
<p>Manual Handling</p> 	<p>Do not attempt to lift bar assemblies or rock sliders on your own.</p> <p>Always use two people to lift or use mechanical Lifting aid such as hydraulic lifting trolley.</p>
<p>Vehicle Support</p> 	<p>Always ensure vehicle is properly supported when working on it. Do not attempt to fit products whilst suspension work is being carried out. Do not work under a vehicle supported only by a jack.</p>



1. **If Relocating Front Camera – Read and understand camera relocation bracket instructions before beginning work.**
2. **DO NOT turn on or move car whilst any camera or radar systems are disconnected. Failure to observe this precaution will result in system errors that will need car to be taken to Ford Dealership to resolve. Keep proximity keys away from vehicle and out of range to minimize the chances of computers activating whilst modules are disconnected.**
3. Open the Bonnet
4. Remove scrivets securing the top radiator cowling. Unscrew center section with Phillips screwdriver to unlock, then remove clip with trim tool.
5. Retain all clips for reassembly

TOOLS REQUIRED

Trim Tool
Phillips Screwdriver

FASTENERS

Retain Factory

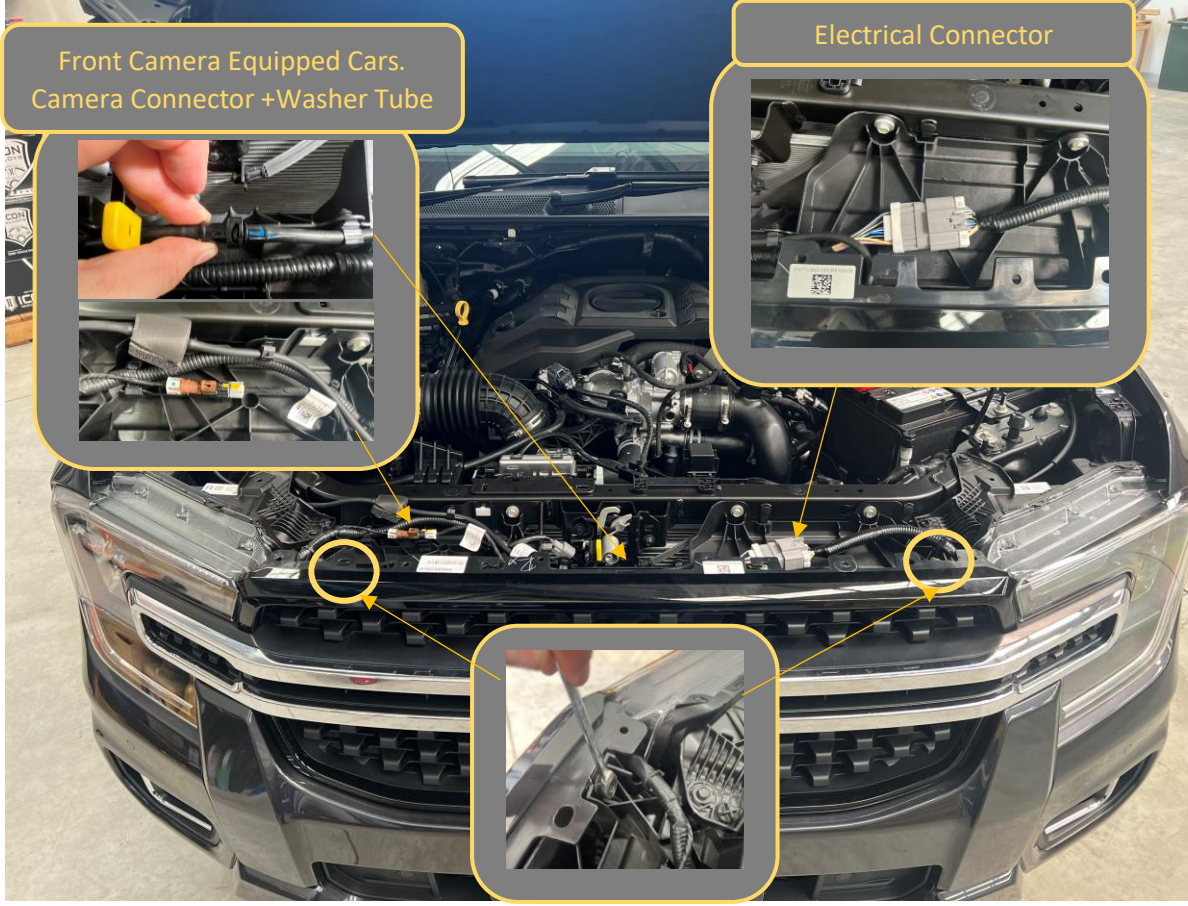
	
<p>6. Remove the 2x Bolts securing top of grille to body using 8mm socket.</p> <p>7. Disconnect the main electrical harness connector camera, camera connector and camera washer fluid connector (360 Camera equipped vehicles)</p>	<p>TOOLS REQUIRED</p> <p>8mm socket or spanner.</p>
<p>FASTENERS</p> <p>Retain Factory</p>	



8. Remove the 8mm deep head screws securing the bumper to the lower crossmember. The other shallower head screws do not need to be removed
9. Remove the Torx screw that secures the bottom of the flare to the bumper.
10. Complete for both sides of the vehicle.

TOOLS REQUIRED

8mm socket
T25 Torx Driver

FASTENERS

Factory Bolts (Discard)

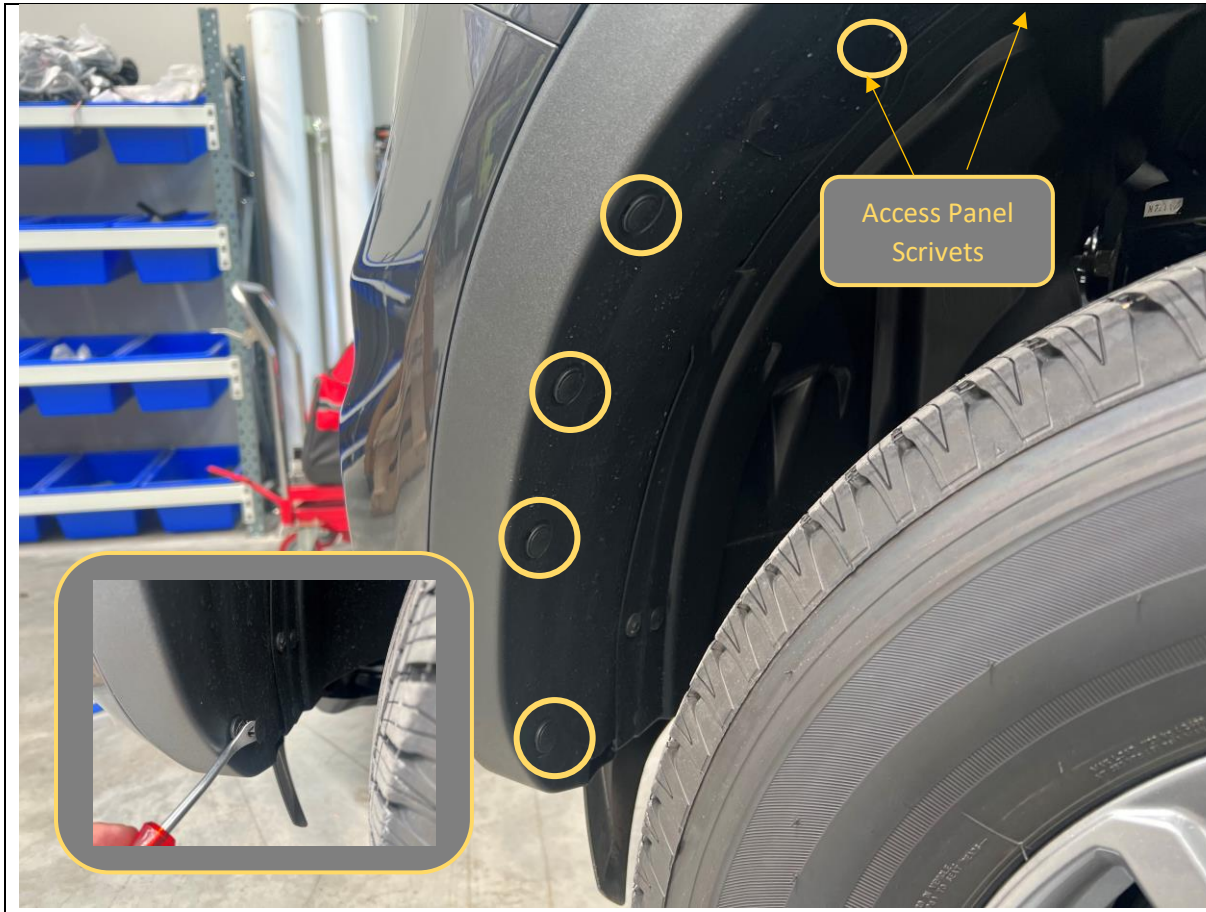

11. Remove clips securing wheel arch flare and inner guard liner by prying up center part of clip using a trim tool.

12. There are 4x flat head clips securing each flare.

13. Remove the lower two scrivets on the access panels on the wheel arch liner. This will allow the access panel to swing away giving access to the bumper bolts.

TOOLS REQUIRED

Trim Tool

FASTENERS

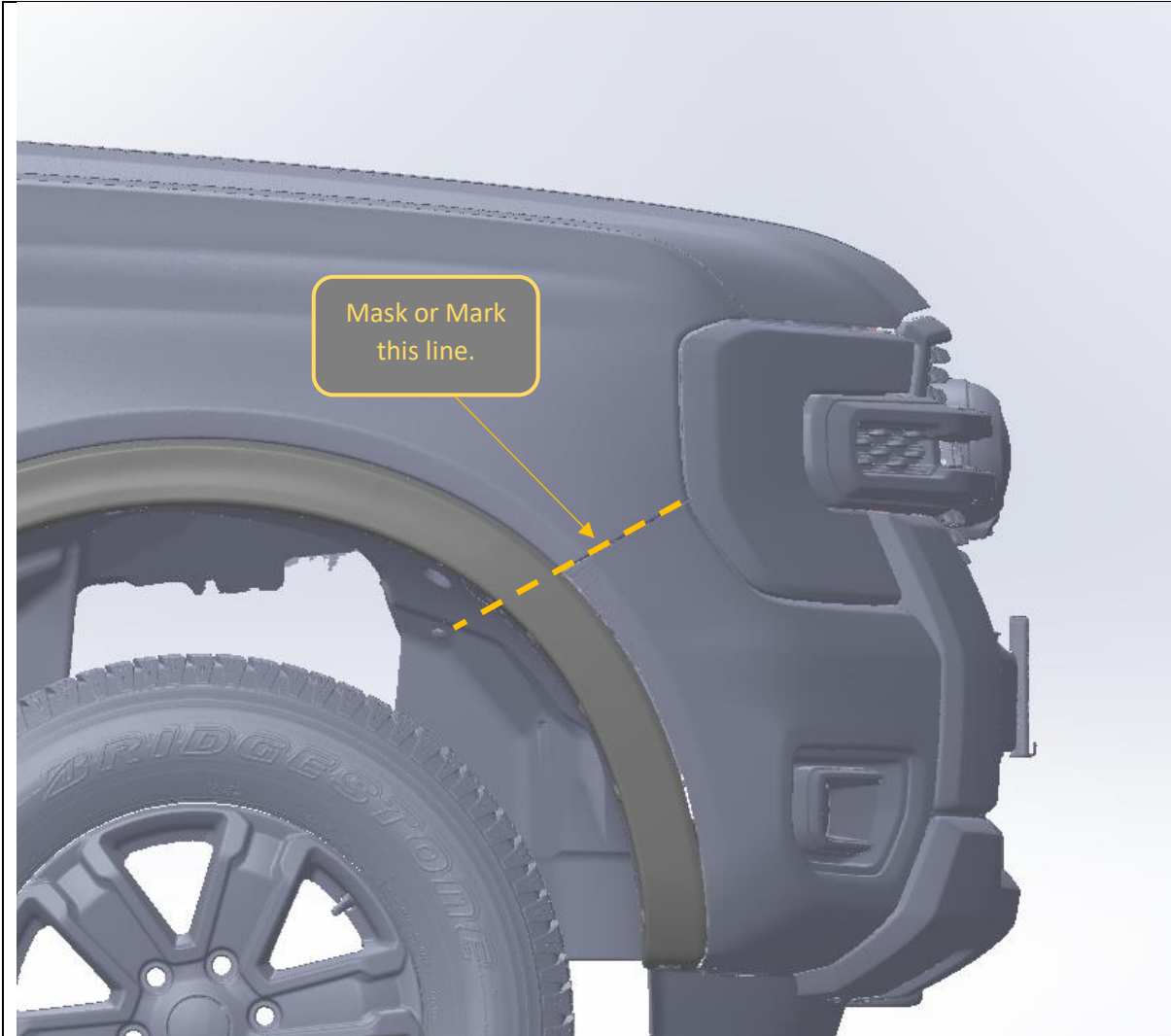

14. Before removal of the flare, place masking tape / mark the flare in line with the bumper to guard panel line, this will assist in trimming flare later.

TOOLS REQUIRED

Masking Tape or
Marker

FASTENERS



15. Progressively release the clips securing the wheel arch flare to the bumper. Start from the bottom corner of the flare towards the front of the vehicle. Stop once the flare is free from the front guard.
16. **IMPORTANT:** Remove the two concealed scrivets behind the flare securing the arch liner to the bumper
17. For high spec vehicles with 6x Parking sensors, remove the sensor from the housing in the flare and temporarily stow sensor in bumper.

TOOLS REQUIRED

Trim Tool

FASTENERS

Factory Clips



18. Remove number plate from the front of the vehicle.
19. Remove the number plate plinth by removing the two 8mm head screws securing it to the bumper. Then pull off to release the clips securing bottom edge.
20. Complete on both sides of the vehicle.

TOOLS REQUIRED

8mm Socket / Spanner

FASTENERS

Discard Factory

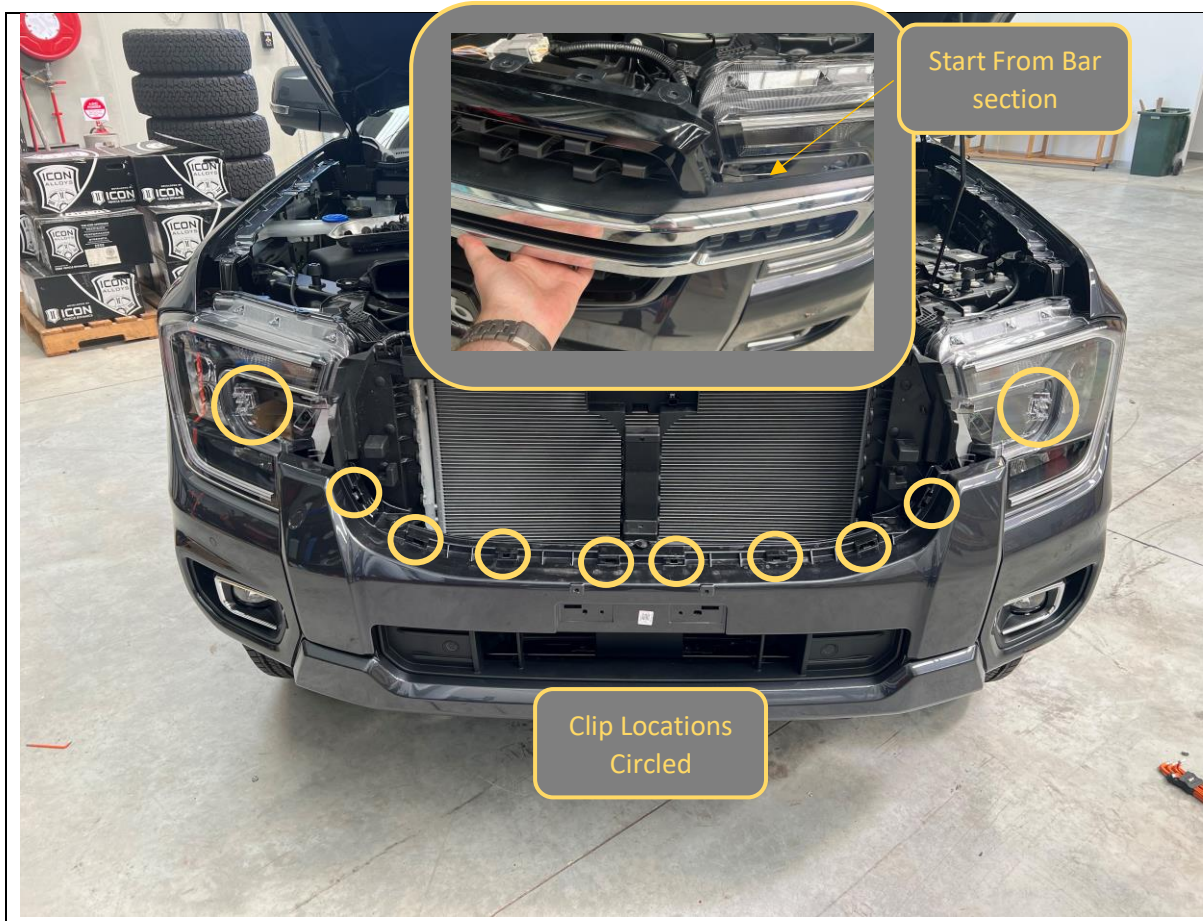

<p>21. Remove the grille from the vehicle.</p> <p>22. The grille is secured by molded clips in the locations shown in the photo above.</p> <p>Firmly pull the grille away from the bumper to release the clips.</p> <p>Start from the “Bar” section as shown and progressively release the clips to enable the grille to be removed.</p>	<p>TOOLS REQUIRED</p>
<p>23. If Relocating Front Camera – Camera and washer can be removed from grille. Refer to Camera relocation kit instructions.</p>	<p>FASTENERS</p>

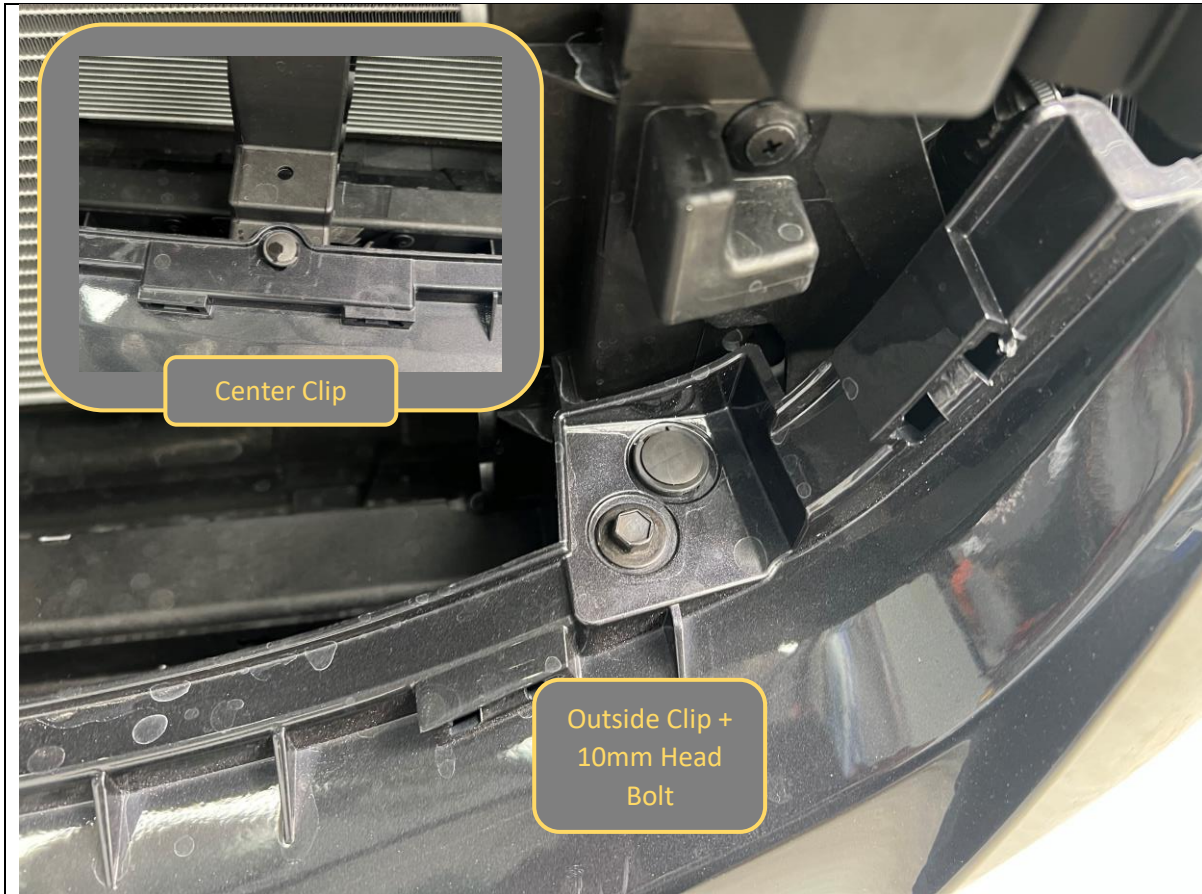

24. Remove 10mm head bolt and clip securing the bumper from each edge underneath the grille.
25. Remove the clip securing the center of the bumper to the radiator support.

TOOLS REQUIRED

10mm Socket
Trim Tool

FASTENERS

Factory Fasteners - Discard



26. Unclip the main wiring harness from all locations where it is secured the radiator support panel.

TOOLS REQUIRED

Trim Tool

FASTENERS

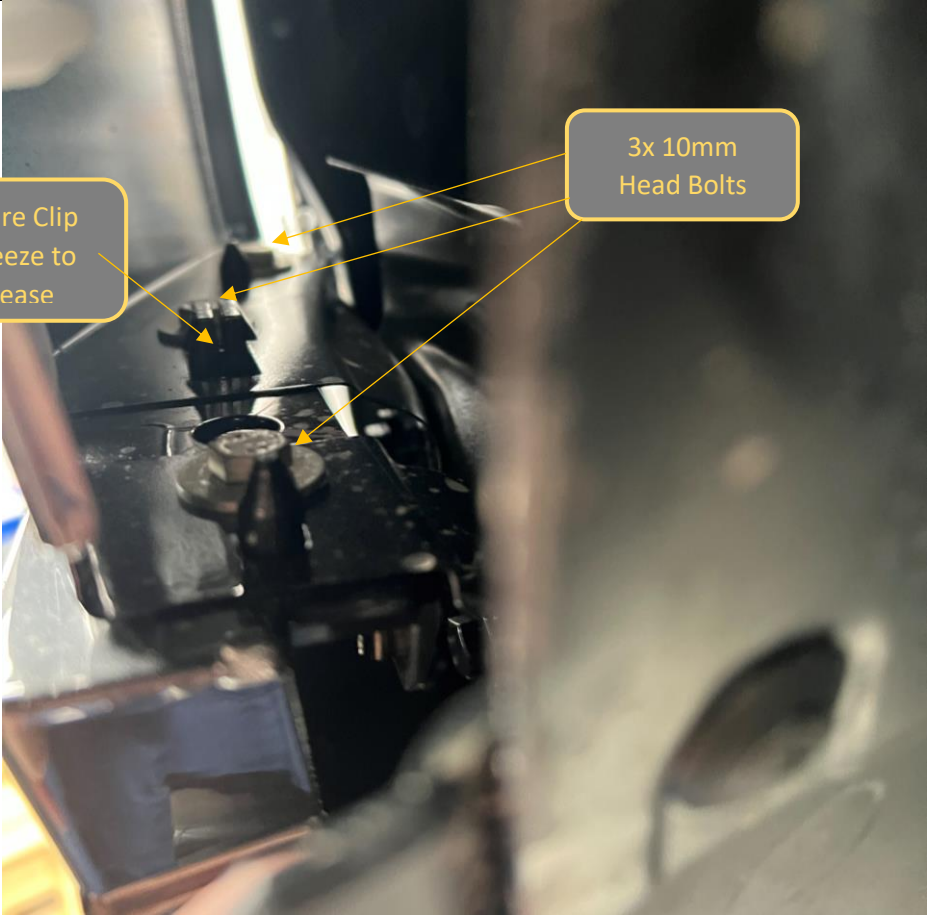
	
<p>27. Looking through the access hatch on the wheel well liner you can see the 3x 10mm head bolts securing the bumper to each side of the vehicle.</p> <p>Remove these 3 bolts. A mini ¼ drive ratchet is the best tool for this job. Complete on both sides.</p> <p>28. Squeeze the sides of the square retaining clip whilst applying gentle downward pressure to the bumper. This may be easier using pliers to squeeze the clip.</p> <p>29. Once the clips are released, remove the bumper from the vehicle and set down on a soft surface such as blanket or panel stand.</p>	<p>TOOLS REQUIRED</p> <p>10mm Mini ratchet Pliers</p> <hr/> <p>FASTENERS</p> <p>Factory 10mm head screws, retain for fitment of infill panels.</p>



30. Disconnect the Fog light harness from the fog light.
31. Remove the fog lights from the bumper, by removing the three Torx head screws.
32. Remove the electrical harness from the bumper by prying out the clips using trim tool.
33. Complete on both sides of bumper.

TOOLS REQUIRED

Torx Head Screwdriver
Trim tool

FASTENERS

Discard Factory Screws

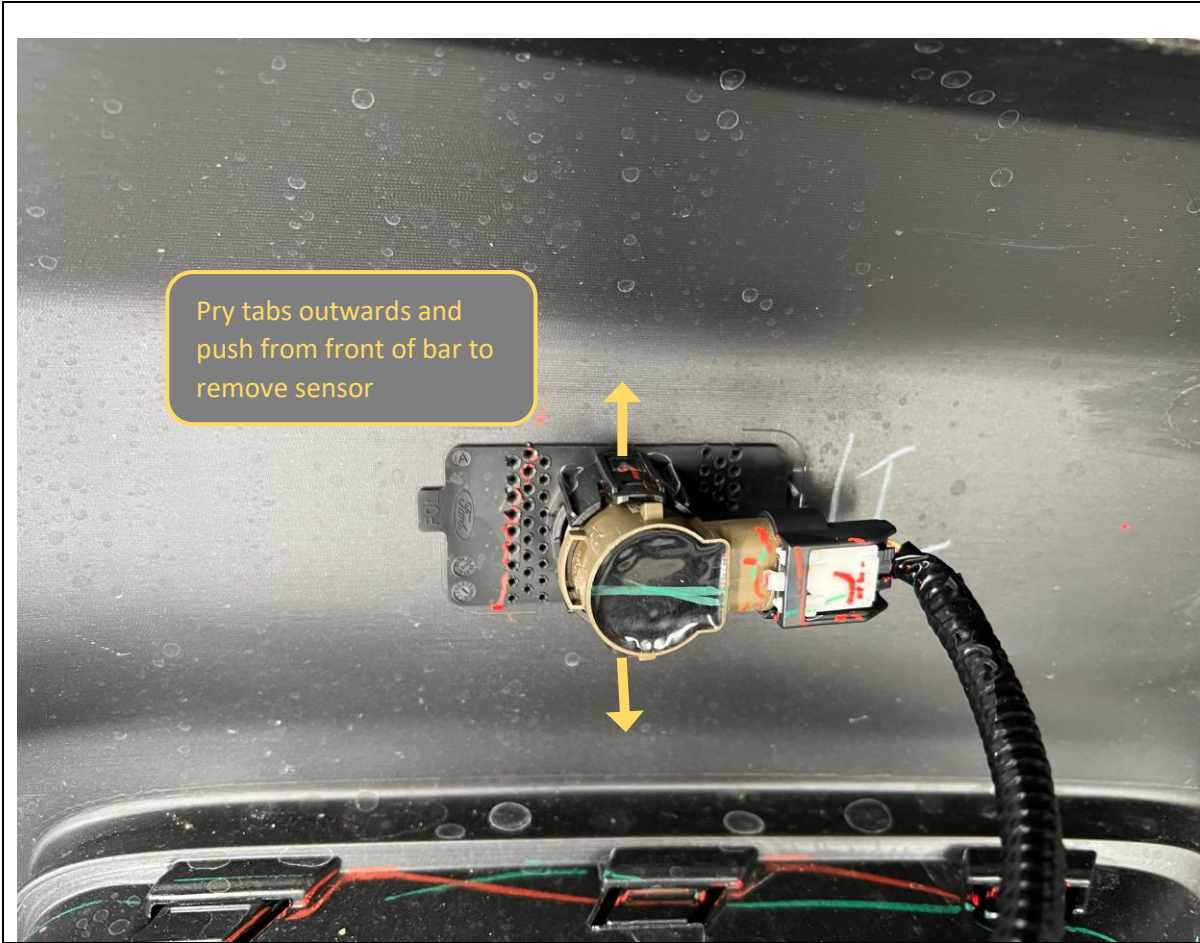

34. Pry the two black retaining tabs on the sensor housing outwards whilst applying pressure to the face of the sensor from the front side of the bumper. The sensor should release from the housing. Remove from the rear side of the bumper.

Take care to ensure the rubber isolation rings remain in place with the sensor

TOOLS REQUIRED

FASTENERS



<p>35. Remove the Foam covering the impact beam.</p> <p>36. The plastic is secured by clips in the front face, and molded clips on either end of the beam. Remove the visible clips and pull to remove.</p> <p>37. Remove and set aside the foam impact beam.</p>	<p>TOOLS REQUIRED</p>
	<p>FASTENERS</p>

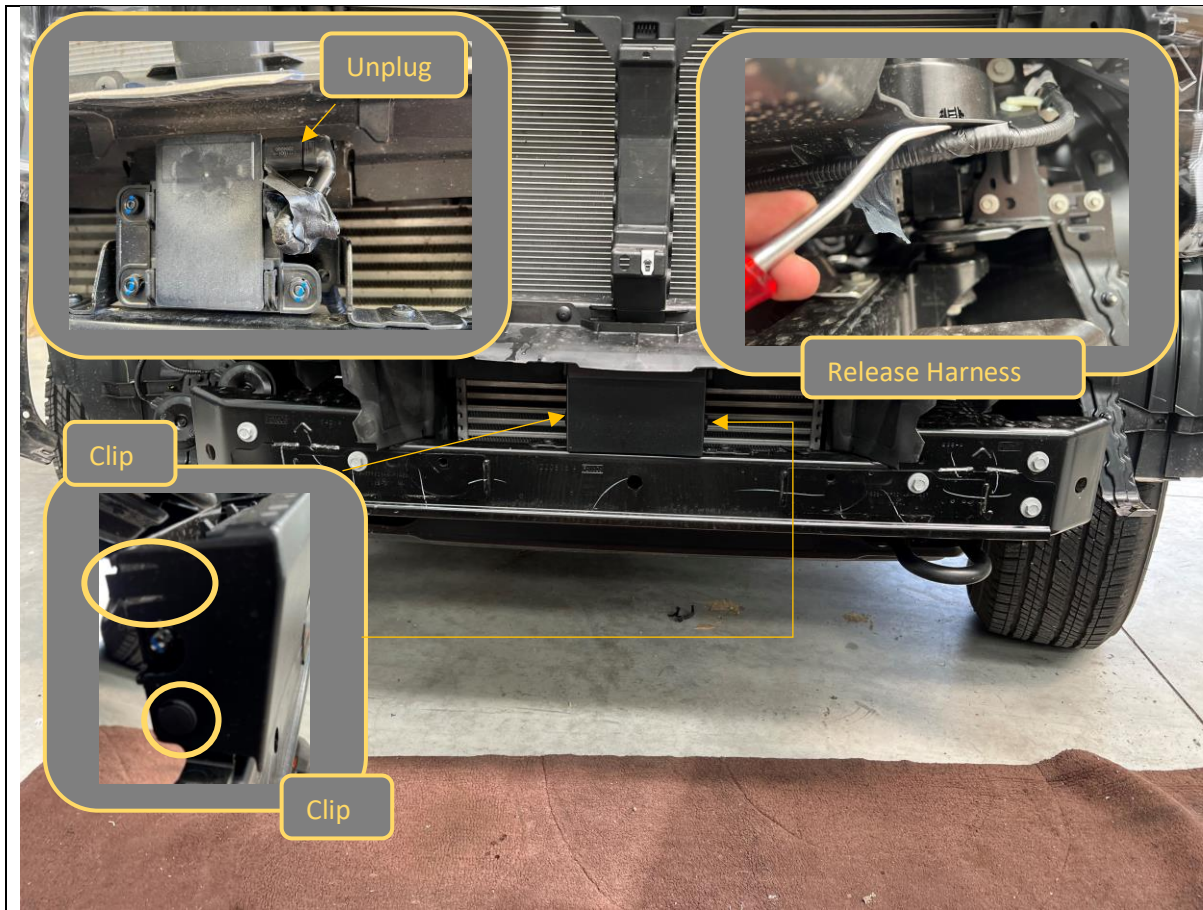

38. Remove the Plastic radar cover by removing the two clips securing the bottom on the sides and two molded clips on the top side.
39. Unplug the radar module wiring harness connector.
40. Release all clips securing the radar wiring harness to the impact beam and plastic air guides using a trim tool.

TOOLS REQUIRED

10mm socket / spanner
Trim tool

FASTENERS



41. Remove Impact beam by removing the 6x M8 Bolts securing it to the chassis.
42. Retain bolts for fitment of impact assemblies.
43. Mark the plastic air guide through the narrowest points as shown by the red dashed lines on the images above.

TOOLS REQUIRED

13mm socket / spanner

FASTENERS

Factory M8 Flange Bolts - Retain



44. Remove the plastic air guide by removing the scrivets and 10mm head bolts securing to the vehicle.

45. Trim the air guide along the line marked earlier and re-fit top portion to car using original fasteners.

TOOLS REQUIRED

Trim Tool
Phillips Screwdriver
10mm Socket

FASTENERS

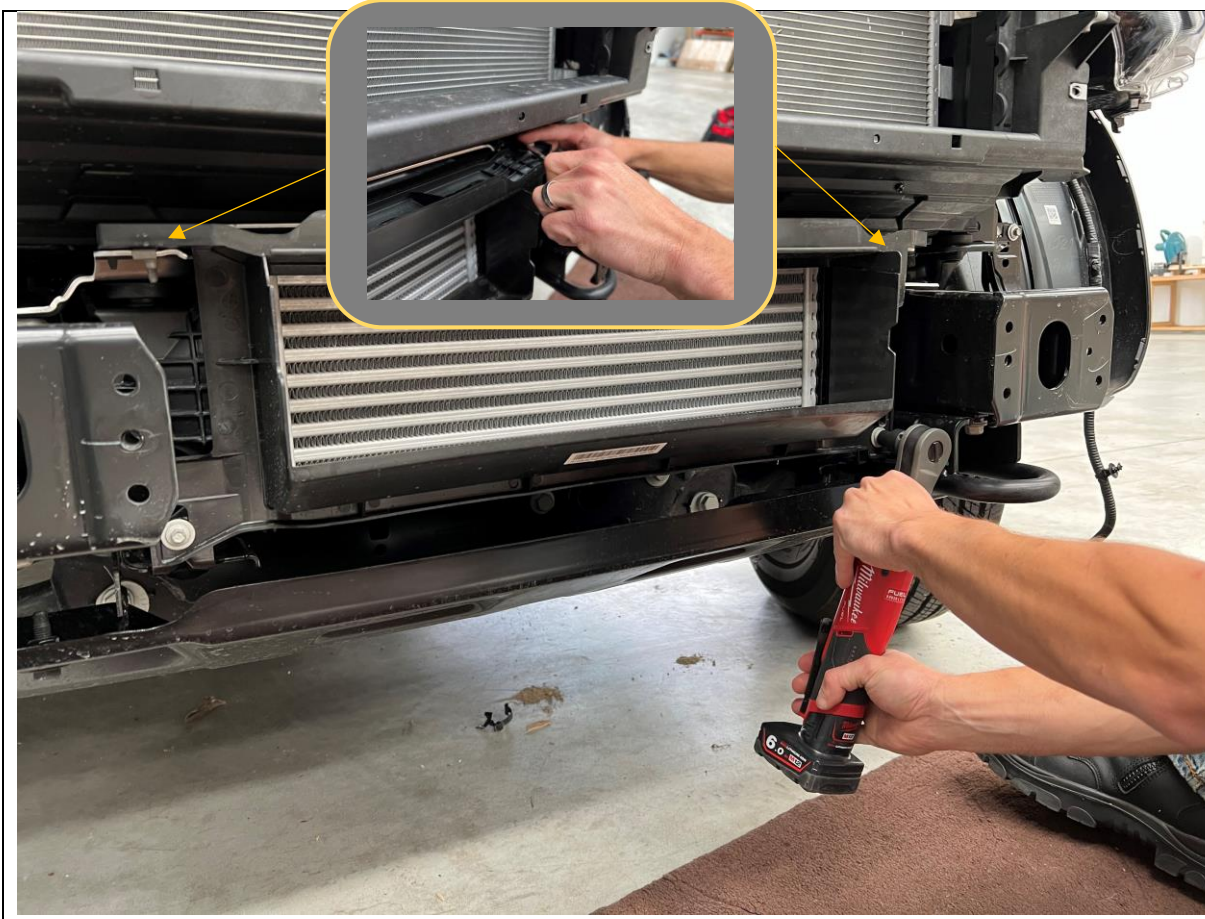

46. Remove Intercooler air guide by removing the 4x bolts (2x top 2x front) securing it.

TOOLS REQUIRED
8/10mm Socket
8/10mm Spanner

FASTENERS
Factory Flange Bolts

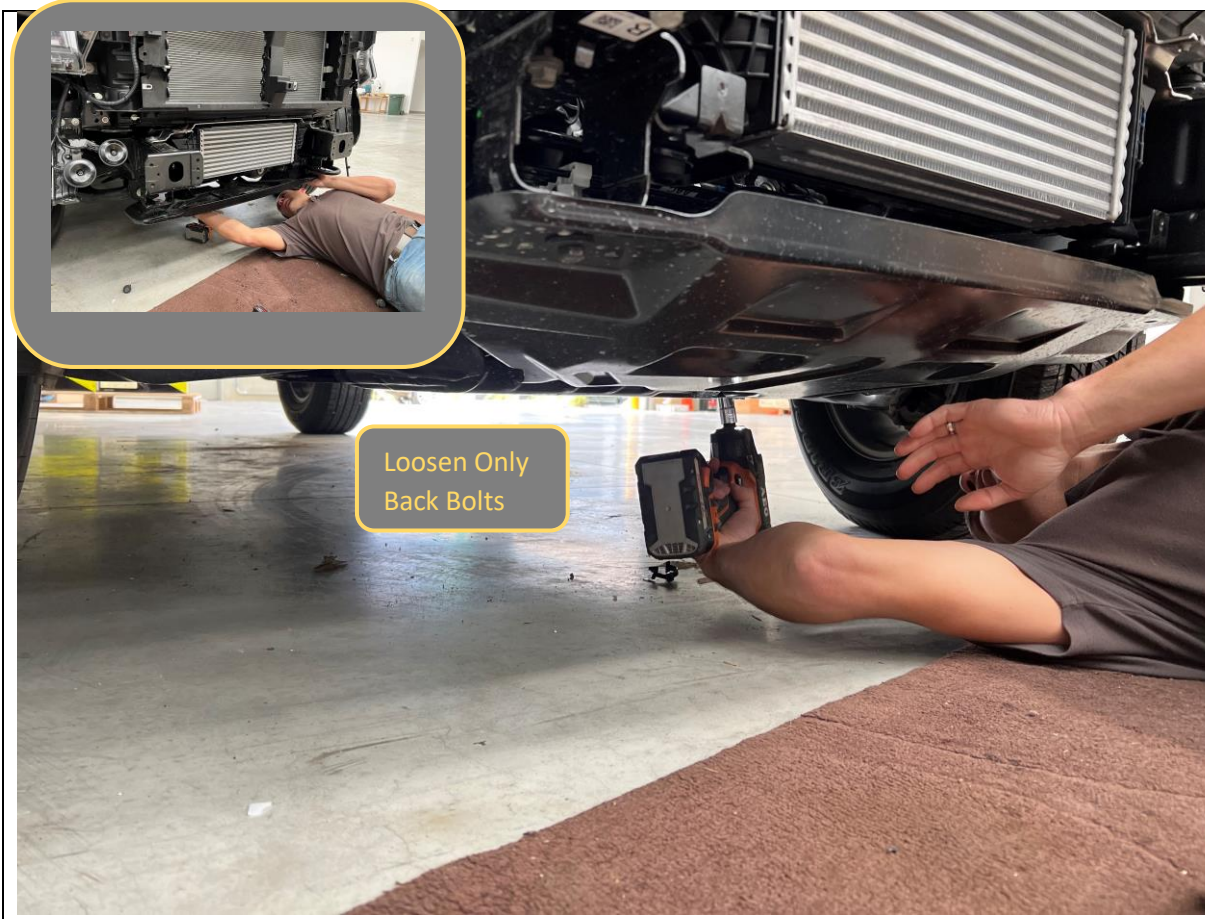

<p>47. Remove lower bash plate.</p> <p>48. First loosen only the rear 15mm head factory flange bolts.</p> <p>49. Whilst supporting bash place remove two front bolts. Then remove bash plate toward front of the car.</p>	<p>TOOLS REQUIRED</p> <p>15mm Socket</p>
	<p>FASTENERS</p> <p>Factory Flange Bolts - Retain</p>

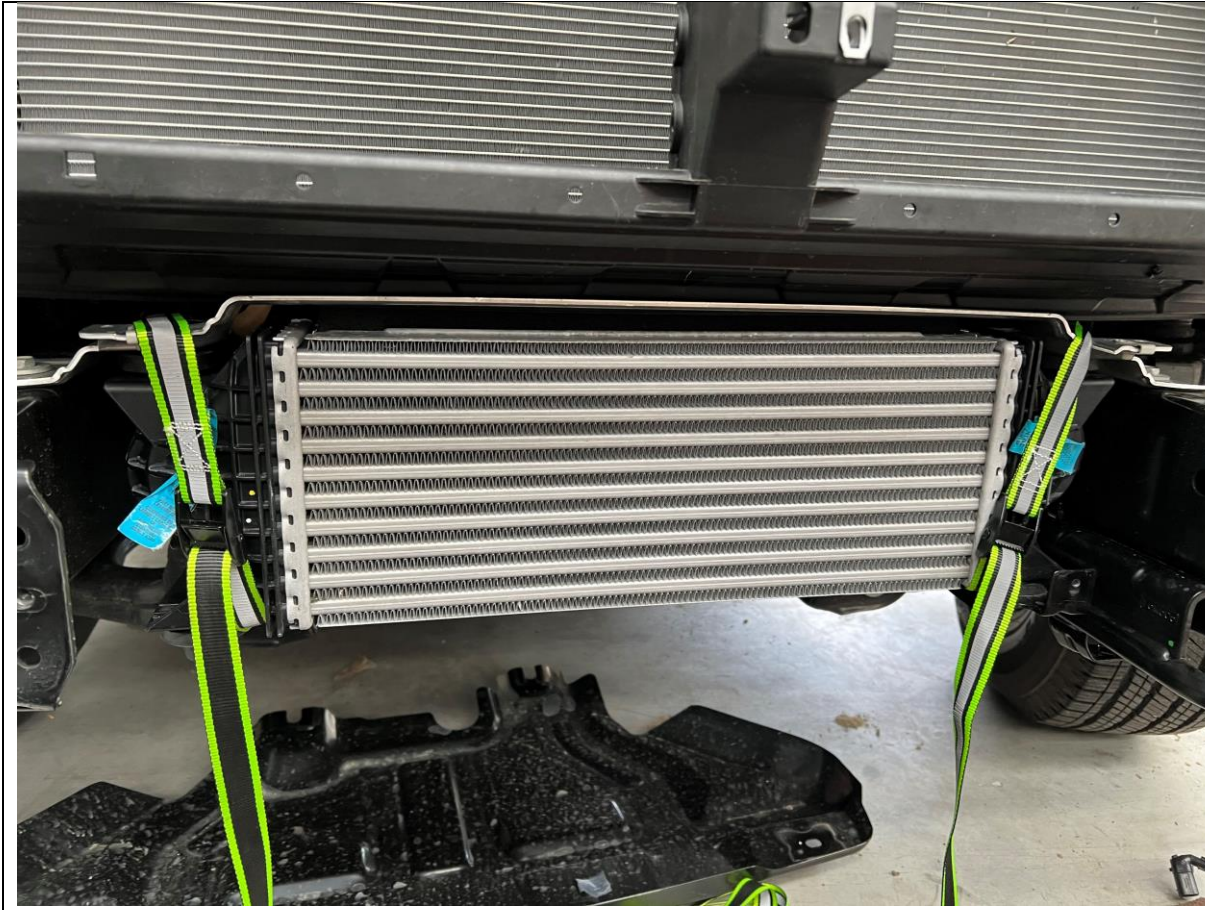

50. Temporarily support the intercooler by strapping to the upper intercooler support brackets.

51. This is best done with relatively short camlock straps or similar, Ensure the straps do not obstruct the lower rubber intercooler mounts

TOOLS REQUIRED

Camlock Straps

FASTENERS

Phillips Head screw.
Discard

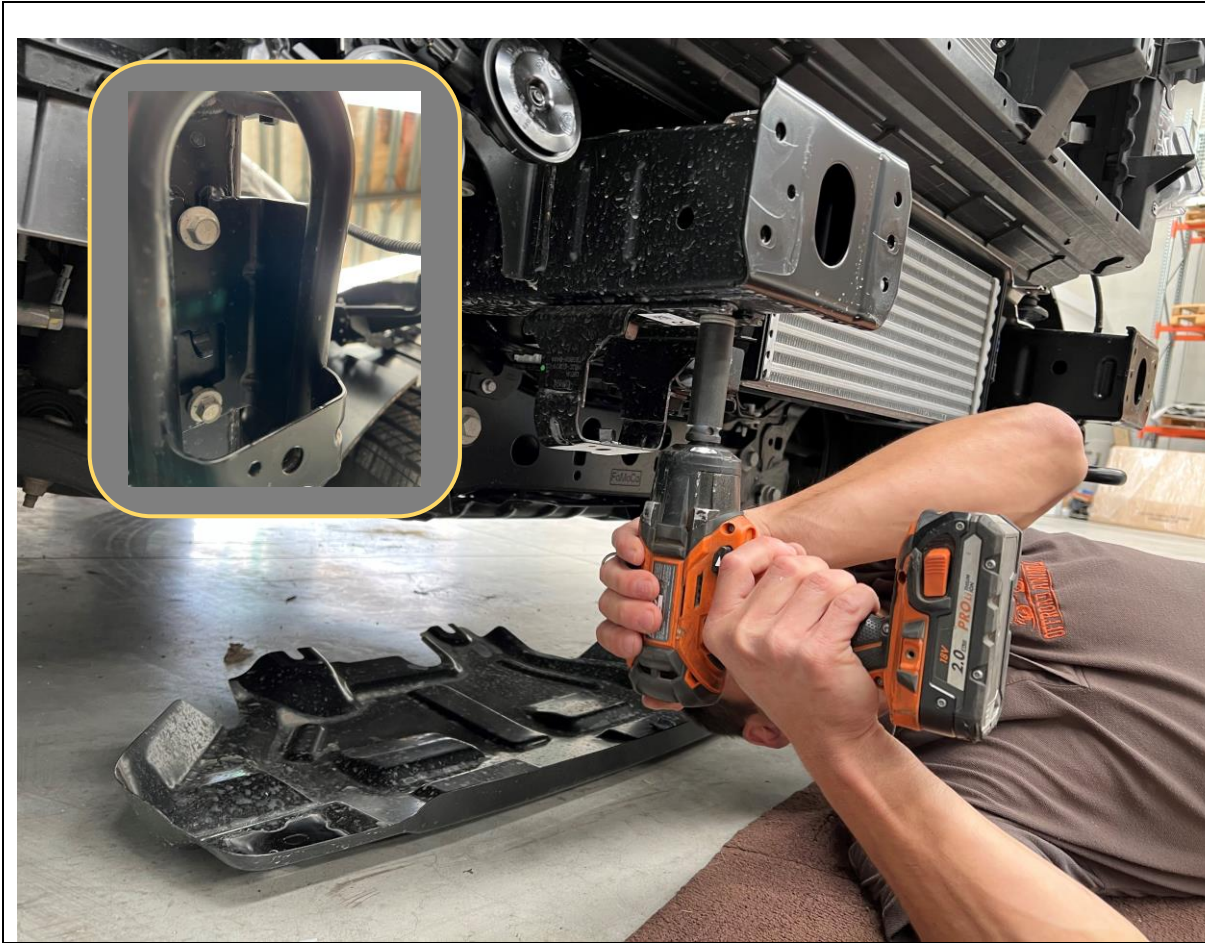

- 52. Remove the two 17mm head factory flange bolts securing the factory tow point / intercooler supports on both sides.
- 53. A extension bar can make reaching the rearmost bolt easier.
- 54. Retain factory Flange Bolts for Re-Fitment of Offroad Animal Tow points

TOOLS REQUIRED

17mm Socket / Spanner
Extension Bar

FASTENERS

Factory Flange Bolts - Retain

<p>55. Remove the dropper bracket securing the horns to the body under the headlight on the RHS side. Also remove dropper bracket on other side of vehicle.</p> <p>56. Remove the horns from the bracket and re-fit, in inverted position to the captive nuts in the body the dropper bracket was removed from, using original fasteners.</p> <p>57. Everest vehicles have horn located elsewhere, and relocation is not required, just remove the dropper brackets.</p>	<p>TOOLS REQUIRED</p> <p>8/10mm Socket / Spanner</p> <hr/> <p>FASTENERS</p> <p>Factory Flange Bolts - Retain</p>

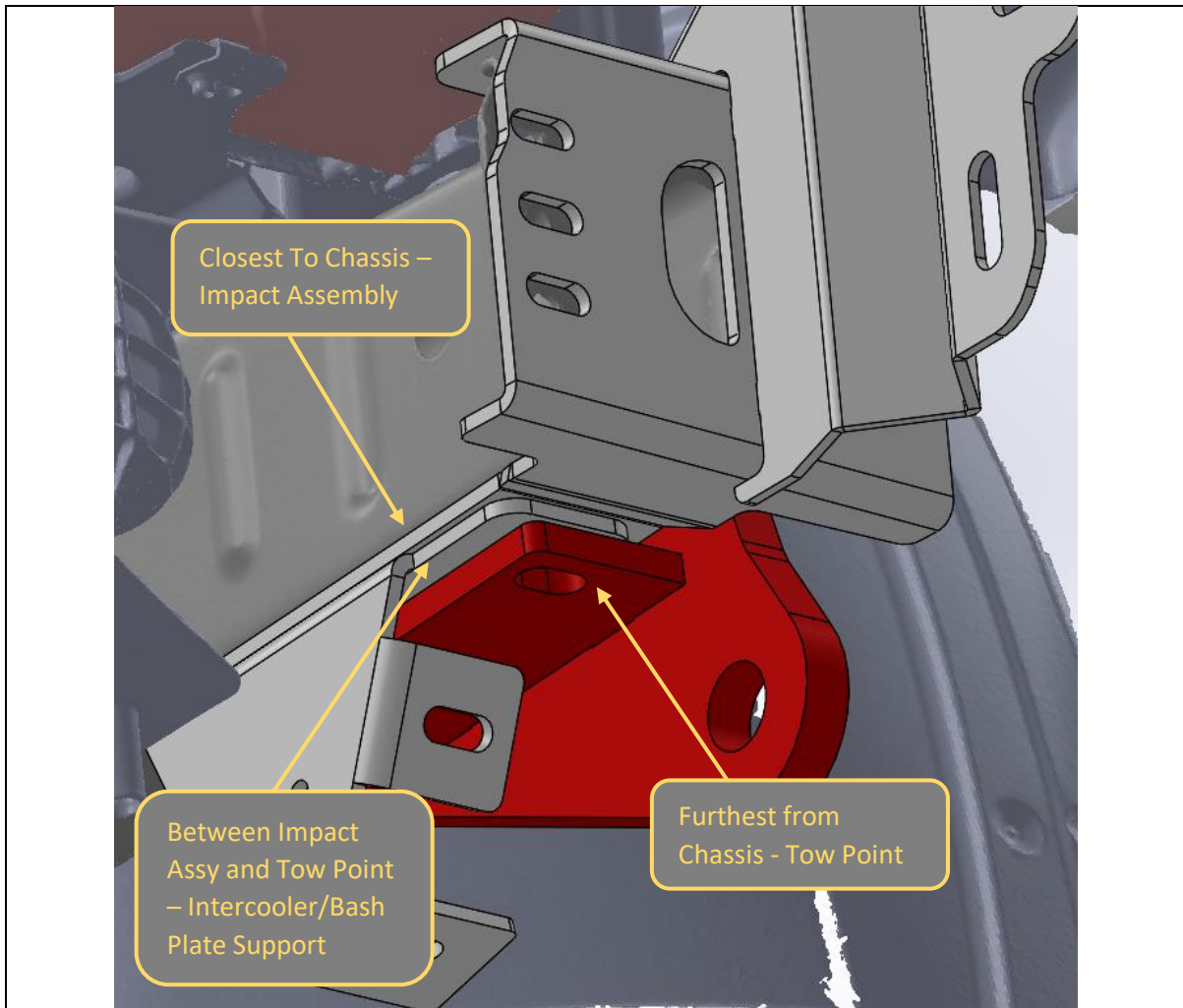

58. Identify and unpack the Impact assembly, Tow point and Intercooler / bash plate support bracket for each side.
59. Loosely fit the parts to the vehicle chassis in the order shown in the above Image. THIS ORDER IS IMPORTANT
60. Secure from below with Factory Flange bolts into the captive nuts in the chassis.

TOOLS REQUIRED

FASTENERS
2x Factory Flange Bolt

Per side

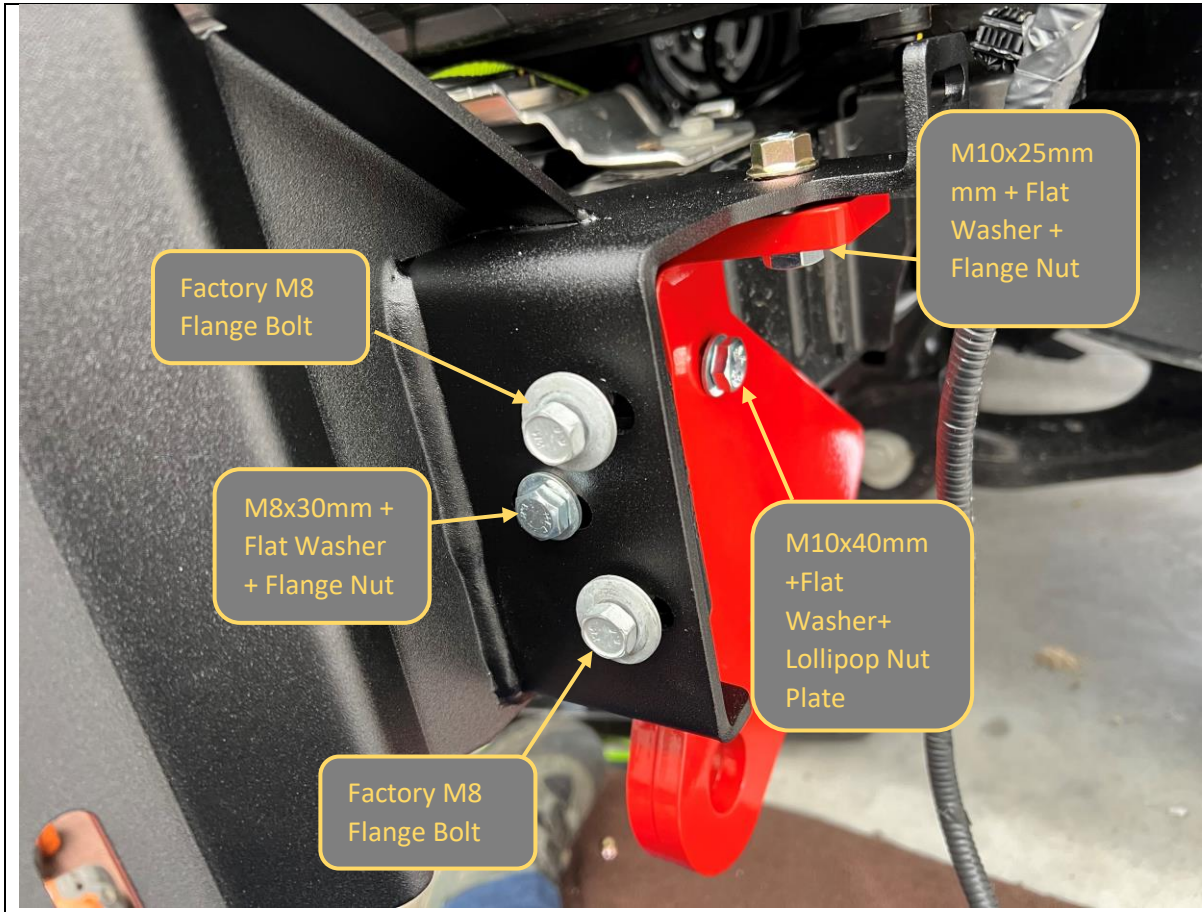

61. Fit Remainder of bolts to tow point and impact assembly as shown in above image.
62. Re-use Factory M8 Flange bolts from impact beam in locations where captive nuts are in chassis rail.
63. Leave all bolts that secure tow point and impact assembly, including the bottom flange bolts that go through chassis loose at this stage

TOOLS REQUIRED

FASTENERS

As shown in image

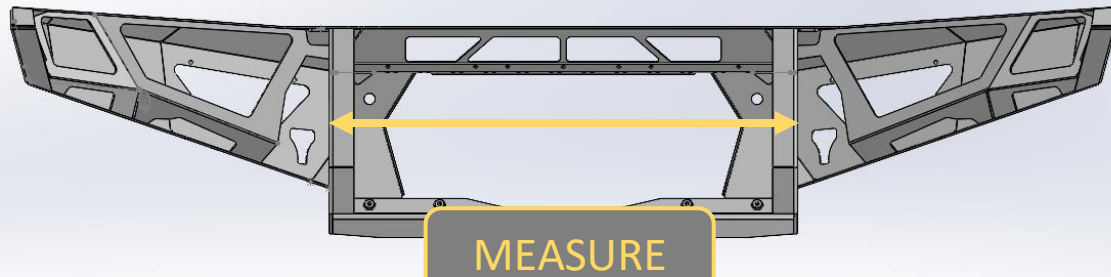

64. Measure Distance between outside edges uprights on bar using tape measure. Write distance below for reference if required.

Bar Upright Width = _____mm

65. Adjust mounts by sliding mounts on slots, such that distance between outside edges of mounts is approximately 2mm less than bar.

66. Secure and tighten mounts. Tighten bolts that secure the tow point to chassis first, then impact assembly to tow point bolts then finally impact assembly to chassis bolts.

TOOLS REQUIRED

TAPE MEASURE

FASTENERS



- 67. Once mounts are tight, fit the Intercooler supports to the support bracket, using 2xM8x20 Hex Bolts, Flat washers and Flange Nuts
- 68. Press support snugly against the rubber intercooler boss and tighten bolts.
- 69. Complete on both sides. Once intercooler is supported remove temporary support straps.

TOOLS REQUIRED

13mm Spanner / Socket

FASTENERS

2xM8x20
2xM8 Flat Washer
2x M8 Flange Nut



70. Prepare bar for fitment. Start by routing the Wiring harness through the bar such that all plugs are in the correct location. The main harness connector should sit to the OUTSIDE of the bar upright on the LH side of the vehicle.

71. Fit the fog lights to the fog light brackets. There are two different types of fog light fitted depending on model grade. (3 bolt or 4 bolt) Use the bracket that matches the light removed from the vehicle.

72. Fit the fog light brackets to the Mesh Panels, using the supplied M8x12 Bolts. Fog lights should face straight ahead when fitted.

TOOLS REQUIRED

4mm Allen Key
10mm Spanner / Socket

FASTENERS

4x M6x16 BHCS – Black
4x M6 Flat Washer
4x M6 Flange Nut
per Side
2xM8x12
2xM8 Flat Washer
2x M8 Flange Nut



73. Prepare bar for fitment. Start by routing the Wiring harness through the bar such that all plugs are in the correct location. The main harness connector should sit to the OUTSIDE of the bar upright on the LH side of the vehicle.

74. Fit the indicator repeater lamps to the indicator brackets, using Phillips head Screws and the adhesive backing included with the lamp module

TOOLS REQUIRED

Phillips Head Screwdriver

FASTENERS

Phillips Head Screws



TORO BARS ONLY

- 75. Insert the M6 Cage nut into the square hole in the top corner of the Mesh panel.
- 76. Fit the fog lights to the fog light brackets. There are two different types of fog light fitted depending on model grade. (3 bolt or 4 bolt) Use the bracket that matches the light removed from the vehicle.
- 77. Fit the fog light brackets to the Mesh Panels, using the supplied M8x12 Bolts. Fog lights should face straight ahead when fitted.
- 78. Finally fit the indicator brackets to the mesh panel, using the supplied M6 Fasteners. The indicator should be located centrally in the cutout.

TOOLS REQUIRED

4mm Allen Key
10mm Spanner / Socket

FASTENERS

2x M6x16 BHCS – Black
2x M6 Flat Washer
2x M6 Flange Nut

2xM8x12
2xM8 Flat Washer
2x M8 Flange Nut
per Side



79. Fit Light mesh panels to the bar using M6X16 Button head Bolts, Flat washers, and Flange nuts from the Small Parts Kit.
80. Secure and tighten using 4mm Allen Key and 10mm Spanner

TOOLS REQUIRED

4mm Allen Key
10mm Spanner / Socket

FASTENERS

4x M6x16 BHCS – Black
4x M6 Flat Washer
4x M6 Flange Nut
Per Side

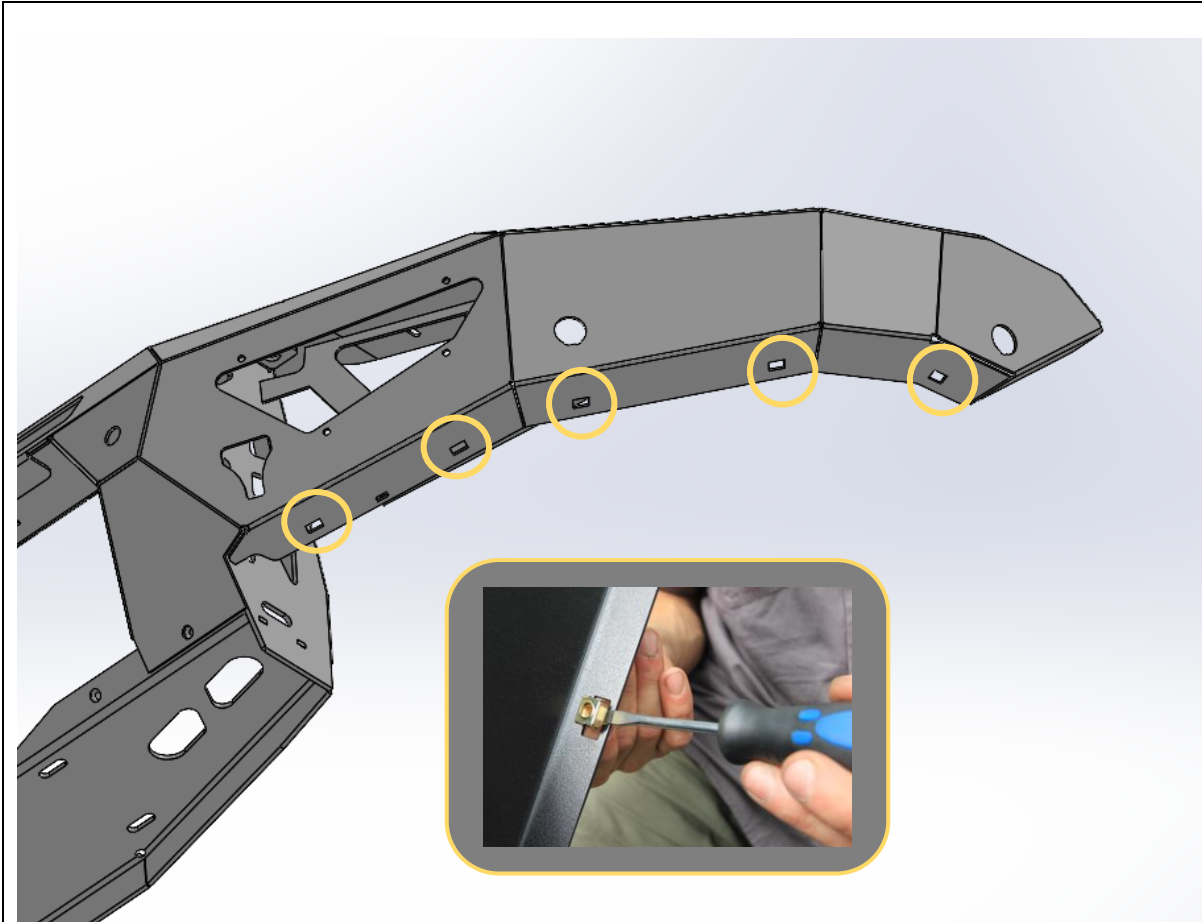

81. Fit 5x Cage nuts from small parts kit to rectangular slots in bottom of wing.

Use a small flat bladed screwdriver to push the edge of the cage to engage with the slot to aid fitting.

82. Repeat for other side of Bar

TOOLS REQUIRED

Small Flat Bladed Screwdriver

FASTENERS

5x M6 Cage Nut
Per side



- 83. Fit the inner infill panels to the bar using supplied M6x16 button head bolts, Flat washers, and flange nuts.
- 84. Ensure head of bolt on bottom to allow tightening after fitment. Leave finger tight only at this stage

TOOLS REQUIRED

FASTENERS

- 2x M6x16 BHCS – Black
- 2x M6 Flat Washer
- 2x M6 Flange Nut
- Per Side

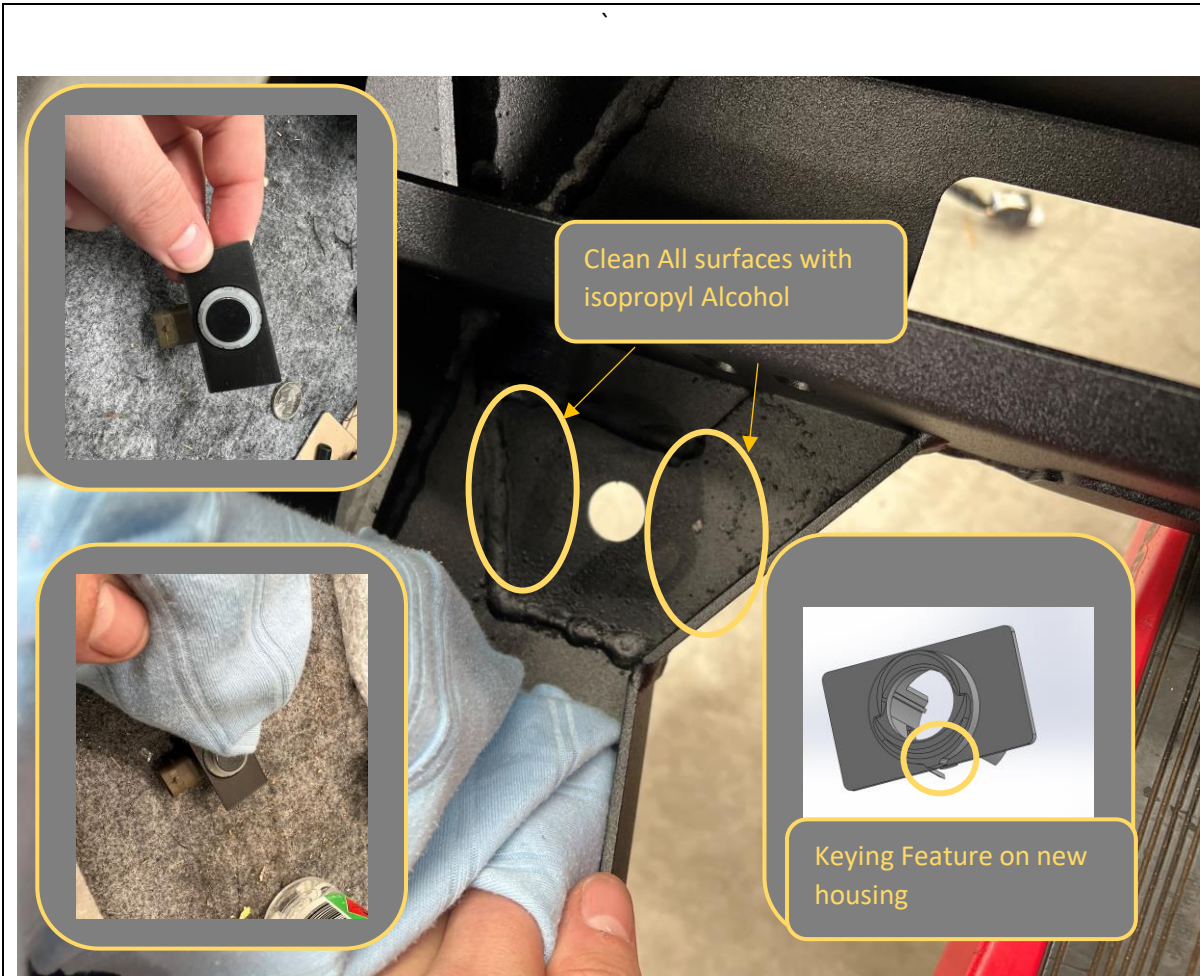

Clean All surfaces with isopropyl Alcohol

Keying Feature on new housing

<p>85. Re Fit parking sensors to the bar using the following procedure</p> <p>86. Clean area on back side of bar adjacent to sensor holes with isopropyl alcohol.</p> <p>87. Fit parking sensors to new supplied housings to help locate housing during adhesive process</p>	<p>TOOLS REQUIRED</p> <p>Isopropyl Alcohol, Rag</p>
<p>88. Check keying features on housings to ensure correct positioning of sensors.</p> <ul style="list-style-type: none"> - Far outside – 1x Notch (high spec only) - Mid Outside – 2x Notch - Inside - Flat 	<p>FASTENERS</p>



89. Break the bulb of the supplied Primer 94 ampule to activate the primer dispensing.

90. Apply Primer 94 to all areas adjacent to the parking sensor locations, on both the bar and the sensor housings.

91. Apply supplied VHB tape pads to all sensor housings as shown in the inset photo.

92. Dry fit sensors to bar to check loom position is correct.

93. Remove backing and adhere sensors in position in bar. Apply pressure for 10-30sec after positioning for best adhesion.

94. Connect all parking sensor loom connectors.

95. If parking sensors are not fitted, fit blanking plug to holes.

TOOLS REQUIRED

FASTENERS
VHB Tape pads
Primer 94 Ampule



96. If fitting an integrated light bar, do so now.
97. The bar is designed to fit an Offroad Animal 22in or light bar. If fitting this light bar, assemble bar with legs out, and it will line up with the slots in the center gusset. Secure with M8 Fasteners supplied with the light bar.
98. The bar can accommodate most other "20-22inch" size light bars.
99. If fitting driving lights or top hoop to the bar this is also the most convenient time to do so. It is still possible later but is more difficult.
100. After fitting driving lights, fit the Pan brace to the back of the bar, between the pan and center gusset using Supplied M6x16 (top) and M6x12 bolts, Flat washers, and Flange Nuts
101. Fit Pinch weld to edge of bar underneath headlights

TOOLS REQUIRED

13mm Spanner / Socket
4mm Hex Key

FASTENERS

Supplied with Light Bar

3x M6x16 Black BHCS
3x M6x12 BHCS
6x M6 Flat washer
6x M6 Flange Nuts



102. Using the same adhesive process as the sensors attach the grille support bracket to the bottom of the grille.
103. The bracket should sit with the offset hole tab towards the top of the grille

TOOLS REQUIRED

FASTENERS
VHB Tape pads
Primer 94 Ampule



104. Re-Fit the grille to the vehicle.
105. Secure top of the grille with original bolts.
106. Secure the bottom grille support bracket to the radiator support with M6x16 Button head bolt, Flat Washer, and Nut from small parts kit.

TOOLS REQUIRED

10mm Spanner / Socket
4mm Hex Key

FASTENERS

1x M6x16 Black BHCS
1x M6 Flat washer
1x M6 Flange Nuts

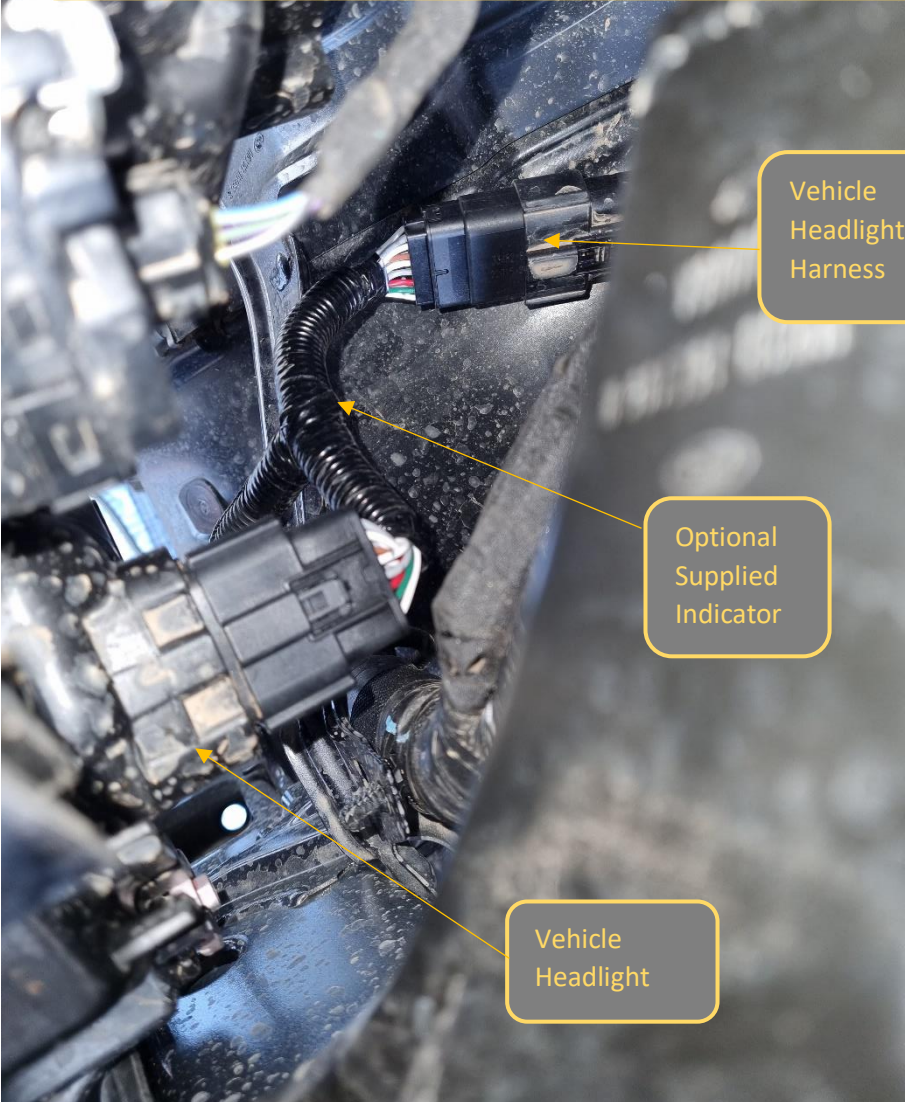
<div data-bbox="379 208 1295 302" style="background-color: #555; color: #fff; padding: 5px; border: 1px solid #ccc;"> TORO BARS ONLY - </div> 	
<p>107. If optional. Fit the indicator harnesses to the vehicle. Refer to Fitting note for LM-FRA-NG-IND for more information.</p> <p>108. Unplug the main headlight harness connector located on the back side of the headlight on both sides.</p> <p>109. Plug in the Indicator breakout harness in-between the vehicle loom and headlight. Ensure the 16 Pin plugs are fully connected to both the headlight and vehicle loom.</p> <p>110. If not using indicator harness, use test light to probe for indicator circuit & earth and splice leads into headlight wiring.</p>	<p style="text-align: center;">TOOLS REQUIRED</p> <hr/> <p style="text-align: center;">FASTENERS</p>

TORO BARS ONLY

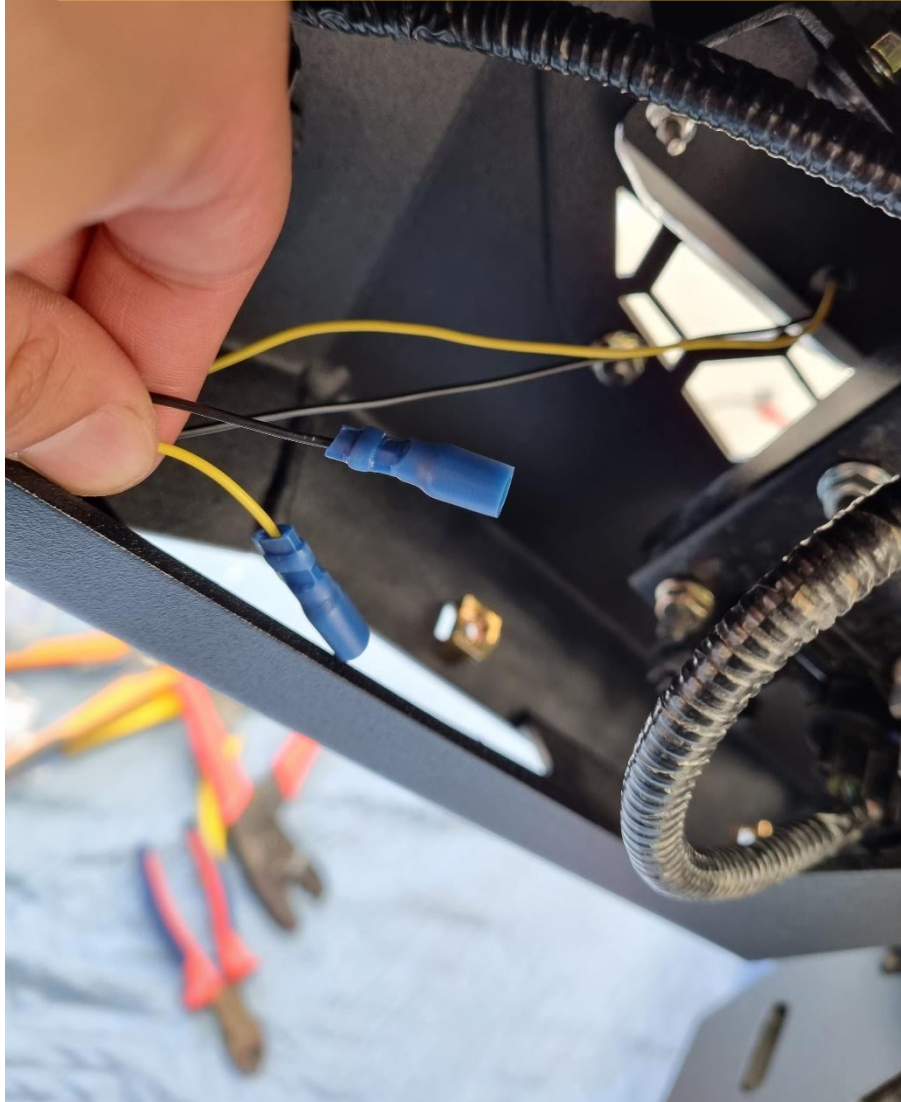

- 111. Fit crimp terminals to the indicator wiring in the bar, and matching terminals to the ends of indicator wiring (coming from the newly installed indicator harness, or spliced into vehicle wiring).
- 112. Color code for indicator lamps is Yellow = +12V Indicator, Black = Ground
- 113. Other wires coming from harness are High Beam headlight triggers, refer to instruction included with loom for more information.
- 114. Complete for both sides of vehicle.

TOOLS REQUIRED

**Wire Stripper
Crimp Tool**

FASTENERS

Crimp Terminals



- 115. Cut the flare along the line colinear with the bumper junction marked with masking tape before the bumper was removed.
- 116. This can be done with an Air Hacksaw, Angle Grinder or Oscillating multi tool. Ensure cut is neat and straight.
- 117. Complete on both sides of the vehicle.

TOOLS REQUIRED

Air Hacksaw
Or
Oscillating multi tool

FASTENERS

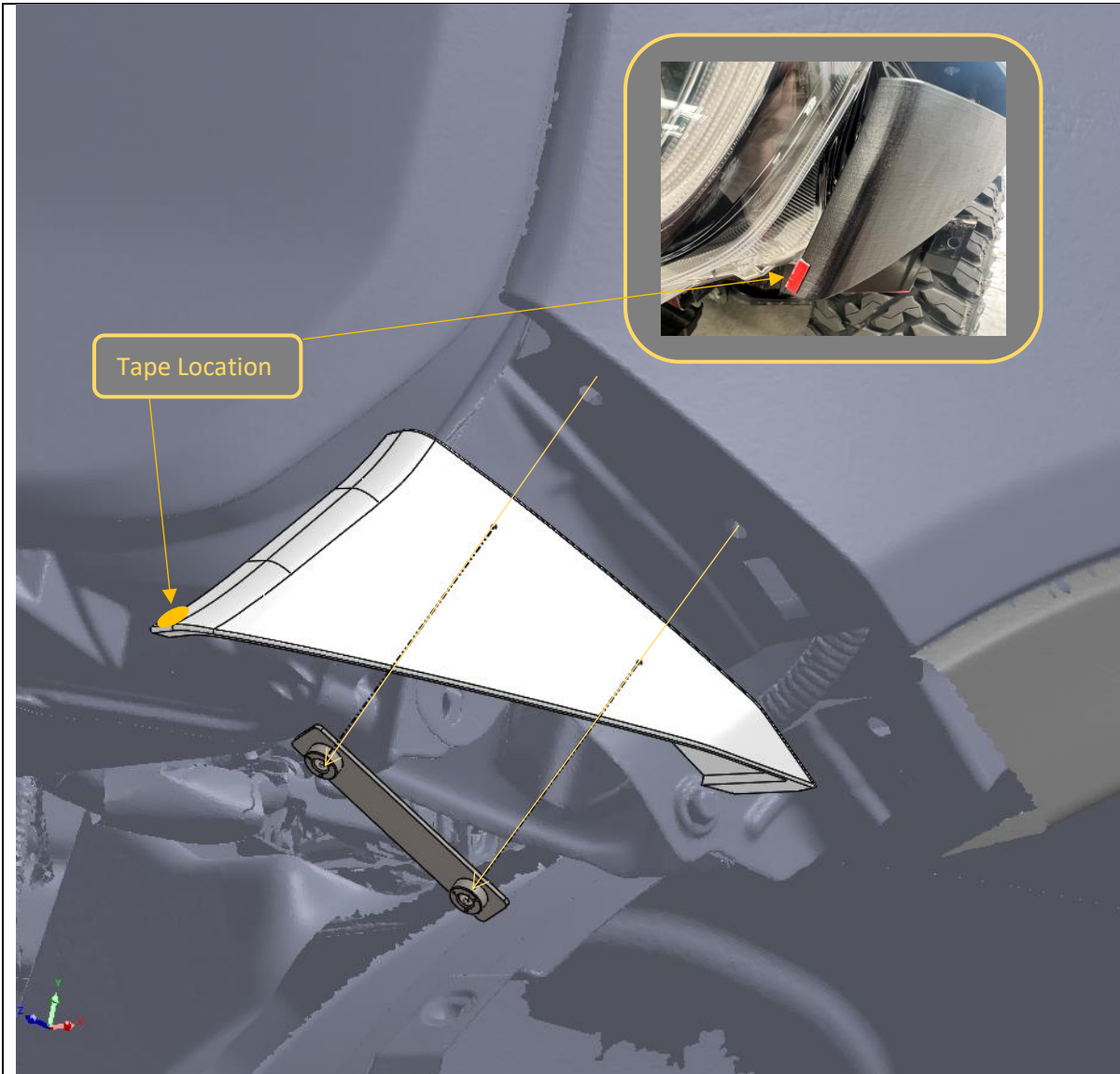

118. Before fitting the outer infill panel cut small pad of 3M VHB tape lengthways and place on end of infill panel in location shown.
119. Fit the infill panel to the guard in the orientation shown. Use OE flange bolts removed from bumper through the access hatch in wheel liner, and secure to nut plate
120. Align panel so that it sits flush with vehicle fender and headlight, then tighten in position. Ensure tape on end bonds to underside of headlight.
121. Repeat for both sides of car.
122. Once infill panels in position close access hatches in wheel arch and secure with Scrivets

TOOLS REQUIRED

10mm Mini Ratchet

FASTENERS

Factory M6 Flange Bolts
M6 Nut Plate



123. With assistance, either from another person, or a lifting trolley, lift the bar onto the mounts on the vehicle.
124. As the bar is fitted briefly unsecure the grille and pass through the wiring harness into its original position
125. Secure with 4x M12x30 Bolts, Heavy Duty washers and M12 Nyloc and Flange Nuts per side, Finger tight at this stage.

TOOLS REQUIRED

Lifting Trolley

FASTENERS

8x M12x30 Bolt
12x M12 Heavy Duty Large Washer
2x M12 Nyloc Nut
12x M12 Flange Nut



126. With assistance, from another person, Align the bar with the edges of the vehicle. Adjust such that the clearances are neat and even side to side.

Acceptable range of clearances shown in image above.

127. Once in position tighten the M12 Bolts using socket and spanner. An impact driver may be used to speed up this process.

128. Once bar is positioned align middle infills such that there is even clearance to the car. TIGHTEN from underneath with 4mm hex key.

TOOLS REQUIRED

Lifting Trolley
18/ 19mm Socket and Spanner
4mm Hex Key

FASTENERS



- 129. If fitting a winch, do so now.
- 130. If winch has top mount control box, the center tab at bottom of grille will need to be cut off to allow clearance. This can be done with side cutters.
- 131. The bar is designed to fit most low mount winches, in foot down configuration. WARN ZEON 12 is largest winch confirmed to fit.
- 132. The control box can be mounted on top of the winch. Winches usually come with a bracket to allow this. Refer to winch manufacturer.
- 133. Ensure clutch handle will be accessible through access hole in front mesh panel. Refer to winch instructions regarding changing clutch handle location.

TOOLS REQUIRED

Refer to winch fitting instructions

FASTENERS

Supplied with winch



134. Fit the radar module to the Radar support plate and radar cover panel using M6x30 Black Button Head Bolts, Flat Washers, and Flange Nuts.
135. Fit the top bolt first. Place 2x Extra Flat washers between the U Bracket and radar module to maintain factory inclination of radar unit.

TOOLS REQUIRED

10mm Spanner
4mm Hex Key

FASTENERS

3x M6x30 Button Head
3x M6 Flange Nut
5xM6 Flat Washer

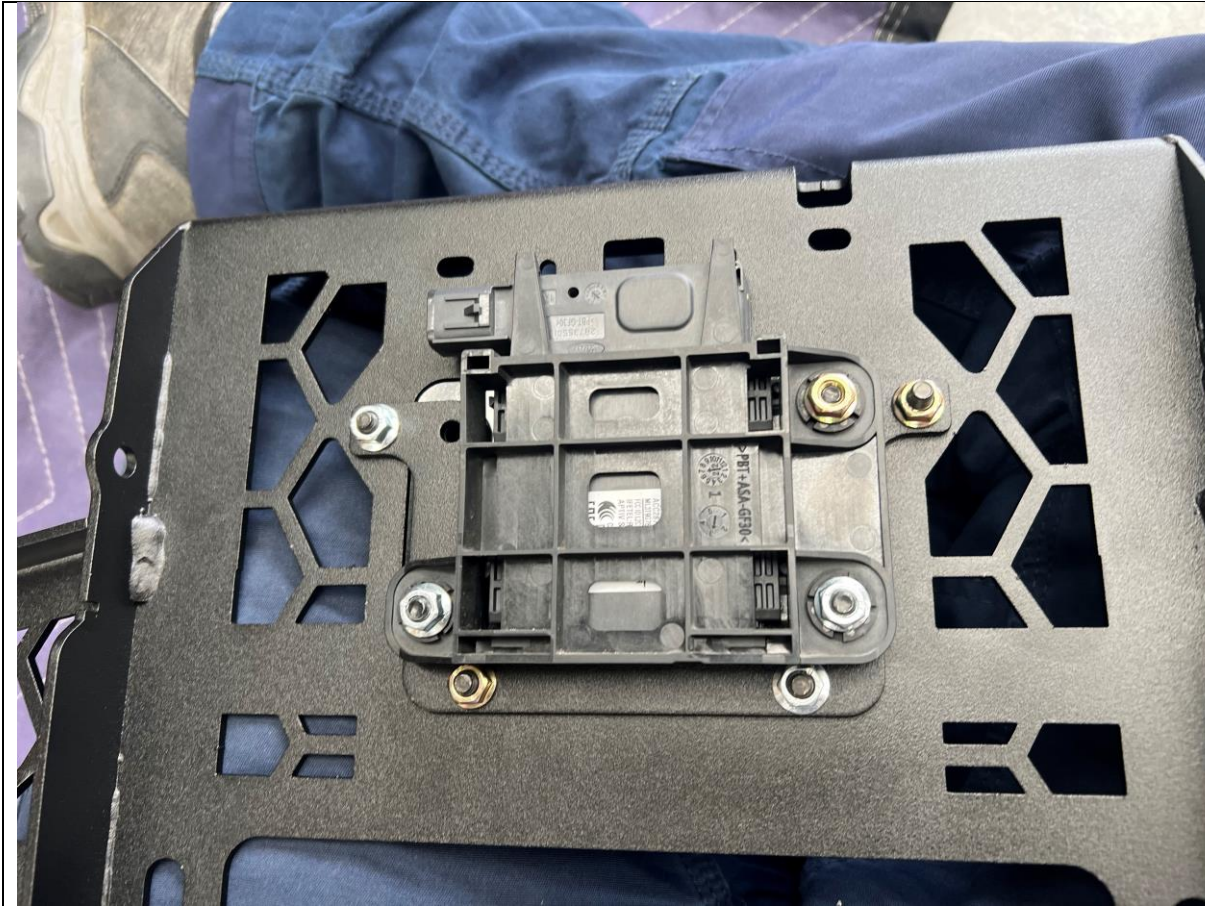

136. Fit the radar module on the support bracket to the main fairlead mesh panel using M6x16 Button head bolts, Flat washers, and flange nuts.
137. Fit M6x16 Button head, Flat washer and flange nut to final hole securing cover panel to radar bracket.

TOOLS REQUIRED

10mm Spanner
4mm Hex Key

FASTENERS

5x M6x30 Button Head
5x M6 Flange Nut
5xM6 Flat Washer

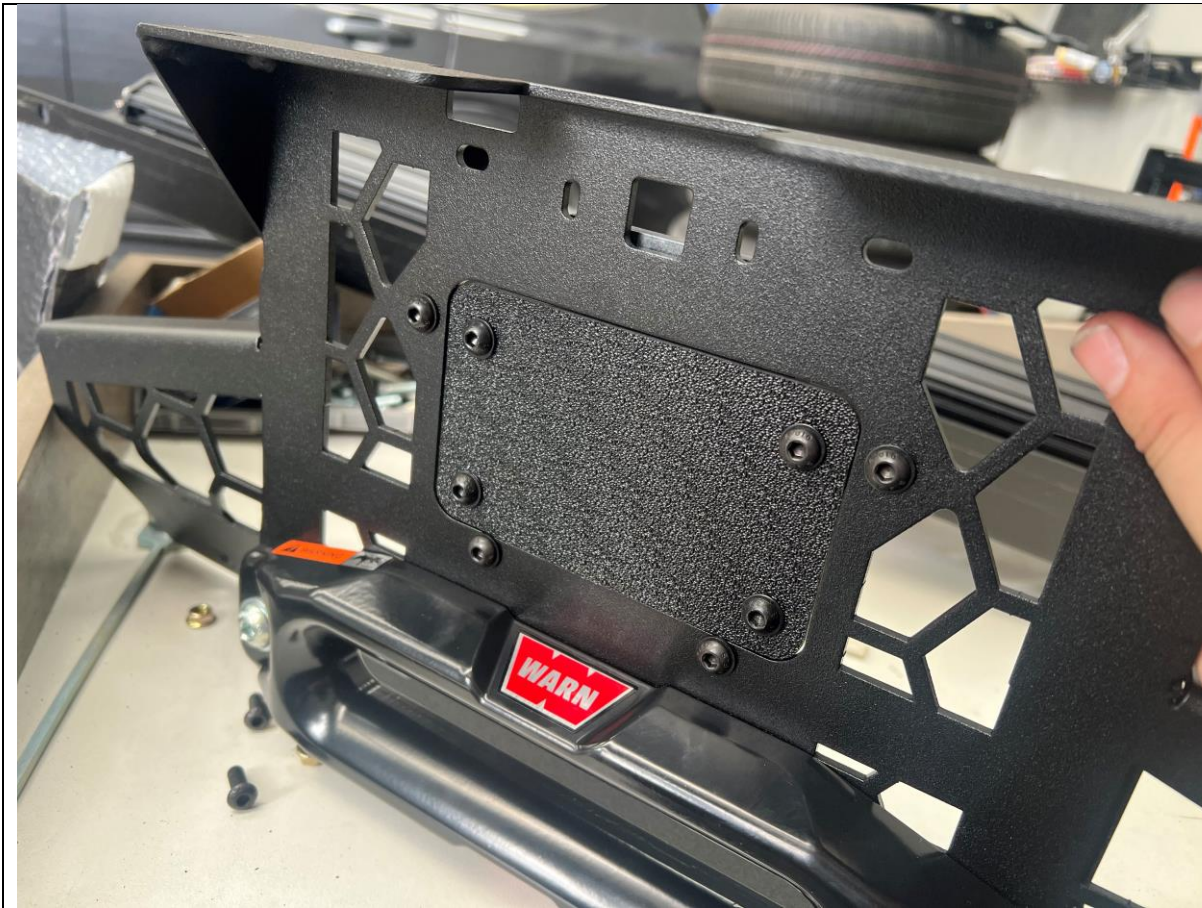

138. If Required, Fit winch fairlead to Mesh Fairlead Mount Use M10 or 3/8" Fasteners supplied with winch. The bar is only compatible with Hawse type fairleads.

139. Fit Number plate flip bracket to fairlead mount, M8x25 Bolt, Flat washer, Nylon washer and Nylon Lock nut. Ensure nylon washer sits between the bracket and fairlead mount.

140. If Relocating Front Camera – Refit camera to mesh panel at this stage – Refer to Camera Relocation Kit instructions

TOOLS REQUIRED

13mm Spanner
10mm Spanner
4mm Hex Key

FASTENERS

2x M8x16 Button Head
2x M8x20 Hex Head
2x M8 Flange Nut
4xM8 Flat Washer

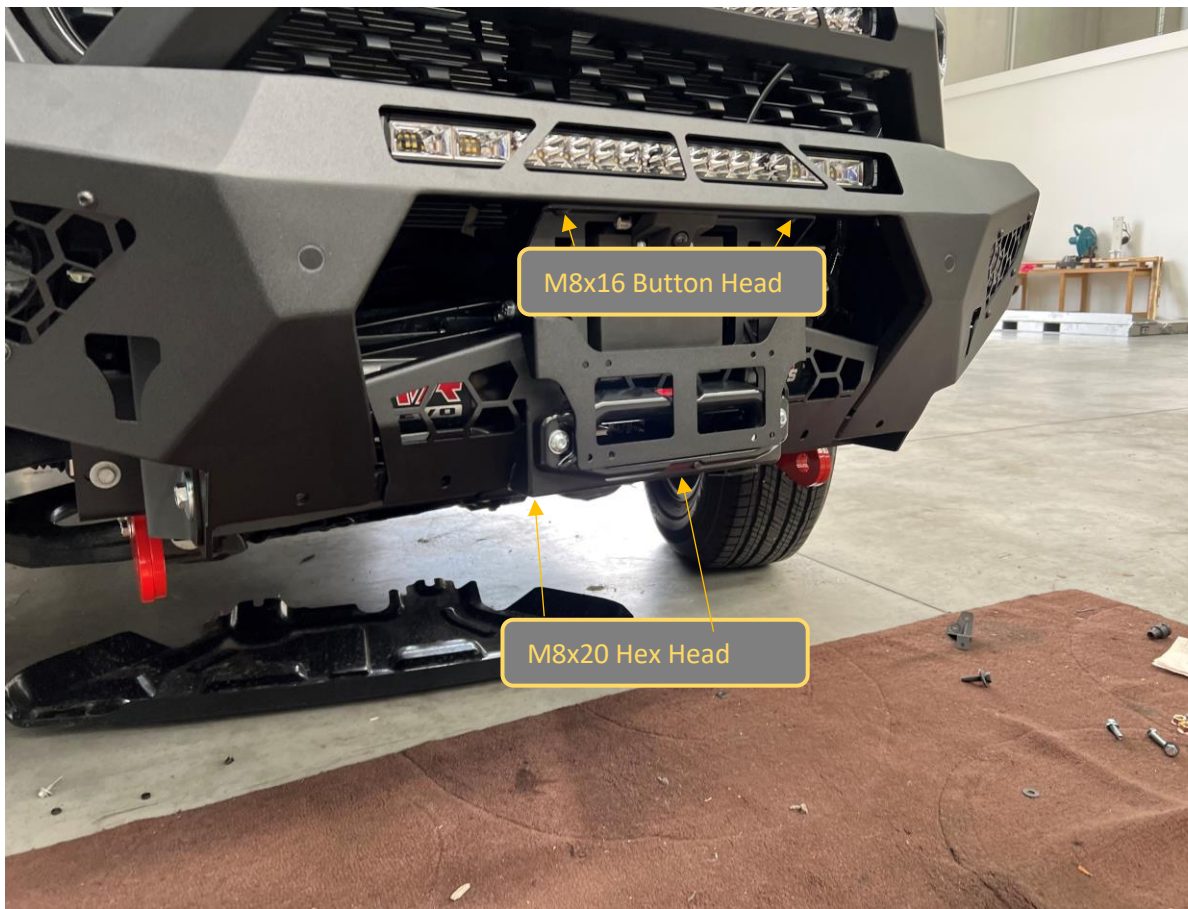

141. Fit the Mesh Fairlead Mount to the center of the bar, using M8x16 Button head (Top), M8x20 Hex (Bottom) M8 Flat washers and M8 Flange Nuts (Bottom Only).
142. Tighten fasteners using 13mm socket / spanner and 5mm Allen Wrench.

TOOLS REQUIRED

13mm Spanner
5mm Allen Wrench

FASTENERS

2x M8x16 Button Head
2x M8x20 Hex Head
2x M8 Flange Nut
4xM8 Flat Washer



143. Re Connect Electrical Harness, camera plug and camera washer hose.

144. Replace upper radiator cowl using original clips.

TOOLS REQUIRED

FASTENERS

Factory clips (re-use)



145. Connect the indicator wiring connectors fitted earlier.
146. Test indicators using the hazard lamp function.

TOOLS REQUIRED

FASTENERS



<p>147. Fit Center Bash Plate using, M8x20 button head, flat washers.</p> <p>148. Secure back of Center Bash Plate using supplied M10x25 Button head, backed by a supplied M10 Flange Nut.</p>	<p>TOOLS REQUIRED</p> <p>10, 13 mm Spanner 5 mm Allen Wrench</p>
<p>149. Tighten Bottom fasteners using 6mm Hex key</p> <p>150. Tighten front fasteners using 5mm Hex key.</p>	<p>FASTENERS</p> <p>4x M8x20 Button Head 4xM8 Flat Washer 2x M10x25 Button Head 2xM10 Flat Washer 2xM10 Flange Nut</p>

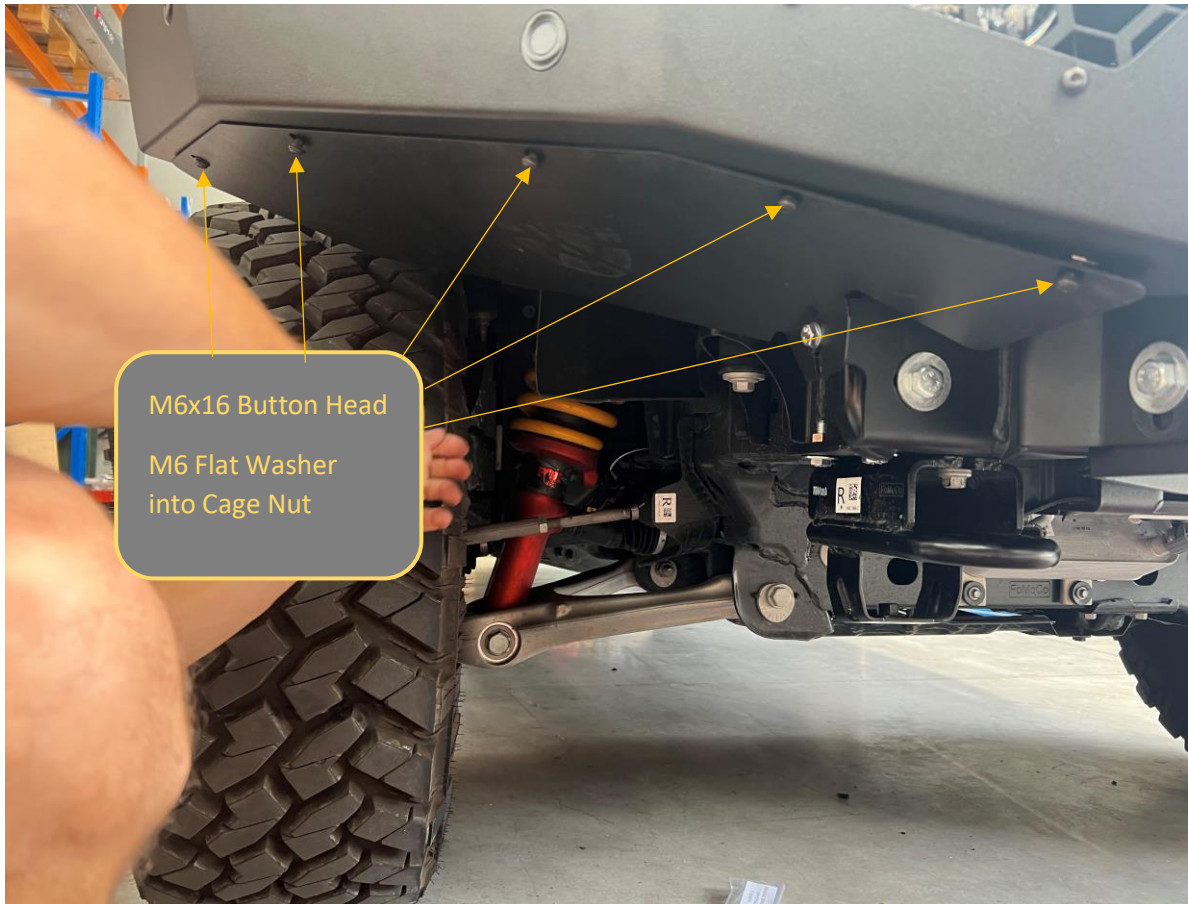

151. Fit Side Under panels using, M6x16 button head and flat washer into the cage nuts placed earlier.
152. Tighten with 4mm Allen wrench
153. Secure back of side under panel to tow point using M8x20 Hex Bolt, Flat washer, and M8 Flange Nut.
154. Leave finger Tight at this stage

TOOLS REQUIRED

FASTENERS

- 10x M6x16 Button Head
- 10x M6 Flat Washer
- 2x M8x25 Hex Head
- 2x M8 Flange Nut
- 2x M8 Flat Washer

TORO BARS ONLY



- 155. If required, fit antenna brackets to the threaded inserts behind bar upright using M8x20 Button Head bolts and Flat Washers.
- 156. Tighten with 5mm Allen wrench
- 157. Fit Antenna As required.
- 158. If not fitting antenna brackets retain and supply to customer for future use, Fit M8x20 Button head bolts and washers to holes to preserve threads.

TOOLS REQUIRED

FASTENERS

2x M8x20 Button Head Bolt
2xM8 Flat Washer

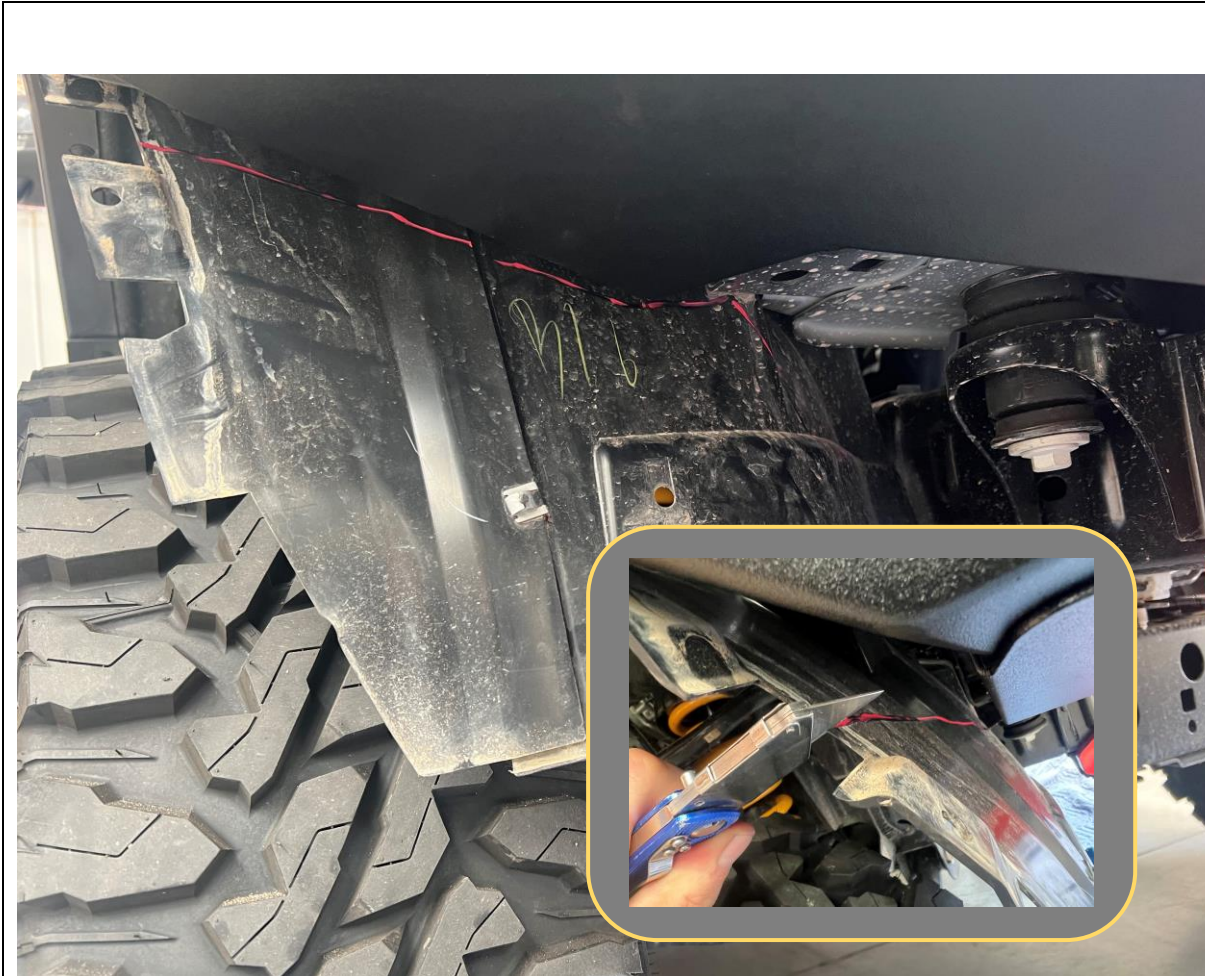

159. Using the edge of the under panel as a guide mark the wheel arch liner, approximately 15mm beyond the intersection of the under panel.
160. Cut along line as marked using utility Knife
161. Tuck the wheel arch liner behind the flange on the under panel
162. Tighten all under panel bolts
163. Complete for other side of vehicle.

TOOLS REQUIRED
Utility Knife
13mm Spanner
5mm Allen Wrench
4mm Allen Wrench

FASTENERS



164. Check all Fasteners are tight.
165. **If Relocating Front Camera – Complete camera relocation steps - Refer to Camera Relocation Kit instructions**
166. Re-Fit number plate to number plate flip.
167. Head Bush and Enjoy your newly protected Ranger or Everest!

For contact details see www.offroadanimal.com