

**ISUZU D-MAX RG
MY2024 FACELIFT
PREDATOR & TORO FRONT BAR**



IMPORTANT! – READ BEFORE INSTALLATION





- When installed in accordance with these instructions, the front protection bar does not affect the operation of the vehicle's SRS airbags.
- This product must be installed exactly as per these instructions using only hardware supplied.
- Take a few moments to read instructions thoroughly before beginning work.
- In the event of damage to any bar component please contact OFFROAD ANIMAL to arrange repair/replacement of components.
- Do not use this product for any vehicle make or model other than that specified on these instructions.
- Do not remove labels from this product.
- This product and its fixings must not be modified in any way unless stated in these fitting instructions.
- The installation of this product is recommended for trained personnel.
- These instructions are correct at time of publication. OFFROAD ANIMAL cannot be held responsible for the impact of any changes subsequently made by the vehicle manufacturer. If you find something has changed please contact us to let us know!
- During installation it is the duty of the installer to check correct operation/clearances of all components.
- If Instructions are to be printed for reference in the workshop, it is recommended that they are printed in colour, for best legibility.

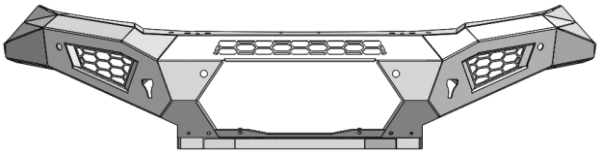
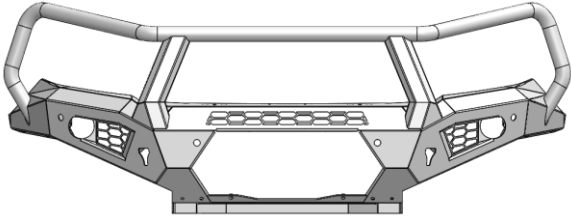

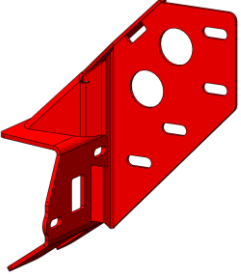
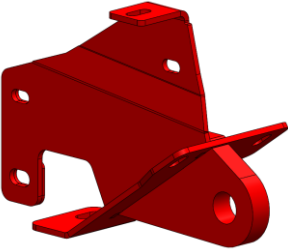
PARTS LISTING

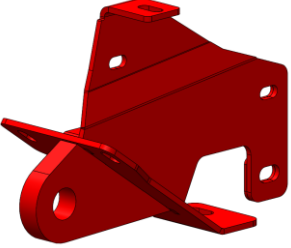
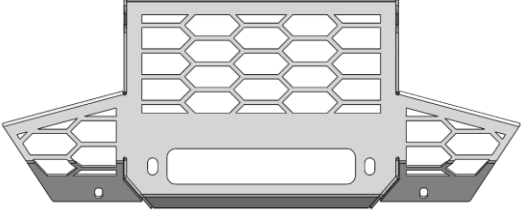
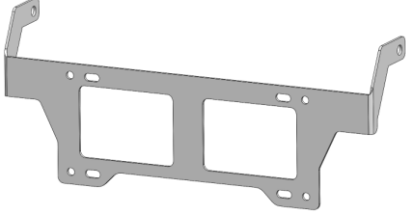
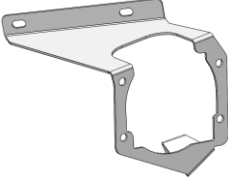
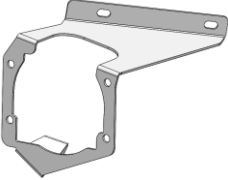

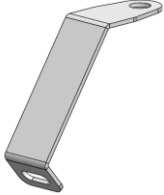
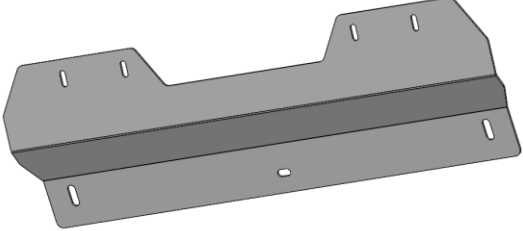
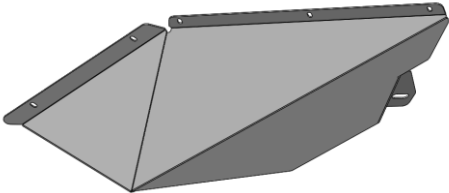
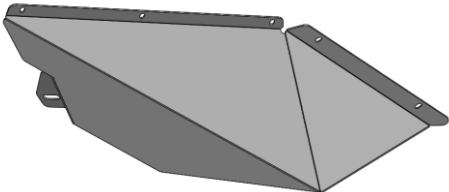
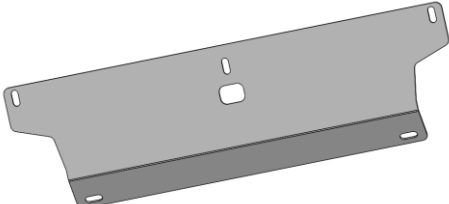

IMPORTANT: Check all parts are present before beginning work! Contact OFFROAD ANIMAL if something is missing.

Main Parts – In the Box

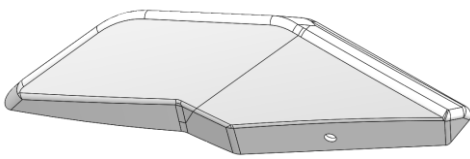
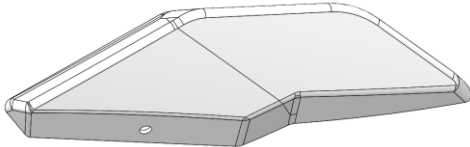
Qty	Part Number	Description	Image
1	FB-IDM-RG-24-PR-ASM1	D-MAX MY24 Facelift Predator Bar Welded Assy	
OR			
1	FB-IDM-RG-24-TOR-ASM1	D-MAX MY24 Facelift Toro Bar Welded Assy	
1	FB-IDM-RG-21-PR-ASM2R	ISUZU DMAX 21+ IMPACT ASSY RH	
1	FB-IDM-RG-21-PR-ASM2L	ISUZU DMAX 21+ IMPACT ASSY LH	
1	FB-IDM-RG-21-PR-ASM3R	ISUZU DMAX 21+ TOW POINT ASSY RH	

<p>1</p>	<p>FB-IDM-RG-21-PR-ASM3L</p>	<p>ISUZU DMAX 21+ TOW POINT ASSY LH</p>	
<p>1</p>	<p>FB-IDM-RG-24-PR-ASM2</p>	<p>D-MAX MY24 Facelift Mesh Fairlead Welded Assembly</p>	
<p>1</p>	<p>B-0822</p>	<p>WL Predator Number Plate Bracket</p>	
<p>1</p>	<p>B-1286R</p>	<p>D-MAX MY24 Facelift Fog Light Bracket RH</p>	
<p>1</p>	<p>B-1286L</p>	<p>D-MAX MY24 Facelift Fog Light Bracket LH</p>	
<p>1</p>	<p>B-1287</p>	<p>D-MAX MY24 Facelift Pan Brace</p>	
<p>1</p>	<p>B-1293R</p>	<p>D-MAX RG Headlight Corner Infill Bracket RH</p>	
<p>1</p>	<p>B-1293L</p>	<p>D-MAX RG Headlight Corner Infill Bracket LH</p>	

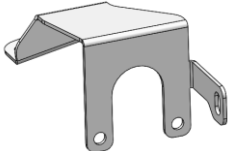
<p>2</p>	<p>B-1296</p>	<p>D-MAX MY24 Facelift Grille Infill Brace</p>	
<p>1</p>	<p>U-0036</p>	<p>Isuzu DMAX 2021+ Predator Bash Plate</p>	
<p>1</p>	<p>U-0037R</p>	<p>Isuzu DMAX 2021+ Predator Side Underpanel RH</p>	
<p>1</p>	<p>U-0037L</p>	<p>Isuzu DMAX 2021+ Predator Side Underpanel LH</p>	
<p>1</p>	<p>U-0041</p>	<p>DMAX 21+ Supplementary Underpanel</p>	
<p>4</p>	<p>CPHP035</p>	<p>Plastic Hole Insert, 22MM, Black, Tigerlink Hardware CPHP035</p>	
<p>1</p>	<p>F-0031R</p>	<p>D-MAX MY24 Facelift Grille Infill RH</p>	
<p>1</p>	<p>F-0031L</p>	<p>D-MAX MY24 Facelift Grille Infill LH</p>	

1	FB-IDM-RG-21-PR-ADRCP	ADR Compliance Plate DMAX 21+	
1	OFA-LOGO	Offroad Animal Metal Logo	
1	FI Note	Fitting Instruction Note	N/A
1	TK-FB-IDM-RG-24	Tape Kit - D-MAX 24+, 3M5952, 2x 30x6mm, 2x 50x6mm, 2x 75x15mm	N/A
2	PWS-SIDE-275	Pinch Weld PWS53S - Side Bulb Seal 275mm	N/A
TORO ONLY			
2	B-1244	Toro Antenna Bracket - Tall 8deg	
1	B-1292R	D-MAX MY24 Facelift Toro Indicator Bracket RH	
1	B-1292L	D-MAX MY24 Facelift Toro Indicator Bracket LH	
2	LED Autolamps 80AW	LED AUTOLAMPS 80AW LED INDICATOR PARKER COMBO LIGHT, SINGLE BLISTER PACK	

PREDATOR Fasteners – Contained in Small Parts Kit Bag

Qty	Part Number	Description
35	M6x16 BHCS BLACK ZINC	SCREW, BUTTON HEAD CAP, M6X16X1 GR12.9, ISO4042 ZnNi BLACK PASSIVATED FINISH
35	M6 FLAT WASHER BLACK ZINC	M6 Flat Washer, 12x6.1x1, ISO4042 ZnNi BLACK PASSIVATED FINISH
16	M6 FLANGE NUT	Flange Nut, M6x1 G8.8 ZP
10	M6CN3MM	CAGE NUT M6x2.6-3.5
2	M8 X 20 HEX	Bolt Hex, M8X20x1.25, GR8.8 ZP
2	M8 X 16 BHCS BZP	SCREW, BUTTON HEAD CAP, M8X16X1.25 GR12.9, ISO4042 ZnNi BLACK PASSIVATED FINISH
6	M8 X 25 BHCS BLACK ZINC	SCREW, BUTTON HEAD CAP, M8X25X1.25, ISO4042 ZnNi BLACK PASSIVATED FINISH
4	M8 HD FLAT WASHER	M8 FLAT WASHER - High Tensile 19x8x1.9mm
8	M8 HD FLAT WASHER - BZP	M8 FLAT WASHER - High Tensile 19x8x2mm, ISO4042 ZnNi BLACK PASSIVATED FINISH
2	M8 NYW	Washer, M8, Nylon
2	M8 NYLOC	NYLOC SELF LOCKING NUT, ST STL A2 ISO
11	M10 x 30	Bolt Hex, M10X30x[1.5], GR8.8 ZP
11	M10 FW LHD	WASHER, FLAT M10X28.5X2.5
7	M10 FLANGE NUT	Flange Nut, M10x1.5 G8.8 ZP
12	M12X30	Bolt Hex, M12X30x1.75, GR8.8 ZP
14	M12 FW LHD	M12 FW Large Heavy Duty
8	M12 FLANGE NUT	Flange Nut, M12x1.75 G8.8 ZP
2	M12 Nyloc nut	M12 NYLOC NUT
2	FB-IDM-RG-21-PR-ASM4	DMAX 21+ Tow Point Nut Plate
2	NP-COM-M10-190-ASM0	M10 LOLLYPOP NUT PLATE 190MM LONG

TORO Fasteners – Contained in Small Parts Kit Bag

Qty	Part Number	Description
41	M6x16 BHCS BLACK ZINC	SCREW, BUTTON HEAD CAP, M6X16X1 GR12.9, ISO4042 ZnNi BLACK PASSIVATED FINISH
41	M6 FLAT WASHER BLACK ZINC	M6 Flat Washer, 12x6.1x1, ISO4042 ZnNi BLACK PASSIVATED FINISH
22	M6 FLANGE NUT	Flange Nut, M6x1 G8.8 ZP
10	M6CN3MM	CAGE NUT M6x2.6-3.5
2	M8 X 20 HEX	Bolt Hex, M8X20x1.25, GR8.8 ZP
2	M8 X 16 BHCS BZP	SCREW, BUTTON HEAD CAP, M8X16X1.25 GR12.9, ISO4042 ZnNi BLACK PASSIVATED FINISH
10	M8 X 25 BHCS BLACK ZINC	SCREW, BUTTON HEAD CAP, M8X25X1.25, ISO4042 ZnNi BLACK PASSIVATED FINISH
4	M8 HD FLAT WASHER	M8 FLAT WASHER - High Tensile 19x8x1.9mm
4	M8 FLAT WASHER- BLACK ZINC	M8 FLAT WASHER, 16.5x8.4x1.2, ISO4042 ZnNi BLACK PASSIVATED FINISH
8	M8 HD FLAT WASHER - BZP	M8 FLAT WASHER - High Tensile 19x8x2mm, ISO4042 ZnNi BLACK PASSIVATED FINISH
2	M8 NYW	Washer, M8, Nylon
2	M8 NYLOC	NYLOC SELF LOCKING NUT, ST STL A2 ISO
11	M10 x 30	Bolt Hex, M10X30x[1.5], GR8.8 ZP
11	M10 FW LHD	WASHER, FLAT M10X28.5X2.5
7	M10 FLANGE NUT	Flange Nut, M10x1.5 G8.8 ZP
12	M12X30	Bolt Hex, M12X30x1.75, GR8.8 ZP
14	M12 FW LHD	M12 FW Large Heavy Duty
8	M12 FLANGE NUT	Flange Nut, M12x1.75 G8.8 ZP
2	M12 Nyloc nut	M12 NYLOC NUT
2	FB-IDM-RG-21-PR-ASM4	DMAX 21+ Tow Point Nut Plate
2	NP-COM-M10-190-ASM0	M10 LOLLYPOP NUT PLATE 190MM LONG

TOOLS REQUIRED

The following tools will be required to install the product.

Hand Tools	Power Tools	Workshop Equipment
Metric Socket Set 10-19mm	Electric/Air Impact Driver (Optional)	Panel stand or Soft Blanket
Socket Extension Bar	Soldering Iron	Lifting Trolley
Metric Spanner Set 10-19mm	Air hacksaw or Jigsaw	Isopropyl Alcohol
Hex (Allen) Key Set 4-6mm	Multi-tool or Angle grinder	Rag
Trim Removal Tool		Cable Ties
Plastic Auto Trim Tool Set		Marker pen
Flat Blade Screwdriver Set		Ruler
Phillips Head Screwdriver Set		Measuring tape
Utility Knife		Masking tape
Side Cutters		Electrical tape
Pliers		Heat shrink
Wire Strippers		

WORKSHOP SAFETY

It is the responsibility of the installer to always complete works in a safe manner. Make sure the following safety equipment is available and precautions are observed whilst fitting this product.

<p>Hearing Protection</p> 	<p>Always wear ear protection when using power tools.</p>
<p>Eye Protection</p> 	<p>Ensure eye protection is always worn when cutting or drilling.</p>
<p>Manual Handling</p> 	<p>Do not attempt to lift bar assemblies or rock sliders on your own.</p> <p>Always use two people to lift or use mechanical lifting aid such as hydraulic lifting trolley.</p>
<p>Vehicle Support</p> 	<p>Always ensure vehicle is properly supported when working on it. Do not attempt to fit products whilst suspension work is being carried out. Do not work under a vehicle supported only by a jack.</p>



1. Remove number plate from bumper and set aside.

TOOLS REQUIRED

Phillips head screwdriver

FASTENERS



<ol style="list-style-type: none"> 2. Open the Bonnet. 3. Remove 2x plastic push clips holding the factory air intake scoop. To remove each push clip, lever the centre section upwards using a flat blade screwdriver or trim tool, as shown. Retain these clips. 	<p style="text-align: center;">TOOLS REQUIRED</p> <p style="text-align: center;">Flat blade screwdriver or Trim tool</p>
<ol style="list-style-type: none"> 4. Remove the factory air intake scoop and set aside. Take care not to drop anything into the intake. 	<p style="text-align: center;">FASTENERS</p> <p style="text-align: center;">2x plastic push clips</p>

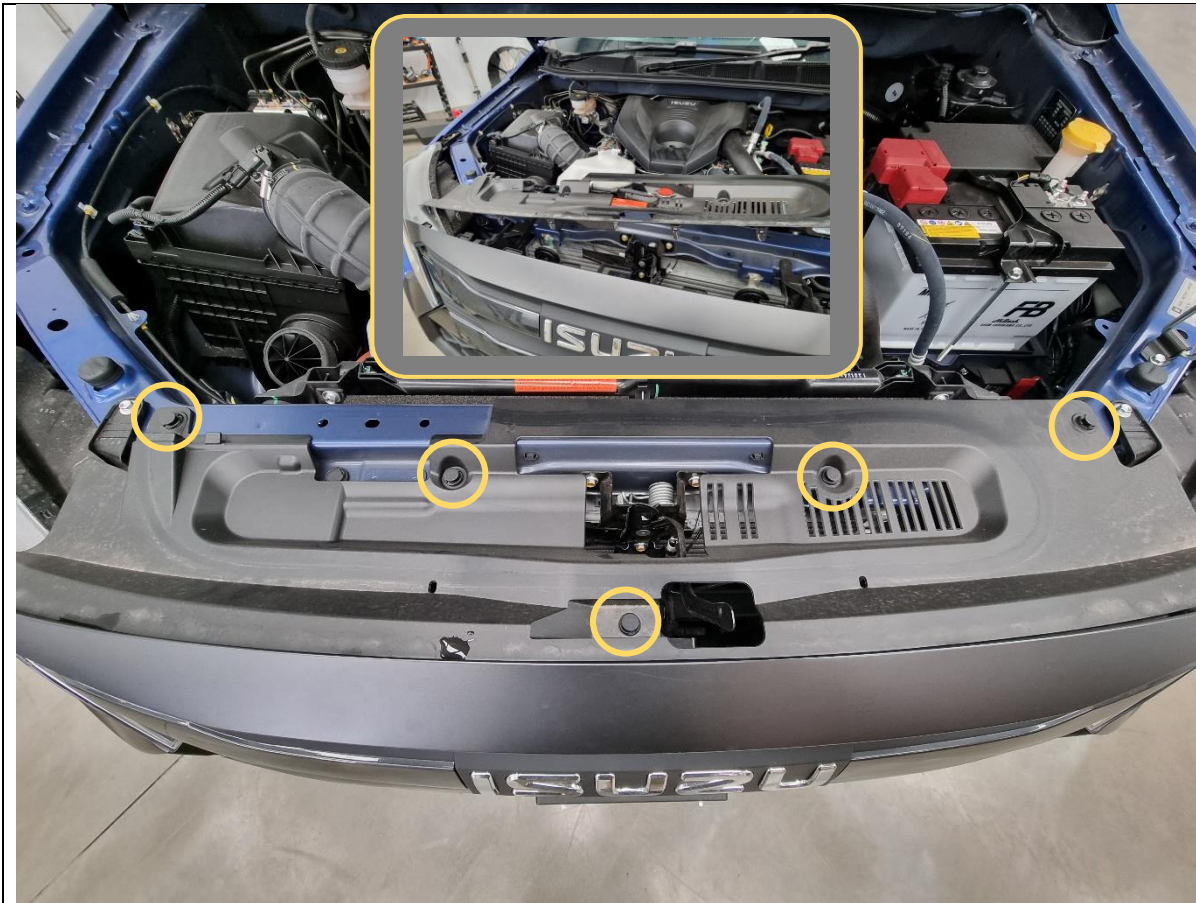

5. Remove 5x plastic push clips holding the radiator grille cover. Retain these clips.
6. Pull upwards to remove the radiator grille cover and set aside.

TOOLS REQUIRED

Flat blade screwdriver
or
Trim tool

FASTENERS

5x plastic push clips



7. Remove 6x plastic push clips holding the grille. There are 2x clips on the top edge, and 4x clips on the cross member on the inside of the grille.

TOOLS REQUIRED

Flat blade screwdriver
or
Trim tool

FASTENERS

6x plastic push clips



<p>8. On each side of the vehicle, remove 1x plastic push clip holding the end corner of the bumper to the quarter panel.</p> <p>9. On each side at the bottom of the front wheel arch liner, remove 1x plastic push clip holding the bottom of the bumper to the outer support bracket (see bottom left inset).</p>	<p>TOOLS REQUIRED</p> <p>Flat blade screwdriver or Trim tool</p>
	<p>FASTENERS</p> <p>4x plastic push clips</p>



10. On the underside of the bumper, remove 2x plastic push clips holding the bumper to the inner support brackets. These are located near where the factory tie down hooks are.
11. On the underside of the bumper, remove 2x 10mm flange nuts holding the bumper to the wheel arch liner.

TOOLS REQUIRED

- Flat blade screwdriver
or
Trim tool
- 10mm socket

FASTENERS

- 2x plastic push clips
- 2x factory 10mm flange nuts



<p>12. Release the bumper clips by pulling the bumper away and outwards from outer corners, starting from the outside and working in.</p> <p>13. When bumper is loose, reach in and disconnect the bumper harness connectors (either 1x or 2x) located under the left-hand headlight.</p> <p>14. Fully remove the bumper from car and set aside.</p>	<p>TOOLS REQUIRED</p>
	<p>FASTENERS</p>

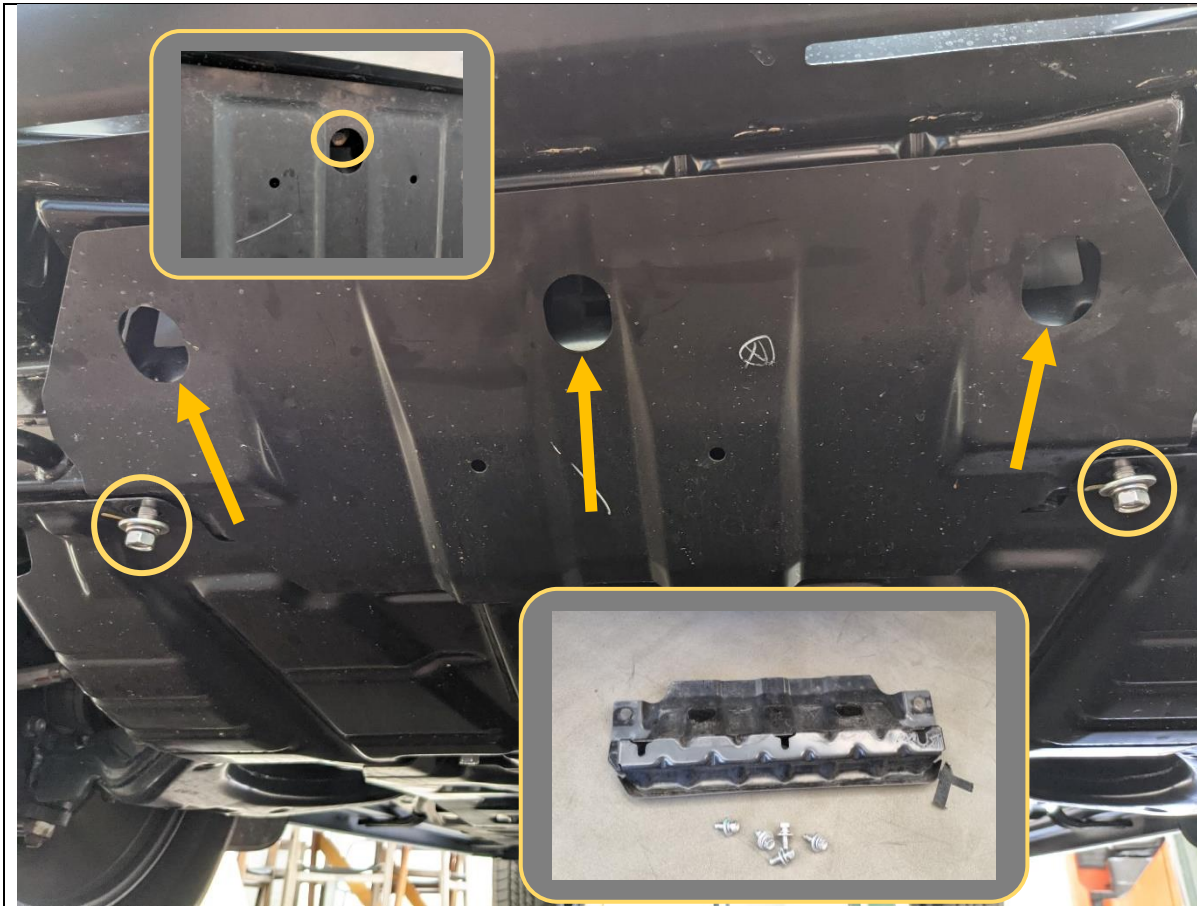

15. Remove the front skid plate by removing the 5x 14mm hex bolts securing it to the chassis. Retain the bolts for use later.

Note 3x bolts are recessed into the skid plate, as shown with arrows.

TOOLS REQUIRED

14mm socket
Socket extension bar

FASTENERS

5x factory 14mm hex bolts
Retain for re-fitment

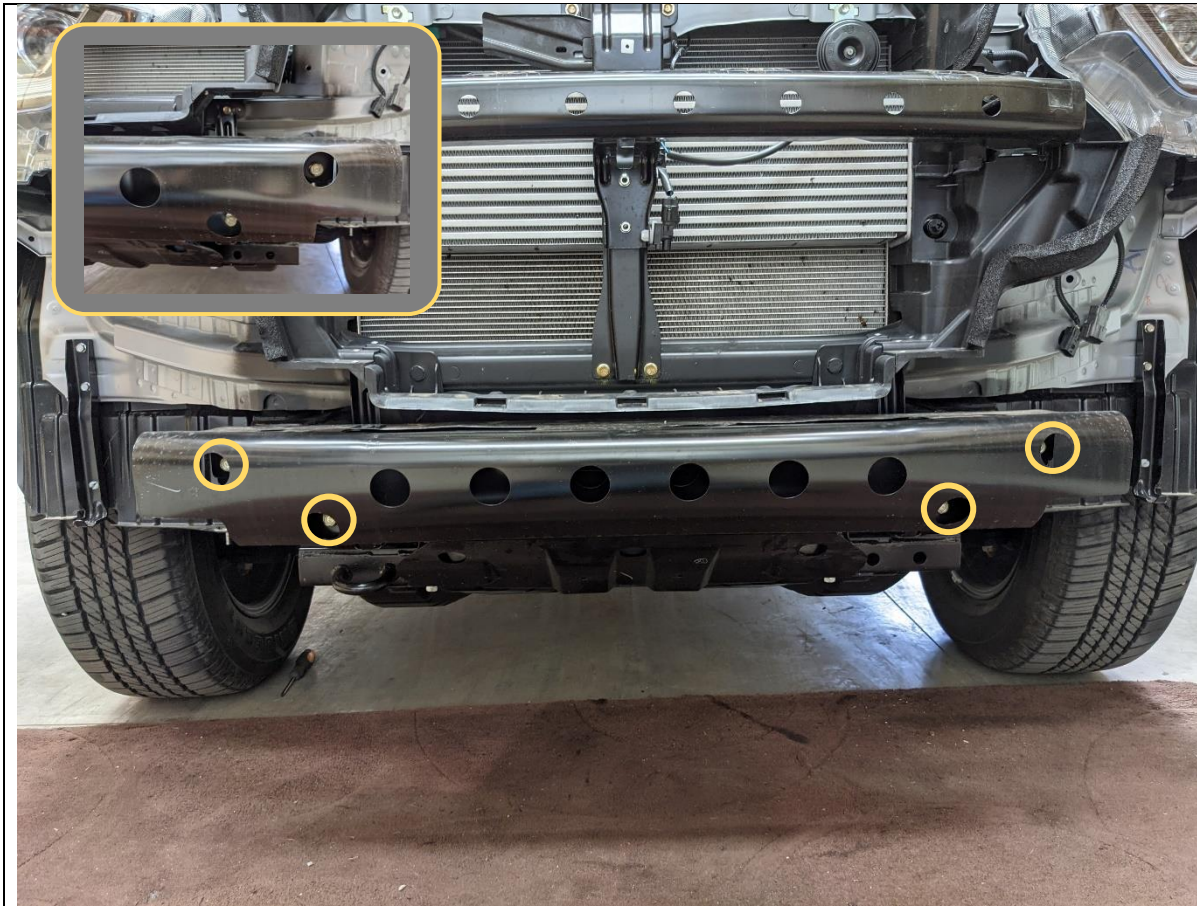

<p>16. Remove the 4x 14mm hex bolts securing the impact beam to the chassis.</p> <p>17. Remove and discard the impact beam. Retain bolts for fitting of mounts.</p>	<p>TOOLS REQUIRED</p> <p>14mm socket</p>
	<p>FASTENERS</p> <p>4x factory 14mm hex bolts</p> <p>Retain for re-fitment</p>

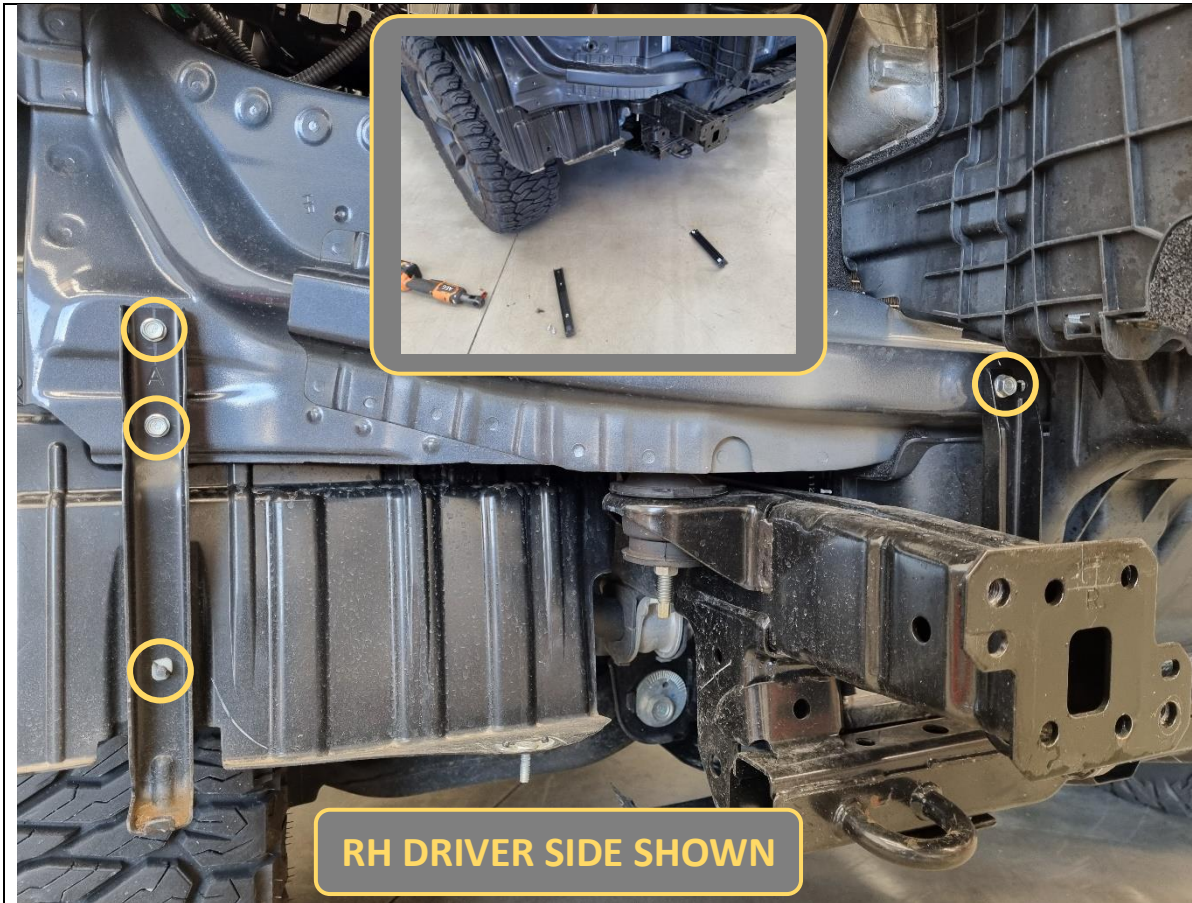

<p>18. Remove the 3x 10mm hex bolts securing each outer bumper support bracket.</p> <p>19. Remove the 1x 10mm hex bolt securing each inner bumper support bracket.</p> <p>20. Remove and discard the bumper supports.</p>	<p>TOOLS REQUIRED</p> <p>10mm socket/spanner</p>
	<p>FASTENERS</p> <p>8x 10mm factory hex bolts</p>

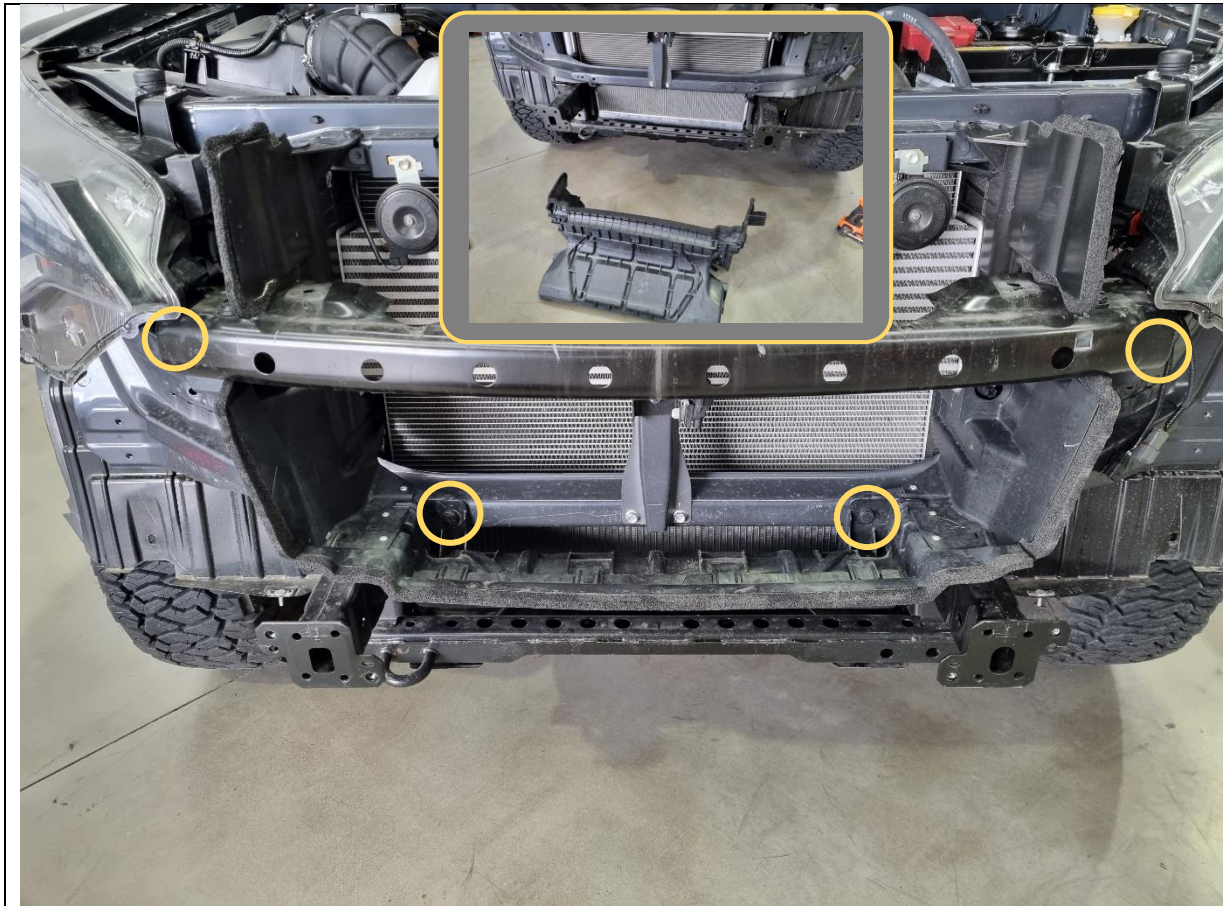

21. Remove the 4x plastic push clips holding the lower plastic air guide.

TOOLS REQUIRED

Flat blade screwdriver
or
Trim tool

FASTENERS

4x plastic push clips

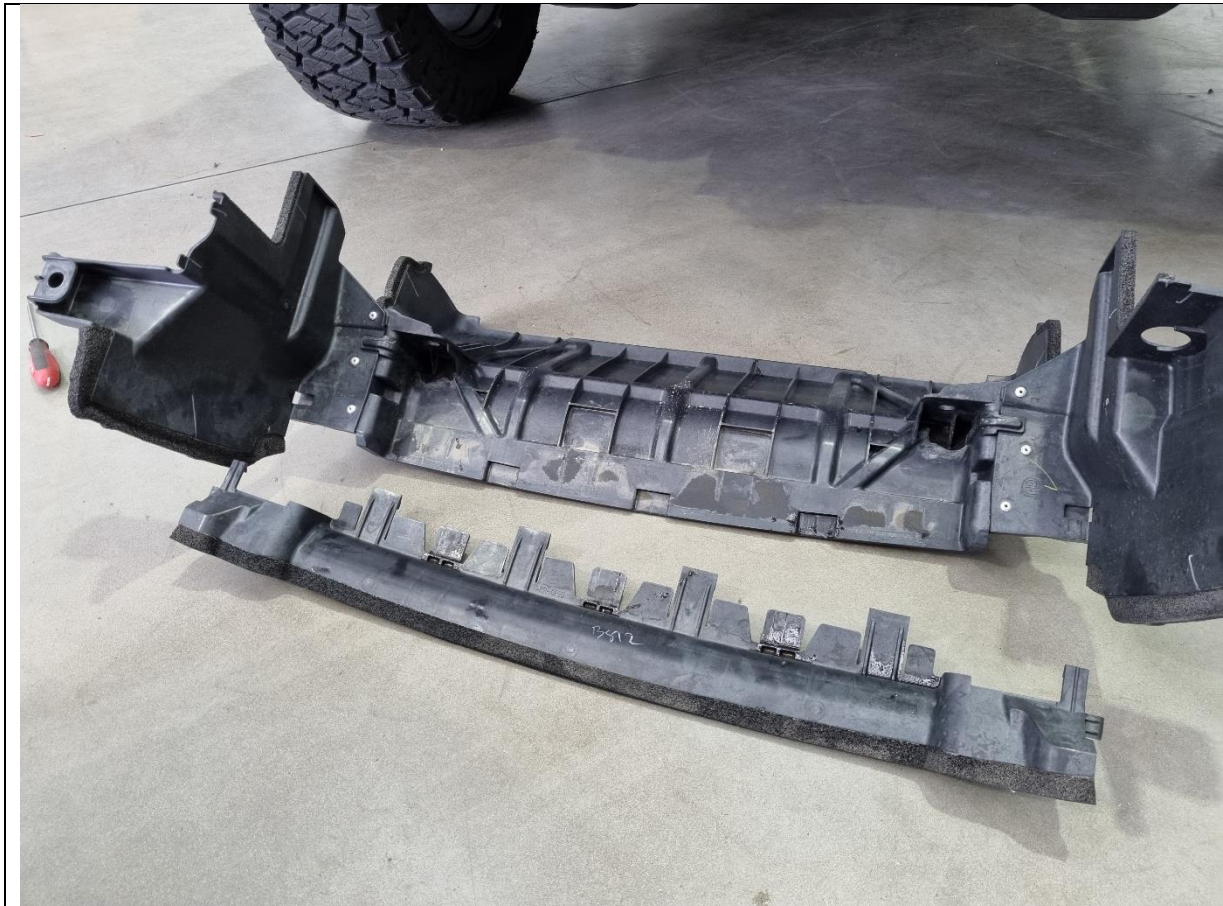

22. Unclip the front plastic lip from the air guide and discard.

TOOLS REQUIRED

FASTENERS

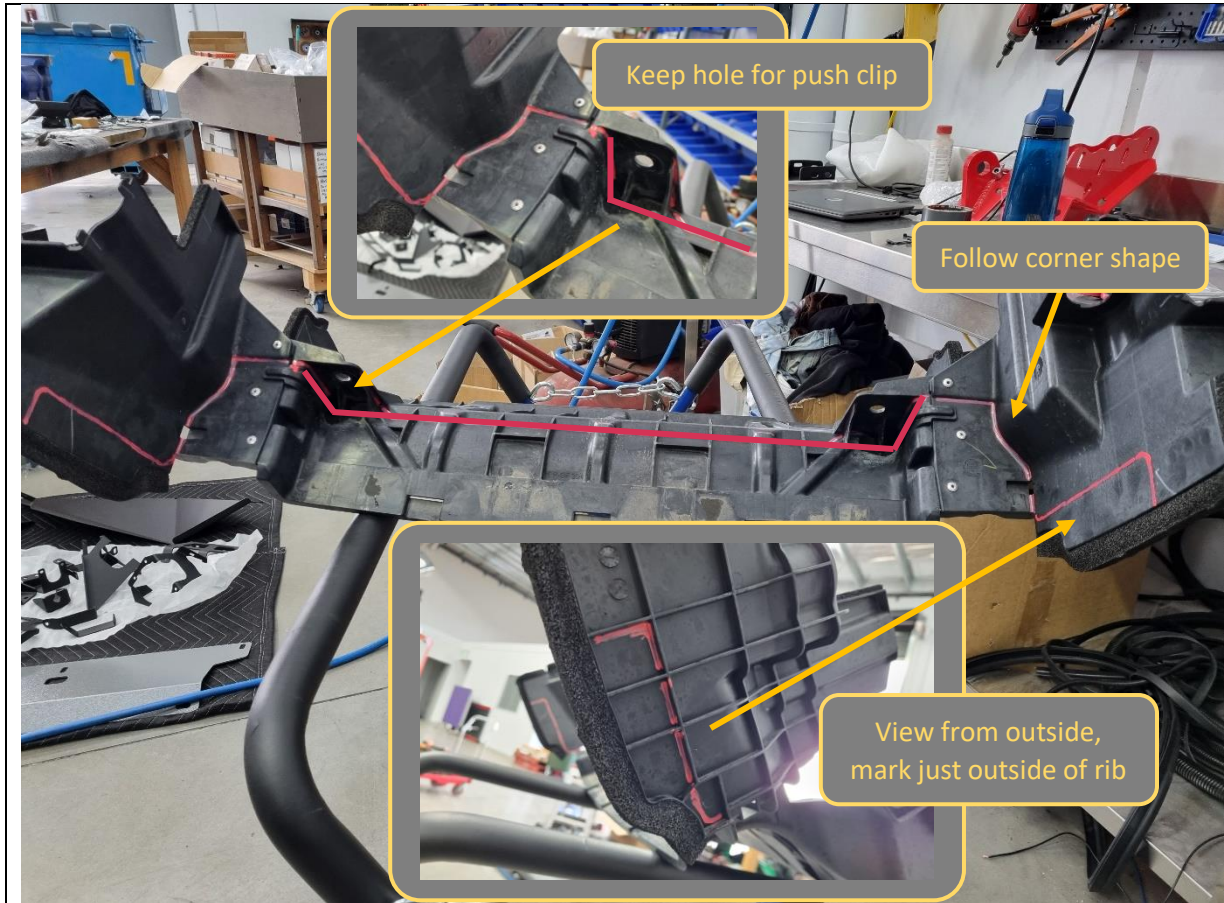

23. Use a marker pen and mark a cut line on the air guide, as shown.

TOOLS REQUIRED

Marker pen

FASTENERS

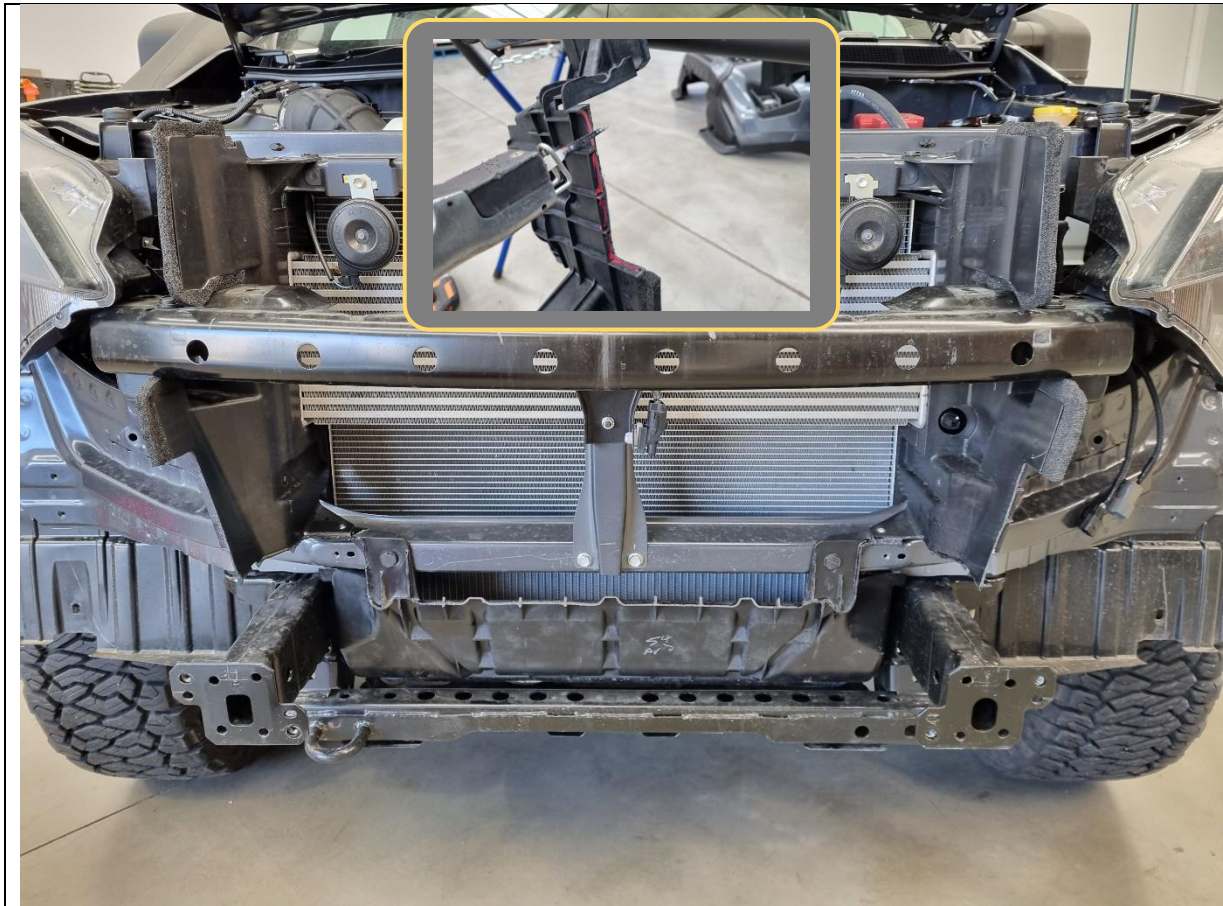

24. Trim the plastic air guide along the marking.

25. Discard the front section, then refit the trimmed air guide back onto the vehicle with the same 4x push clips.

TOOLS REQUIRED

Utility knife
or
air hacksaw

FASTENERS

4x plastic push clips

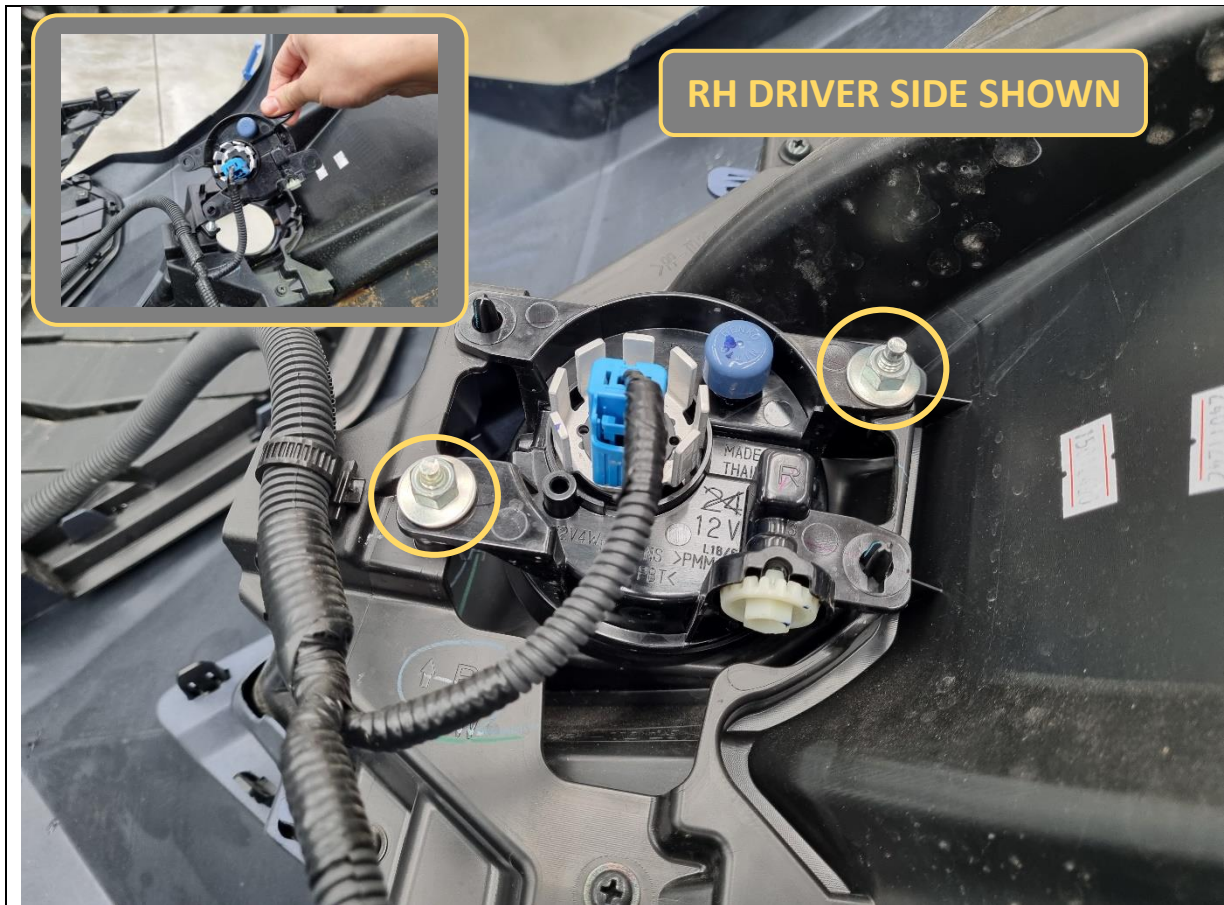

26. If equipped, remove 2x 10mm flange nuts securing each fog light on the back of the bumper.

TOOLS REQUIRED

10mm socket/spanner

FASTENERS

4x 10mm flange nuts



27. If equipped, take note of the orientation of all 4x parking sensors. The plugs should all be pointing outwards to the side of the vehicle.
28. Spread open the tabs on the plastic sensor holder and unclip each parking sensor.
29. Press down on the tabs on the sensor holders and remove them from the bumper. Keep track of the sensor holder orientation.
30. Re-fit the sensor holders back onto the parking sensors in the same original orientation.

TOOLS REQUIRED

FASTENERS

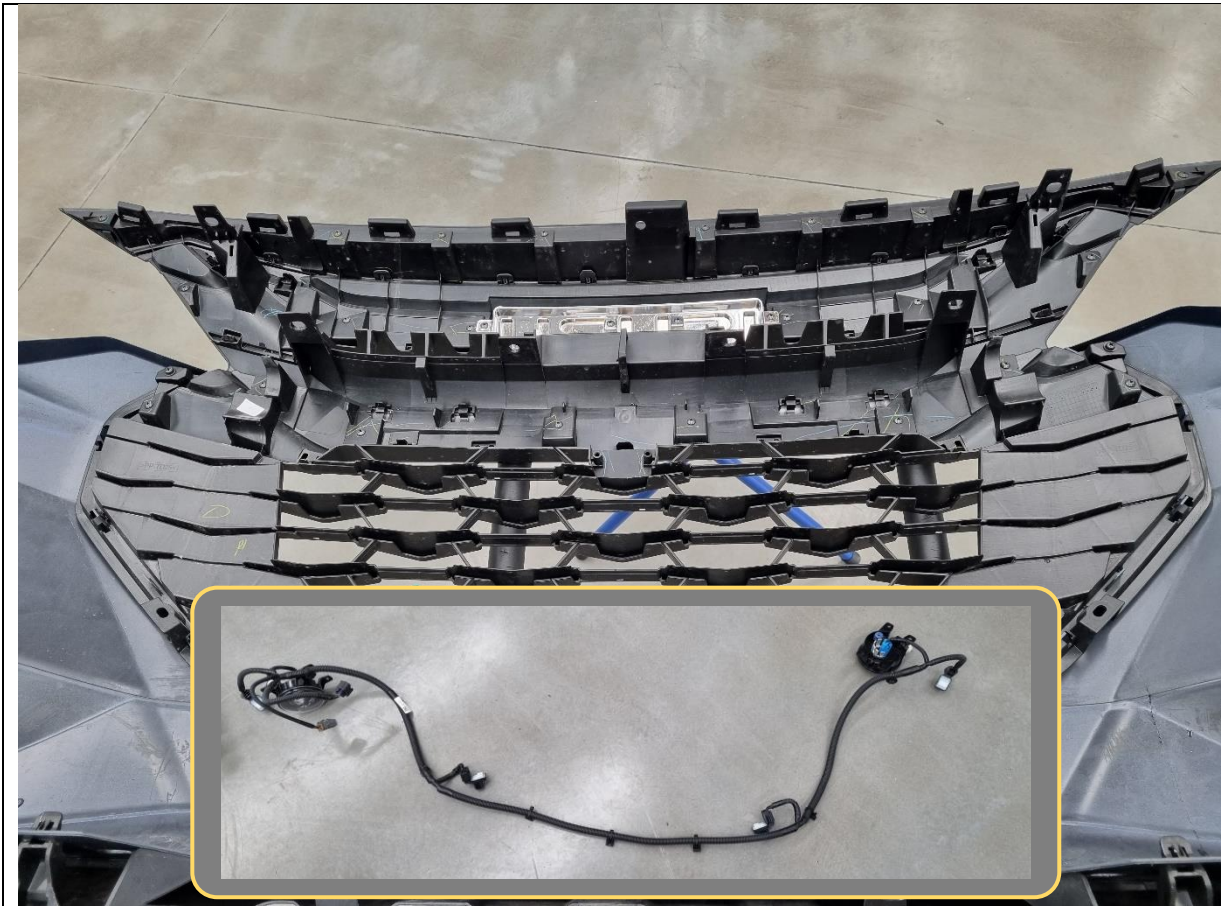

31. Unclip and strip the entire harness from the bumper and set aside.

TOOLS REQUIRED

FASTENERS

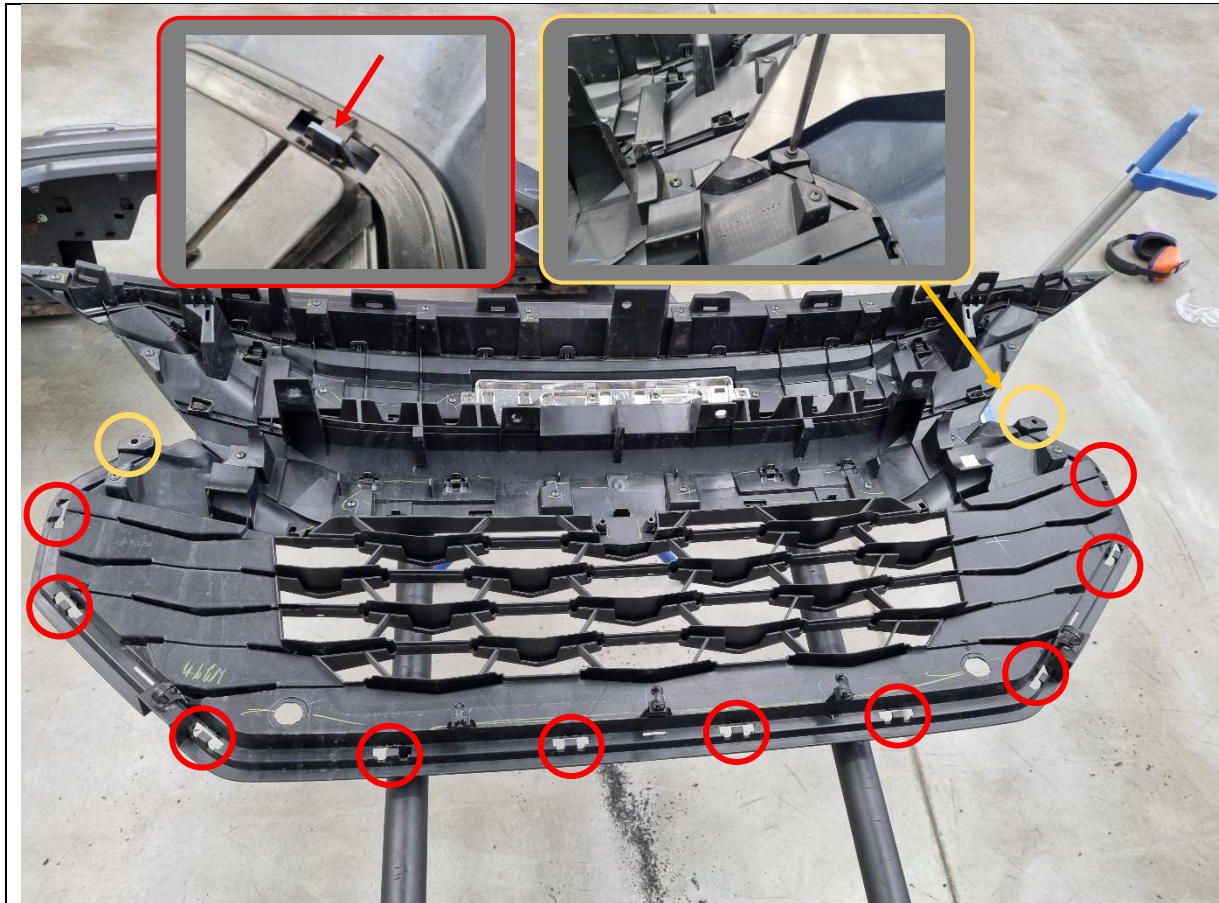

- 32. Remove 2x Phillips head screws securing the back of the grille to the bumper.
- 33. Then use a flat blade screwdriver or similar and release all 10x plastic tabs around the outside of the grille securing it to the bumper.
- 34. Start from one end and work all the way around until the grille is separated. Discard the bumper.

TOOLS REQUIRED

Phillips head screwdriver
Flat blade screwdriver
or
Trim tool

FASTENERS

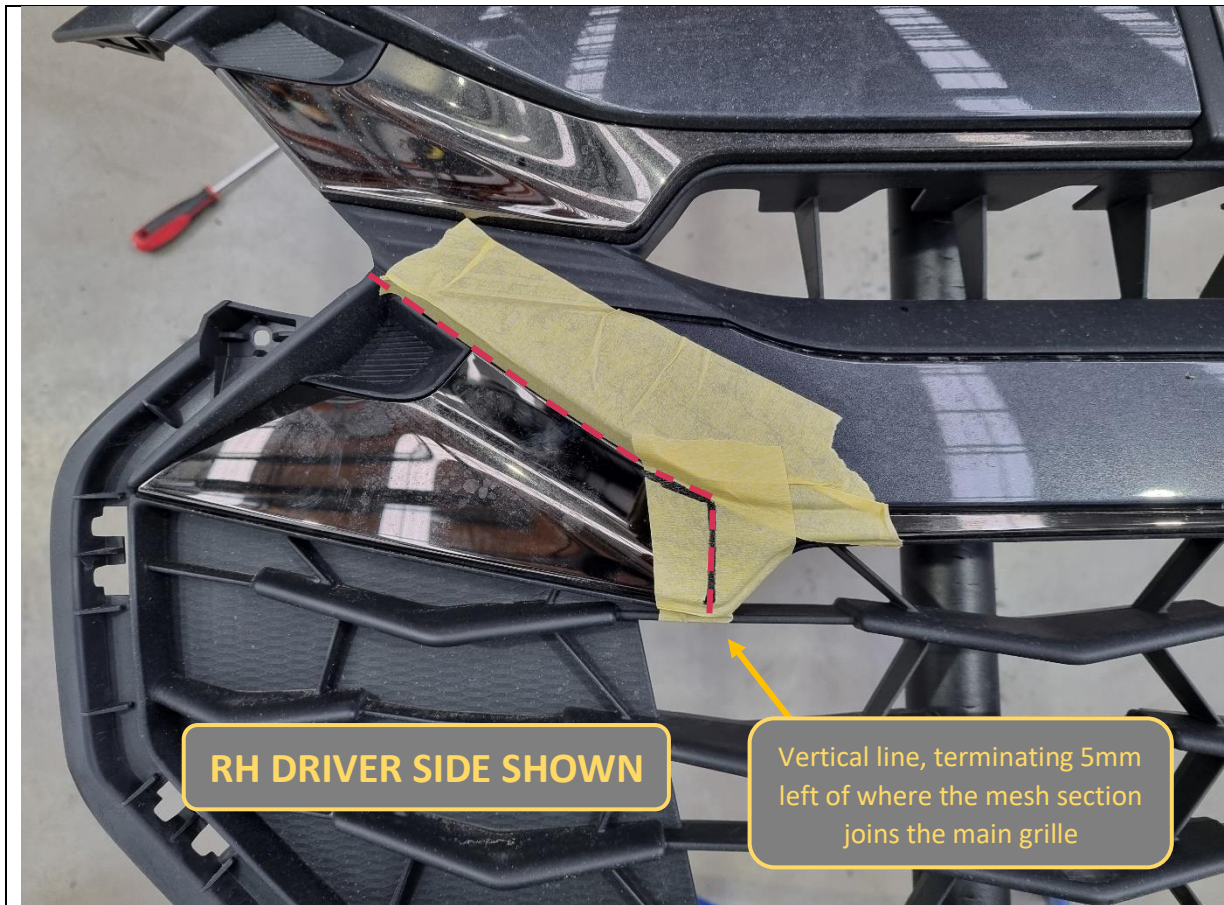

<p>35. Apply masking tape onto the outside of the grille as shown.</p> <p>36. Use a marker pen and mark a cut line as shown.</p> <p>37. Repeat for the other side.</p>	<p>TOOLS REQUIRED</p> <p>Marker pen Masking tape</p>
	<p>FASTENERS</p>

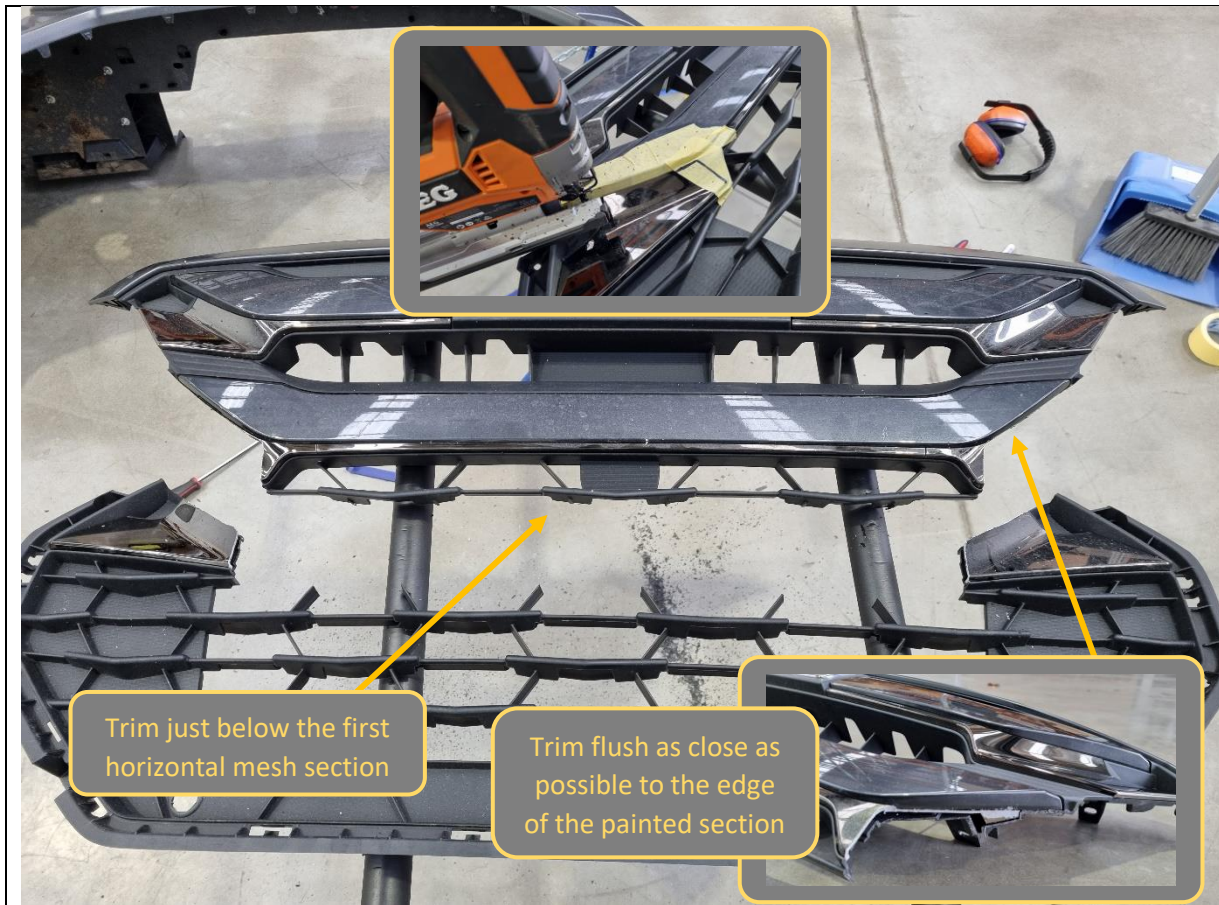

- 38. Trim the grille along the marked cut line.
- 39. Trim as close as possible to the edge of the painted section to get a flush cut face.
- 40. Trim horizontally along the grille, just below the first horizontal mesh section.
- 41. Discard the lower section of the grille.

TOOLS REQUIRED

Jigsaw
or
Air hacksaw

FASTENERS

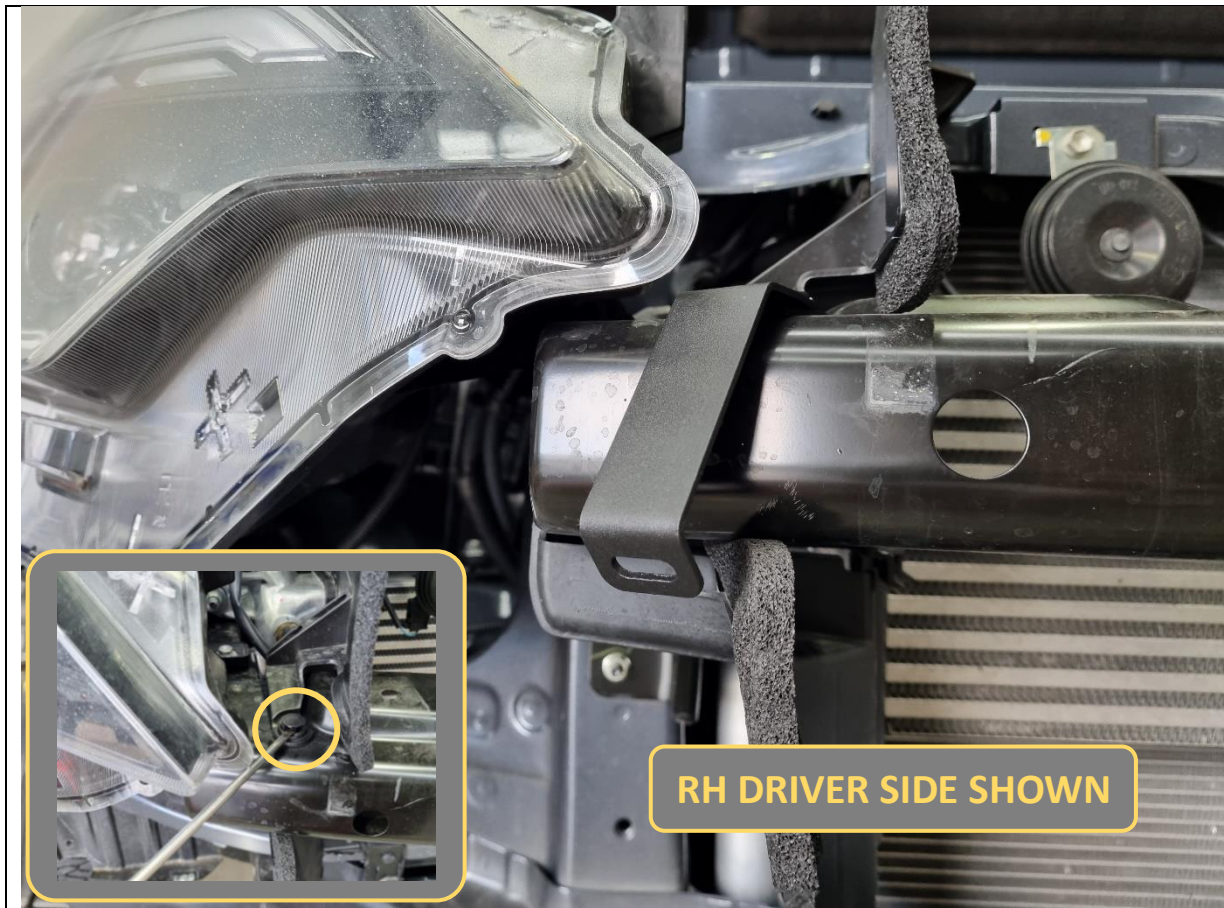

- 42. Remove the 1x plastic push clip holding the upper air guide.
- 43. Fit the B-1296 grille infill brace over the air guide and re-secure using the same plastic push clip.
- 44. Orient the brace in the position as shown above, then repeat for other side.

TOOLS REQUIRED

Flat blade screwdriver
or
Trim tool

FASTENERS



45. Re-fit the grille, radiator grille cover and factory air intake scoop to the vehicle. Secure using original plastic push clips.

TOOLS REQUIRED

FASTENERS

13x plastic push clips



- 46. Clean the highlighted headlight surfaces with isopropyl alcohol and a rag.
- 47. Also clean the top flange surfaces of the supplied plastic grille infills, as indicated by the arrows in the above inset image.

TOOLS REQUIRED

Isopropyl alcohol
Workshop rag

FASTENERS

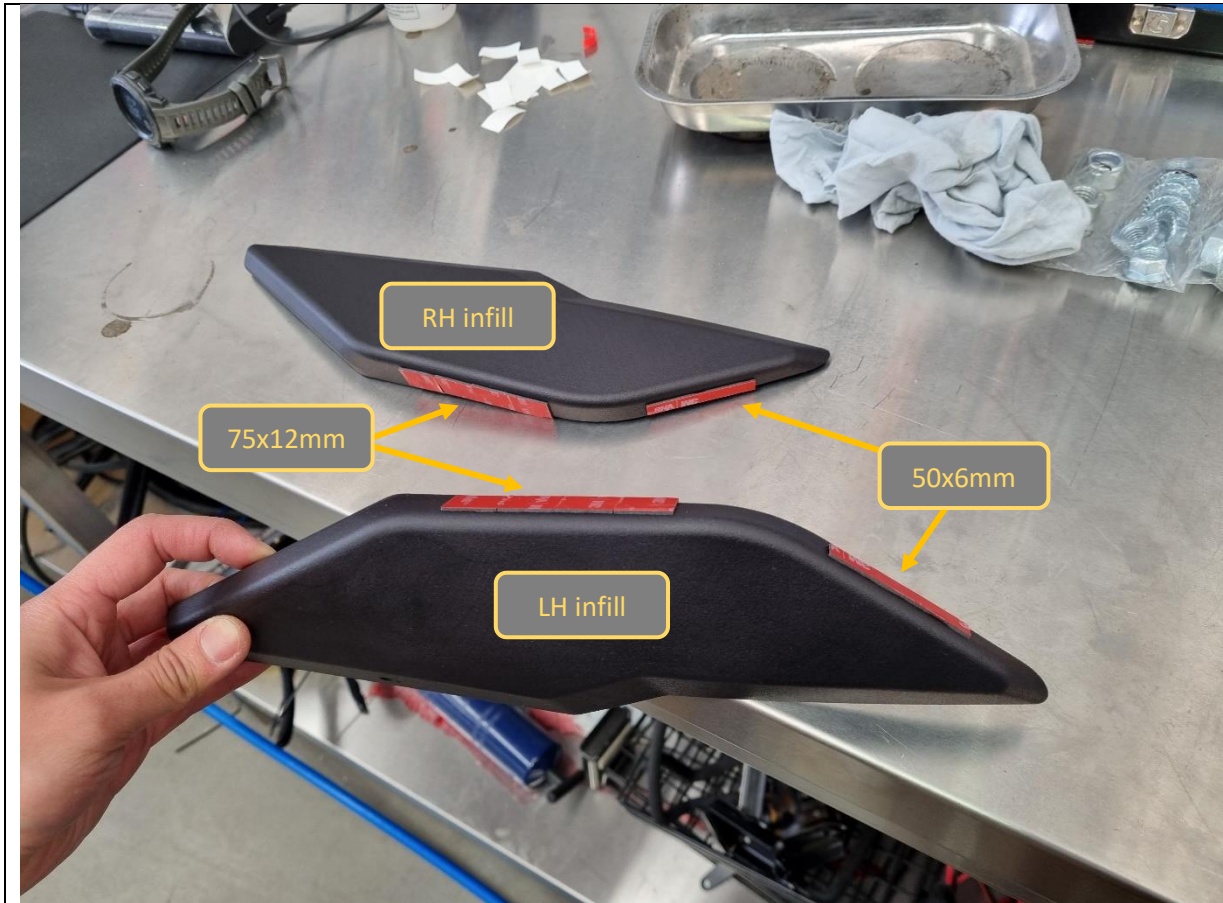

48. Apply supplied 3M VHB tape strips to the 2x grille infills as shown.

TOOLS REQUIRED

FASTENERS

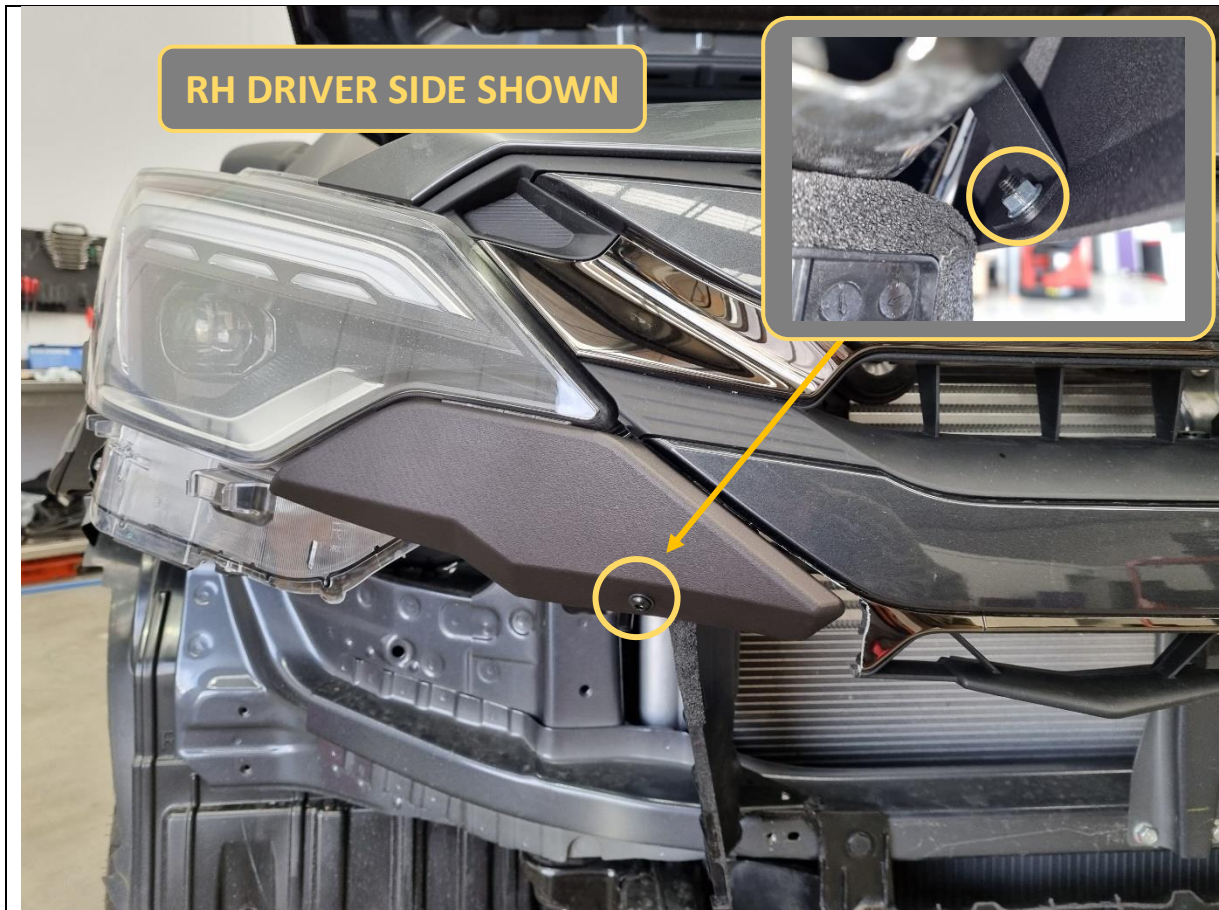

49. Peel off the red backing film for the tape strips, then adhere the grille infill to the bottom inside corner of the headlight.
50. Hold the infill in place and press firmly up against the headlight for at least 20 seconds for the tape to properly adhere.
51. Secure the bottom of the infill to the B-1296 infill brace using 1x M6x16 black button head bolt, black washer and flange nut.
52. Repeat for other side.

TOOLS REQUIRED

4mm hex/Allen key

FASTENERS

2x M6x16 black button head bolt
2x M6 black flat washer
2x M6 flange nut

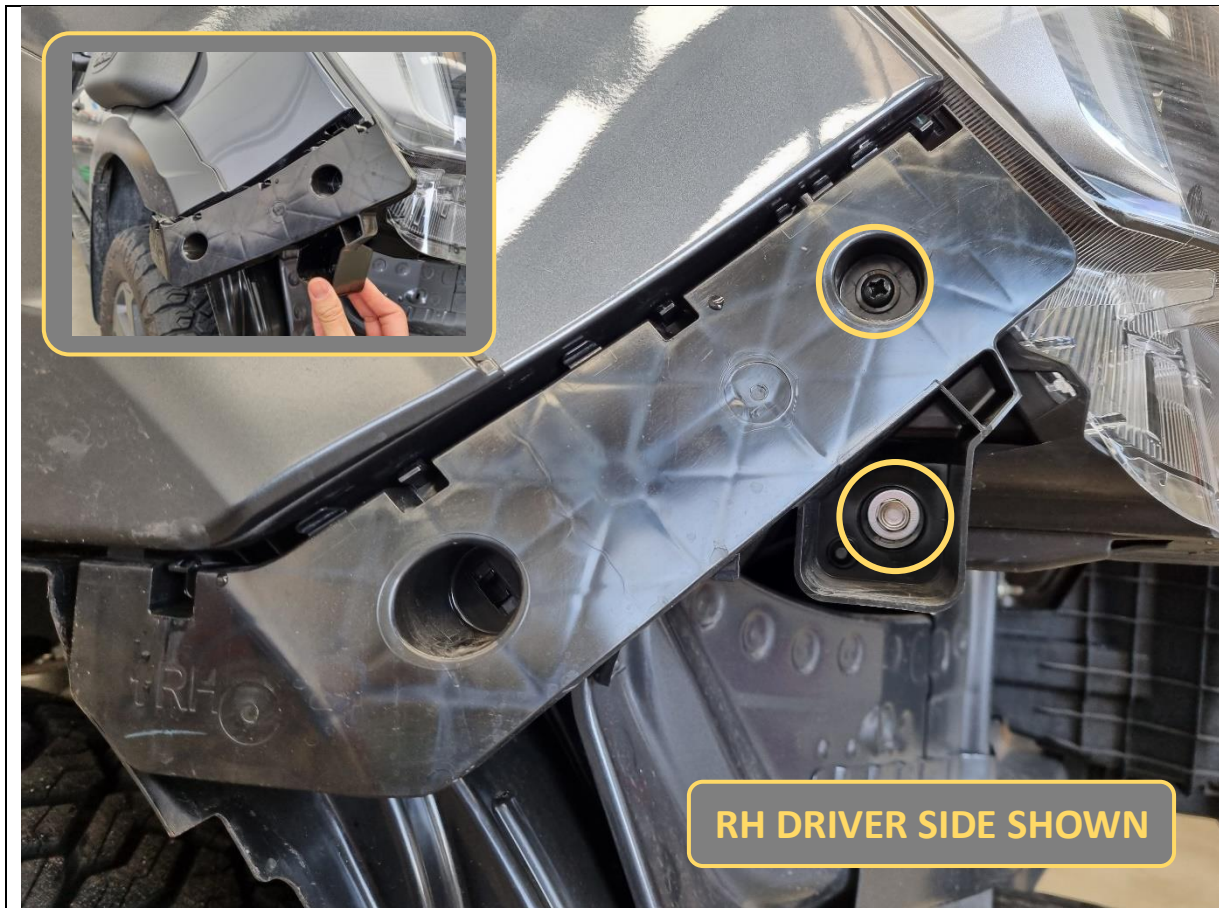

- 53. Remove the 1x 10mm hex bolt and 1x Phillips head screw securing the outer plastic bumper clip. Retain the hex bolt.
- 54. Remove the outer plastic bumper clip. A firm tug will be required to release the clips. Discard afterwards.
- 55. Do this for both sides.

TOOLS REQUIRED

Phillips head screwdriver
10mm socket

FASTENERS

2x Phillips head screw (discard)
2x factory 10mm hex bolt (retain)



- 56. Clean the corner of the quarter panel with isopropyl alcohol and a rag, as indicated by the arrow.
- 57. Also clean the top flange surfaces of the supplied headlight corner infills, as indicated by the arrows in the above inset image.

TOOLS REQUIRED

Isopropyl alcohol
Workshop rag

FASTENERS



<p>58. Apply 1x 30x6mm VHB tape strip to each headlight corner infill, as shown.</p> <p>59. Peel off the red backing film for the tape strip, then adhere the headlight corner infill to the quarter panel.</p> <p>Note the top bolt hole of the infill is fitted <u>behind</u> the quarter panel sheet metal, and the lower bolt hole on the outside of the headlight.</p>	<p>TOOLS REQUIRED</p> <p>4mm hex/Allen key 10mm socket/spanner</p>
<p>60. Hold the infill in place and press firmly up against the quarter panel for at least 20 seconds for the tape to properly adhere.</p> <p>61. Secure the top of the headlight corner infill with 1x M6x16 button head bolt, black flat washer and flange nut. Secure the bottom by re-using the factory 10mm hex bolt into the headlight.</p> <p>62. Repeat for other side.</p>	<p>FASTENERS</p> <p>2x M6x16 black button head bolt 2x M6 black flat washer 2x M6 flange nut</p> <p>2x factory 10mm hex bolts</p>

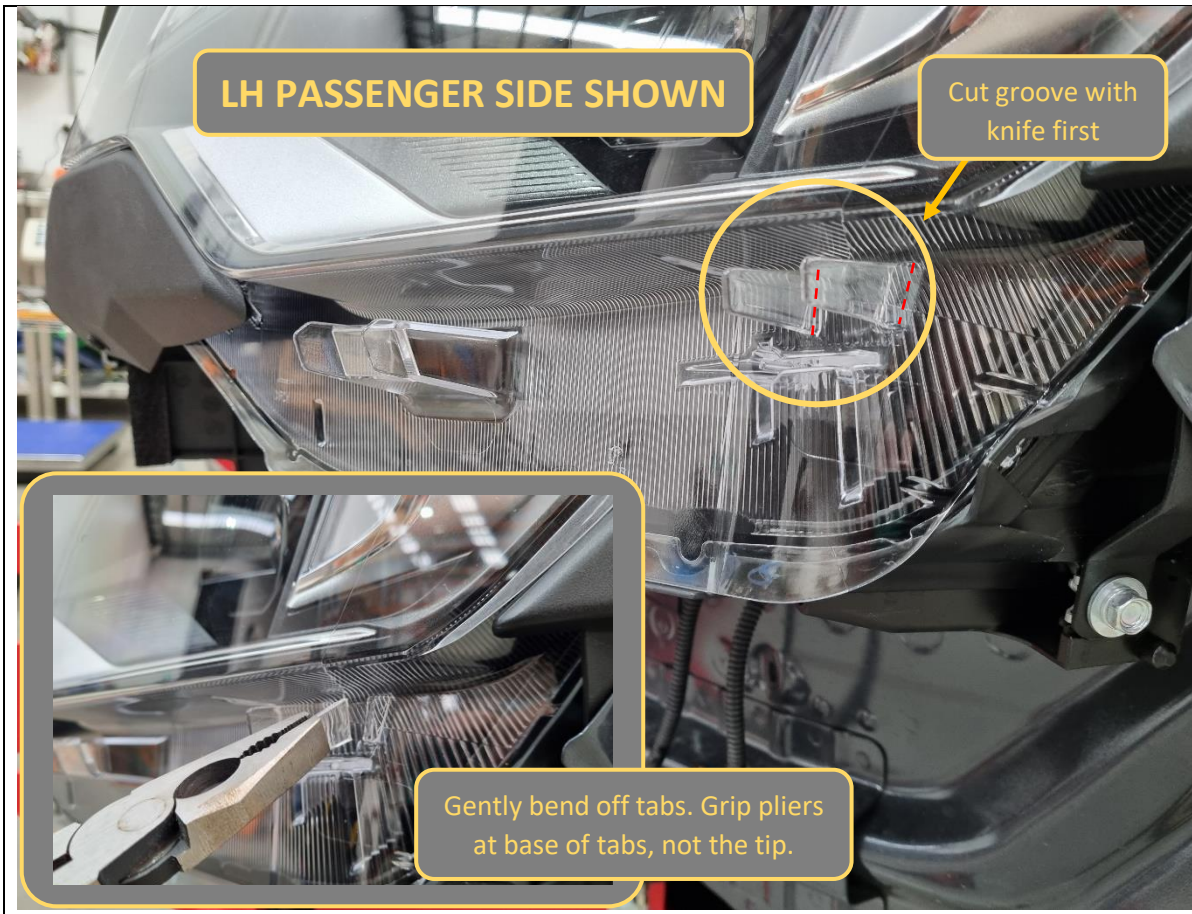

<p>63. Use a utility knife and cut a groove along the base of the outermost plastic tabs under each headlight. (See dashed lines in circled area above)</p> <p>64. Use a pair of pliers to gently snap/bend off the 2x outermost plastic tabs under each headlight. <u>Do not use excessive force.</u></p>	<p>TOOLS REQUIRED</p> <p>Utility knife Pliers</p>
	<p>FASTENERS</p>

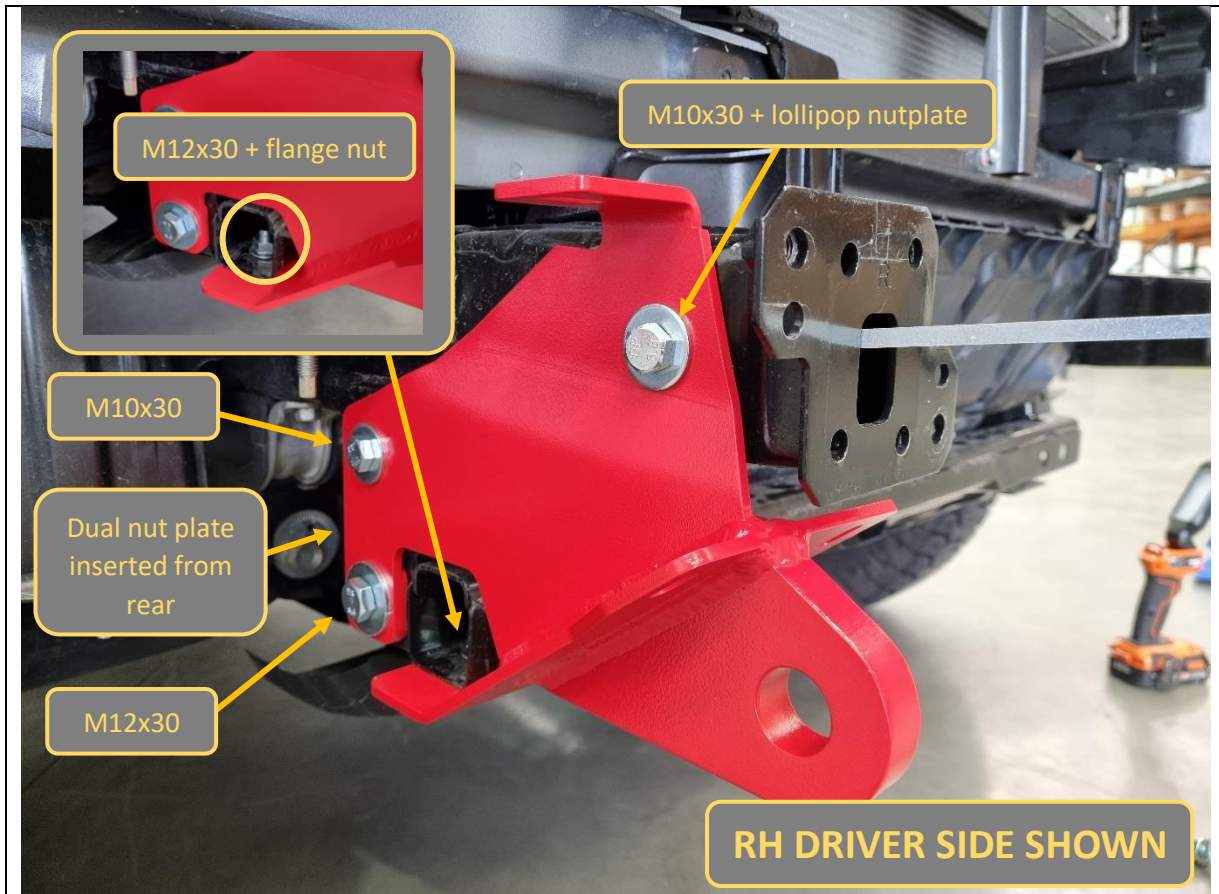

<p>65. Fit the tow point to the outside of the chassis rail.</p>	<p>TOOLS REQUIRED</p>
<p>66. Loosely secure the bottom of the tow point to the horizontal chassis cross member with 1x M12x30 hex bolt, heavy-duty washer and flange nut.</p> <p>67. Insert 1x M10 lollipop nutplate through the front opening of the chassis rail, then loosely secure to the tow point with 1x M10x30 hex bolt and heavy-duty washer.</p> <p>68. Insert the dual nutplate through the back of the chassis drop member and loosely secure to the tow point with 1x M12x30 hex bolt, 1x M10x30 hex bolt and heavy-duty washers.</p> <p>69. Repeat for other tow point.</p>	<p>FASTENERS</p> <p>4x M10x30 hex bolt 4x M10 heavy-duty washer 4x M12x30 hex bolt 4x M12 heavy-duty washer 2x M12 flange nut 2x M10 lollipop nutplate 2x dual nutplate</p>

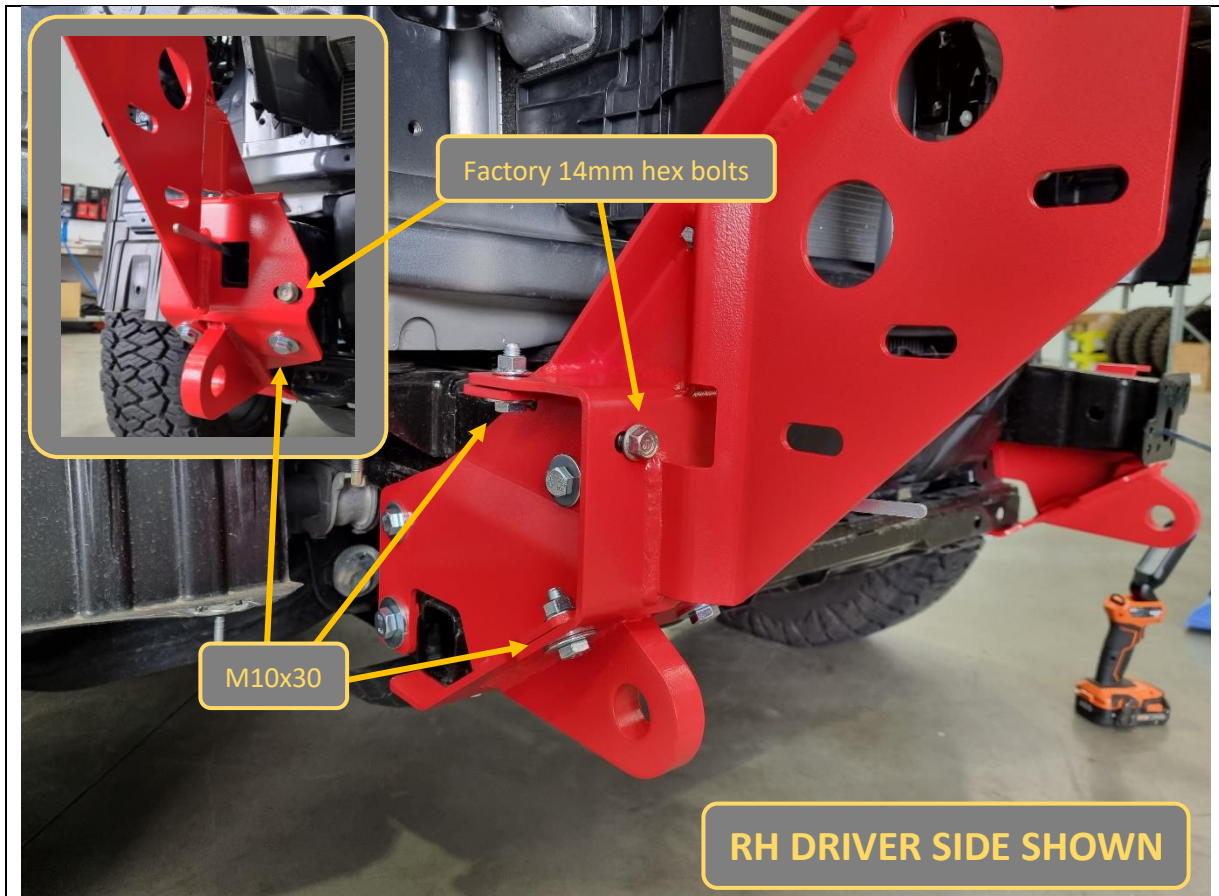

- 70. Fit the impact assembly to the chassis and loosely secure using 2x factory 14mm hex bolts retained from the crash beam.
- 71. Secure the impact assembly to the tow point using 3x M10x30 hex bolts, heavy-duty washers and flange nuts as shown.
- 72. Repeat for both sides of vehicle. Leave all bolts in the tow points and impact assemblies finger tight at this stage.

TOOLS REQUIRED

FASTENERS

- 4x factory 14mm hex bolt
- 6x M10x30 hex bolt
- 6x M10 heavy-duty washer
- 6x M10 flange nut

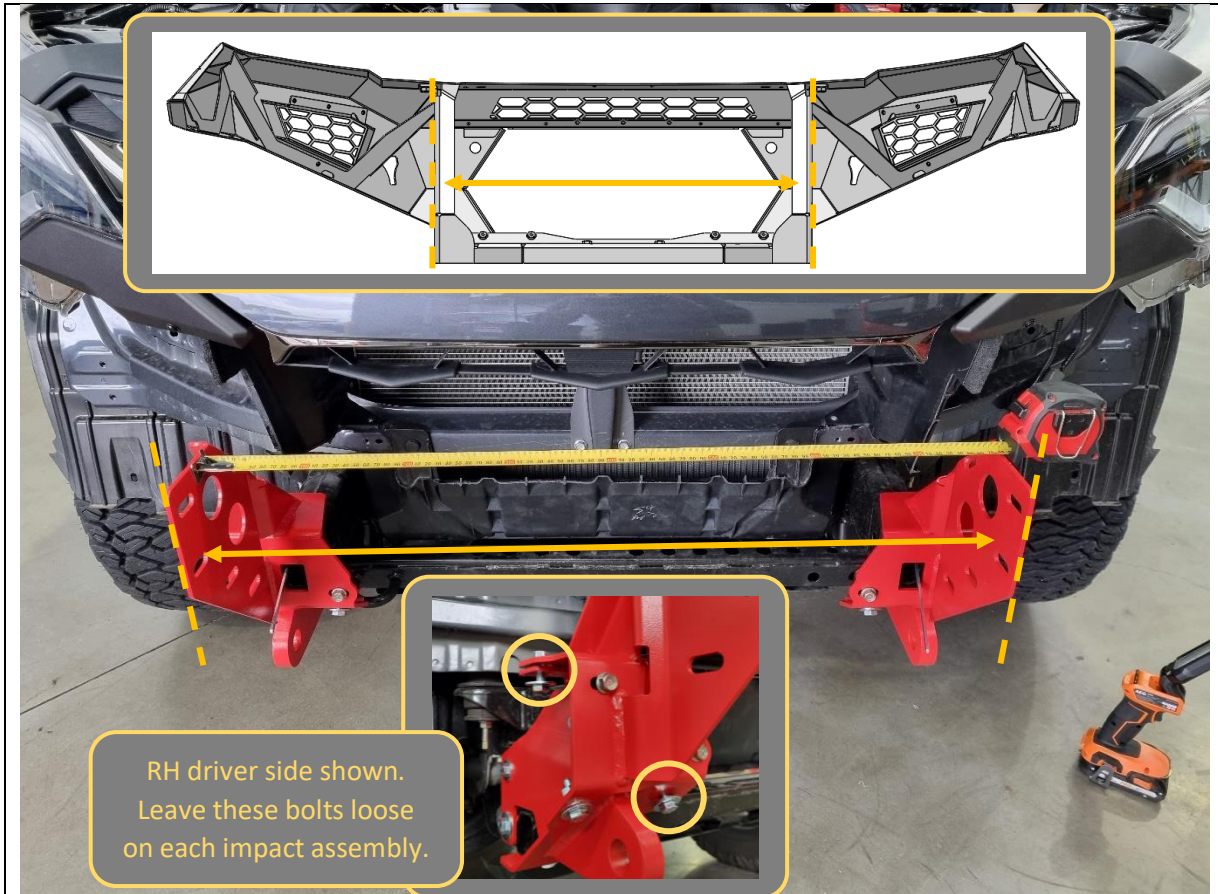

73. Measure the distance between the outside faces of uprights on bar using tape measure. Write distance below for reference if required.

Bar Upright Width = _____ mm

74. Adjust mounts by sliding left/right on the slots, such that distance between inner faces of mounts are 2-5mm more than bar. Ensure the mount faces are vertically upright and symmetric left/right on the chassis.

75. Tighten all bolts securing impact assemblies and tow points, except those highlighted (used later for attaching bash plates and side underpanels).

76. Re-check the distance and re-adjust as required.

TOOLS REQUIRED

Tape measure

14mm socket/spanner
16mm socket/spanner
19mm socket/spanner

FASTENERS

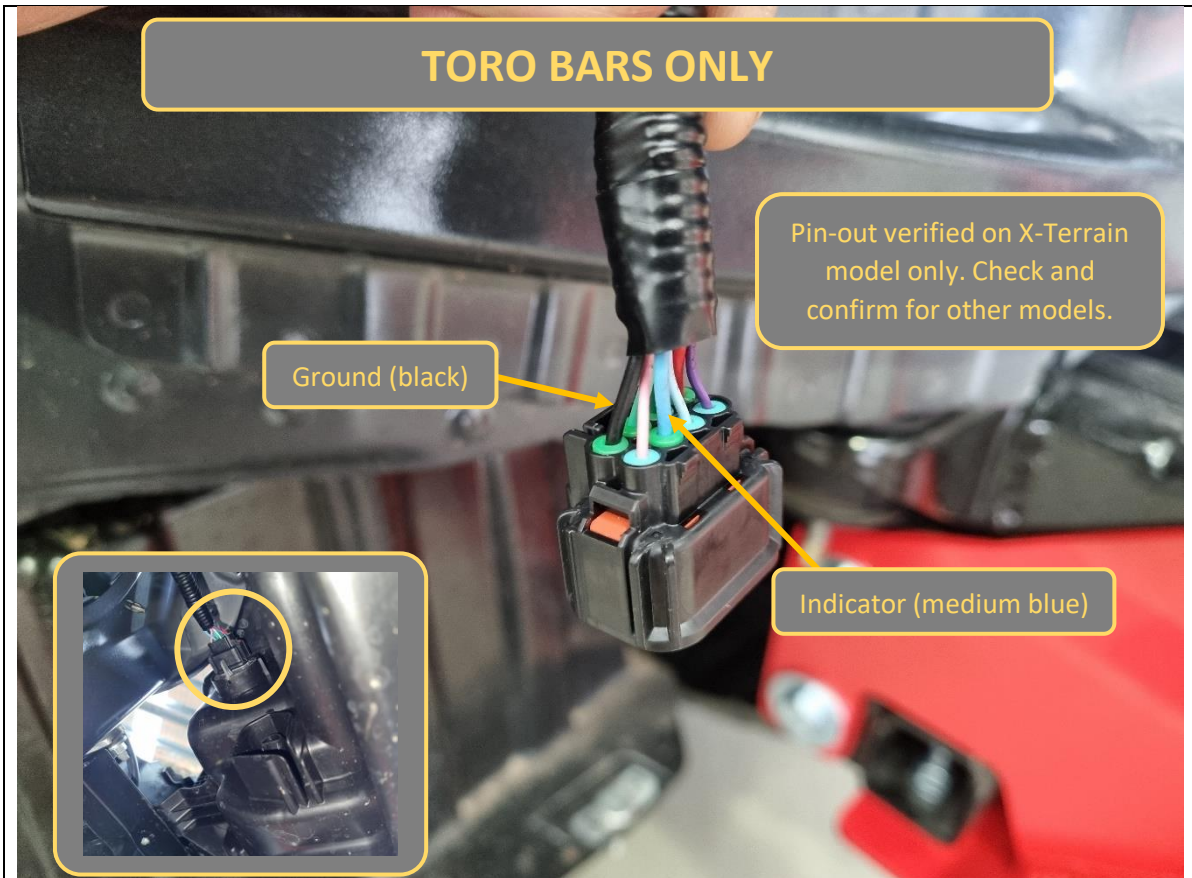

<p>77. Toro only. Locate the plug on the back of each headlight and disconnect.</p> <p>78. Toro only. Probe with a test light to confirm indicator signal and ground. On X-Terrain models, the wiring pinout is as follows:</p> <p>Medium blue = Indicator signal Black = Ground</p> <p>79. Toro only. Splice and solder automotive electrical wires into the harness for indicator signal and ground. Use heat shrink or electrical tape to insulate solder connections. Do this for both LH and RH indicators, then re-connect headlights.</p>	<p>TOOLS REQUIRED</p> <p>Cutting pliers Wire strippers Soldering iron Solder Automotive electrical wire Heat shrink Heat gun Electrical tape</p>
	<p>FASTENERS</p>



<p>80. Toro only. Fit indicator units to the indicator mounting bracket, using fasteners supplied with the indicator.</p>	<p>TOOLS REQUIRED</p> <p>Refer to instructions supplied with indicators</p>
	<p>FASTENERS</p> <p>Supplied with indicators</p>



<p>81. Toro only. Fit the indicator and bracket to the inside of the bullbar wing.</p> <p>82. Toro only. Secure with 3x M6x16 button head bolts, black washers and flange nuts.</p> <p>83. Toro only. Repeat for other side.</p>	<p>TOOLS REQUIRED</p> <p>4mm hex/Allen key</p>
	<p>FASTENERS</p> <p>6x M6x16 black button head bolt 6xx M6 black flat washer 6x M6 flange nut</p>

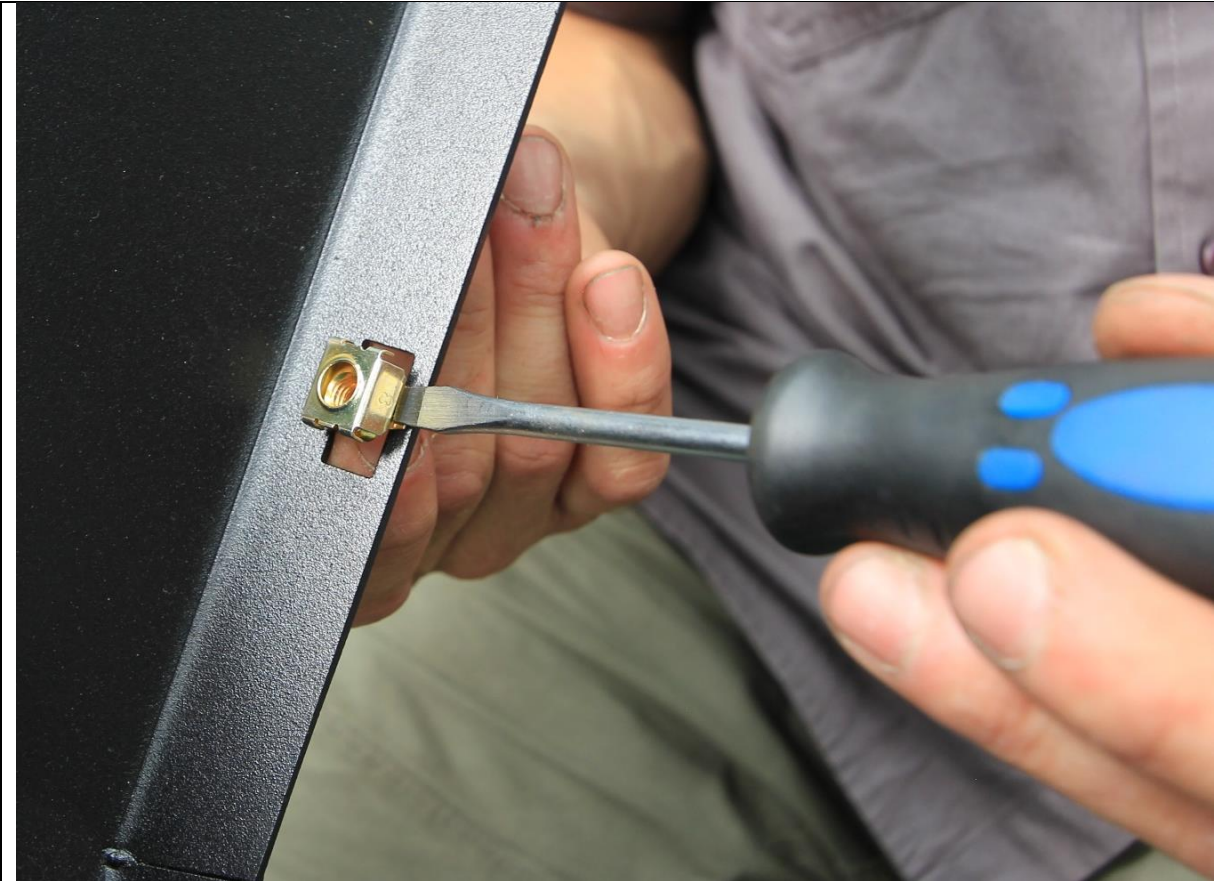

84. Fit 10x M6 cage nuts into the rectangular slots in bottom of wing (5x per side)

Use a small flat blade screwdriver to push the edge of the cage to engage with the slot to aid fitting.

TOOLS REQUIRED

Flat blade screwdriver

FASTENERS

10x M6 cage nuts



<p>85. If fitting an integrated light bar, do so now.</p> <p>This bar is designed to fit the Offroad Animal 22-inch light bar. If fitting this light bar, assemble the light bar with legs facing outwards, and line it up with the slots in the centre gusset. Secure with M6 fasteners supplied with the light.</p> <p>This bar can accommodate most other “20-22inch” size single row light bars. Stedi ST3K light bars require legs facing outwards.</p>	<p>TOOLS REQUIRED</p> <p>Supplied with accessories</p>
<p>86. If fitting driving lights, stealth hoop, round hoop or rally hoop to this bar, this is also the most convenient time to do so. It is still possible later but is more difficult.</p>	<p>FASTENERS</p> <p>Supplied with accessories</p>



87. Route the bumper wiring harness through the inside of the bullbar.

Use the provided cutouts to route parking sensors to the round holes in the bullbar.

If required, temporarily disconnect fog lights/parking sensors to route through.

Ensure harness is orientated correctly, with plugs connecting to the vehicle on the LH side.

TOOLS REQUIRED

FASTENERS

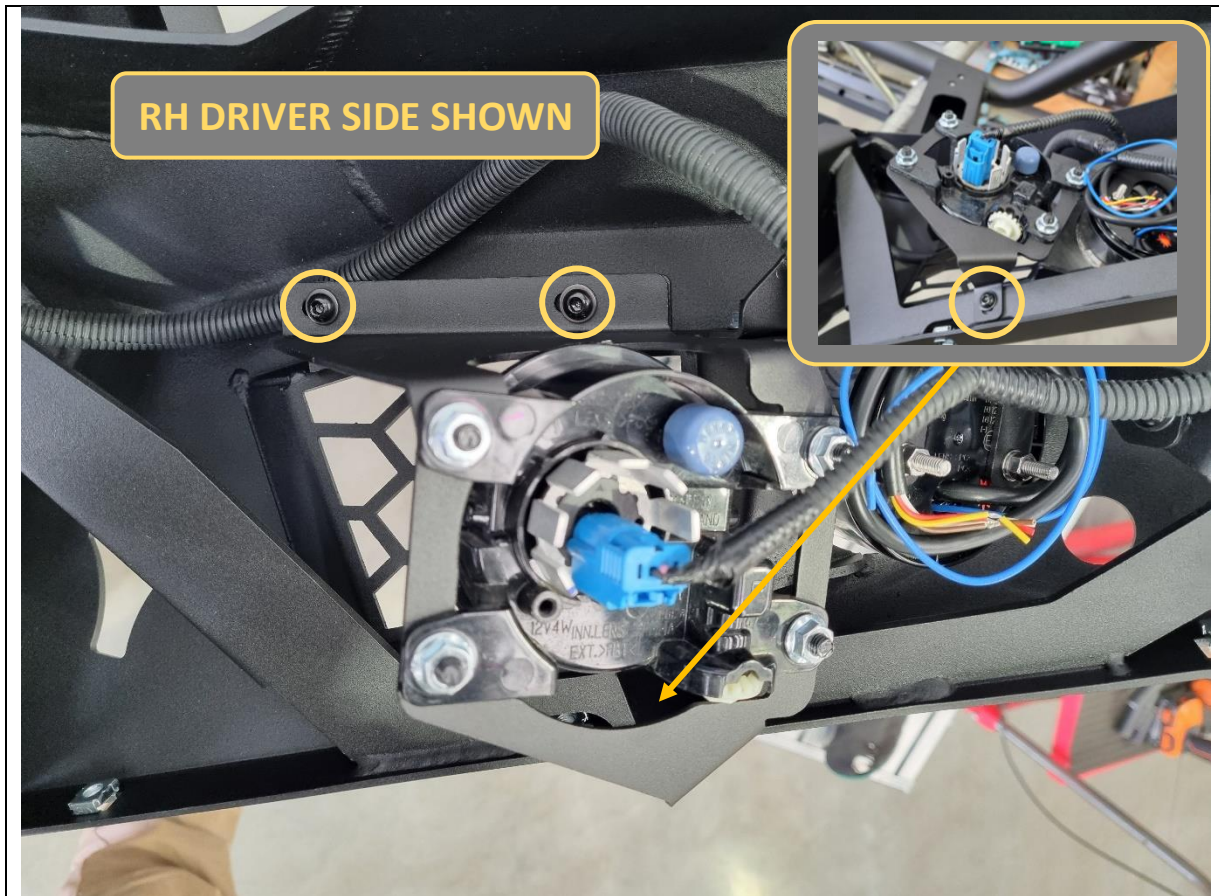

- 88. If equipped, fit the fog lights to the supplied mounting bracket and secure with 4x M6x16 black button head bolts, black washers and flange nuts.
- 89. Then fit the fog light and mounting bracket to the inside of the bullbar wing, and secure with 3x M6x16 black button head bolts and black washers.
- 90. Repeat for other side.

TOOLS REQUIRED

4mm hex/Allen key

FASTENERS

14x M6x16 black button head bolt
14x M6 black flat washer
8x M6 flange nut



<p>91. Fit the pan brace to the back of the top centre section of the bullbar.</p> <p>92. Secure the bottom of the pan brace to the back of the bar with 3x M6x16 black button head bolts and black washers.</p> <p>93. Secure the top of the pan brace to the top face of the bar with 2x M6x16 black button head bolts, black washers and flange nuts.</p>	<p>TOOLS REQUIRED</p> <p>4mm hex/Allen key</p>
	<p>FASTENERS</p> <p>5x M6x16 black button head bolt 5x M6 black flat washer 2x M6 flange nut</p>

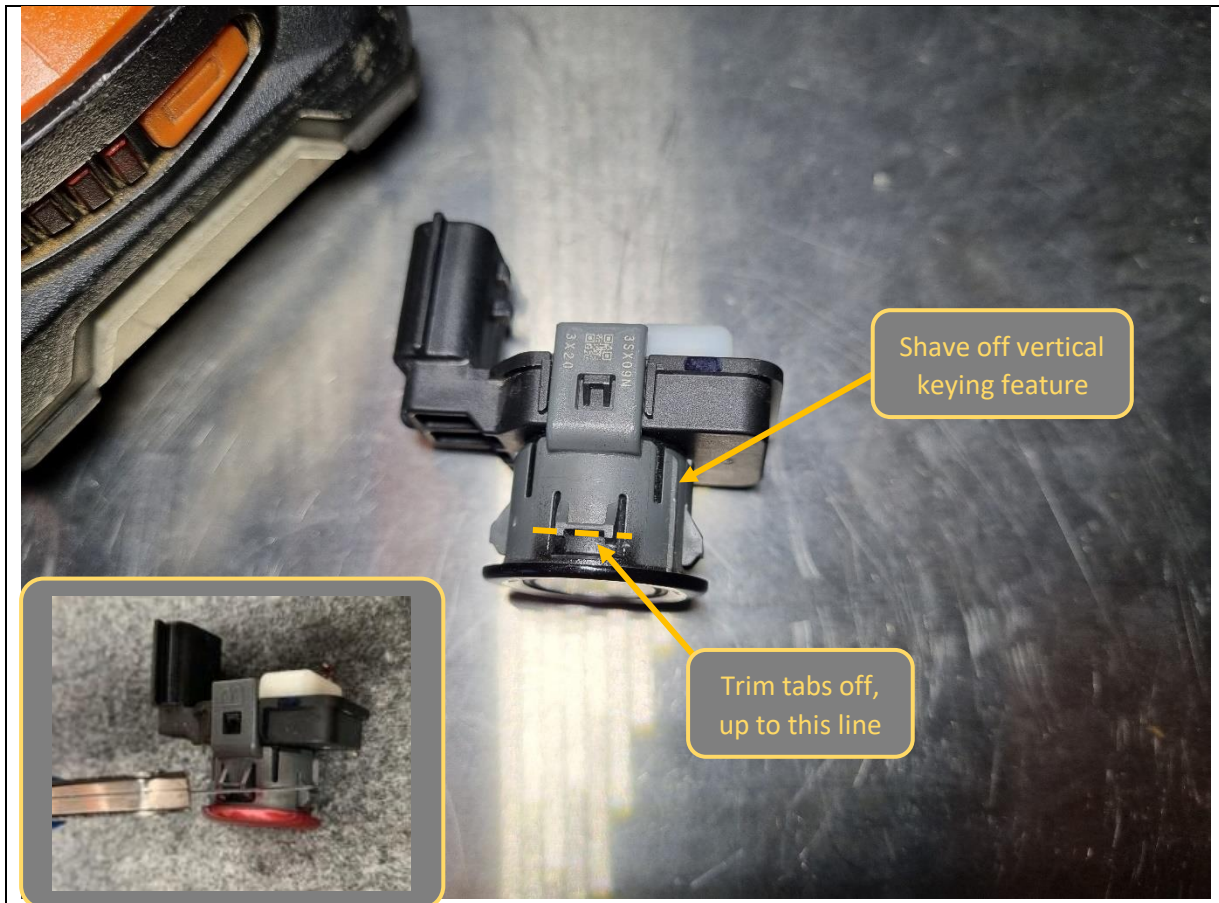

- 94. If equipped, the plastic parking sensor holders need to be modified to be able to clip them into the bullbar.
- 95. Disconnect the parking sensor with holder attached from the loom. Take care not to mix the location of each sensor on the harness.
- 96. Using a utility knife, trim 2mm off the front of the push in tabs (up to the join in the middle as shown).
- 97. Do for all 4 tabs around each sensor holder.
- 98. Also shave off the vertical keying feature on each sensor holder so that it is flush with the main cylindrical barrel of the sensor holder.
- 99. Re-fit parking sensors back to the harness in the bar in their correct positions.

TOOLS REQUIRED

Utility knife

FASTENERS



<p>100. If parking sensors are not equipped, insert the supplied plastic round blanking plugs into all 4x parking sensor holes in the bullbar (see inset photo).</p> <p>101. Otherwise, temporarily separate the sensor holder from each parking sensor, then clip into the 4x round holes in the bullbar, ensuring the orientation matches the original bumper.</p>	<p>TOOLS REQUIRED</p>
<p>102. Fit the parking sensors back into each sensor holder, with the plugs facing the correct direction.</p> <p>103. If the sensor holder is loose and is rotating in the bar, apply a small blob of adhesive (eg. Sikaflex silicone adhesive) to fix its position.</p>	<p>FASTENERS</p>



<p>104. Toro only. If required, fit the supplied antenna mounting brackets to the back of the bar, and secure with 2x M8x25 black button head bolts and black washers, each.</p>	<p>TOOLS REQUIRED</p> <p>5mm hex/Allen key</p>
<p>105. Toro only. Else fit the 2x M8x25 black button head bolts and black washers to the back of each bullbar upright, to protect nut threads in bar for future use.</p>	<p>FASTENERS</p> <p>4x M8x25 black button head bolt 4x M8 black flat washer</p>



- 106. Fit the supplied lengths of side bulb pinch weld rubber to the outermost edge of the wing on each side of the bullbar.
- 107. Use a pair of side cutters to make a notch in the pinch weld, to go around the internal bracing in the bullbar (see inset photo).
- 108. Trim to length if required.

TOOLS REQUIRED

Side cutters

FASTENERS

2x side bulb pinch weld rubber



109. With assistance, either from another person or a lifting trolley, lift the bar onto the mounts on the vehicle.

110. Secure the bar to the mounts with 8x M12x30 bolts, heavy-duty washers and Nyloc + flange nuts. Leave finger tight at this stage. Note: Use a washer on both bolt and nut side for the Nyloc nut. 1x Nyloc required per side of the bar. 1x washer on the bolt side is all that is required with flange nuts.

111. Re-connect the 2x bumper harness connectors back to the vehicle.

112. Toro only. Connect the indicator repeater lamps to the vehicle headlight harness (solder/crimp together, ensure well insulated).

TOOLS REQUIRED

Lifting trolley

FASTENERS

8x M12x30 hex bolt
10x M12 heavy duty washer
2x M12 Nyloc nut
6x M12 flange nut

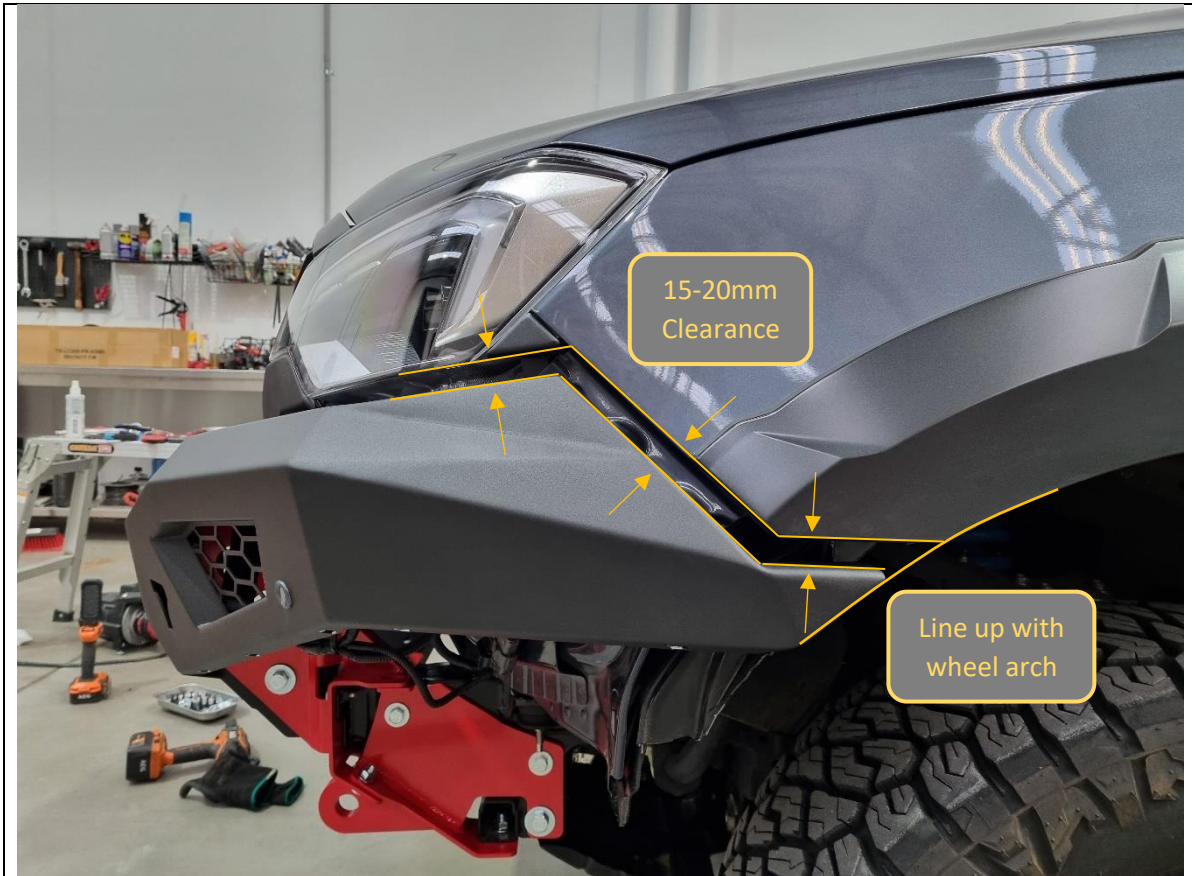

113. With assistance, from another person, align the bar with the edges of the vehicle. Adjust such that the clearances are neat, and the bar is symmetric left/right on the vehicle.

Acceptable range of clearances are outlined below. **Ensure clearances are maintained all the way through below the headlight.**

Front view: the bar should sit horizontally level with the body.

Side view: the bar should have 15-20mm vertical clearance to the quarter panel and headlight. The end of the bar wing should be in line with the wheel arch liner.

Top view: there should have 10-15mm clearance between the bar and grille.

114. Once happy with alignment, tighten all 8x M12 bolts.

TOOLS REQUIRED

Lifting Trolley

18/19mm socket/spanner

FASTENERS



<p>115. If fitting a winch, do so now.</p> <p>116. This bar is designed to fit most low mount winches, in foot down configuration. WARN ZEON 12 is the largest winch confirmed to fit.</p> <p>117. Ensure clutch handle will be accessible through opening in front mesh panel. Refer to winch instructions regarding changing clutch handle location.</p>	<p>TOOLS REQUIRED</p> <p>Refer to instructions supplied by winch</p>
	<p>FASTENERS</p> <p>Supplied with winch</p>

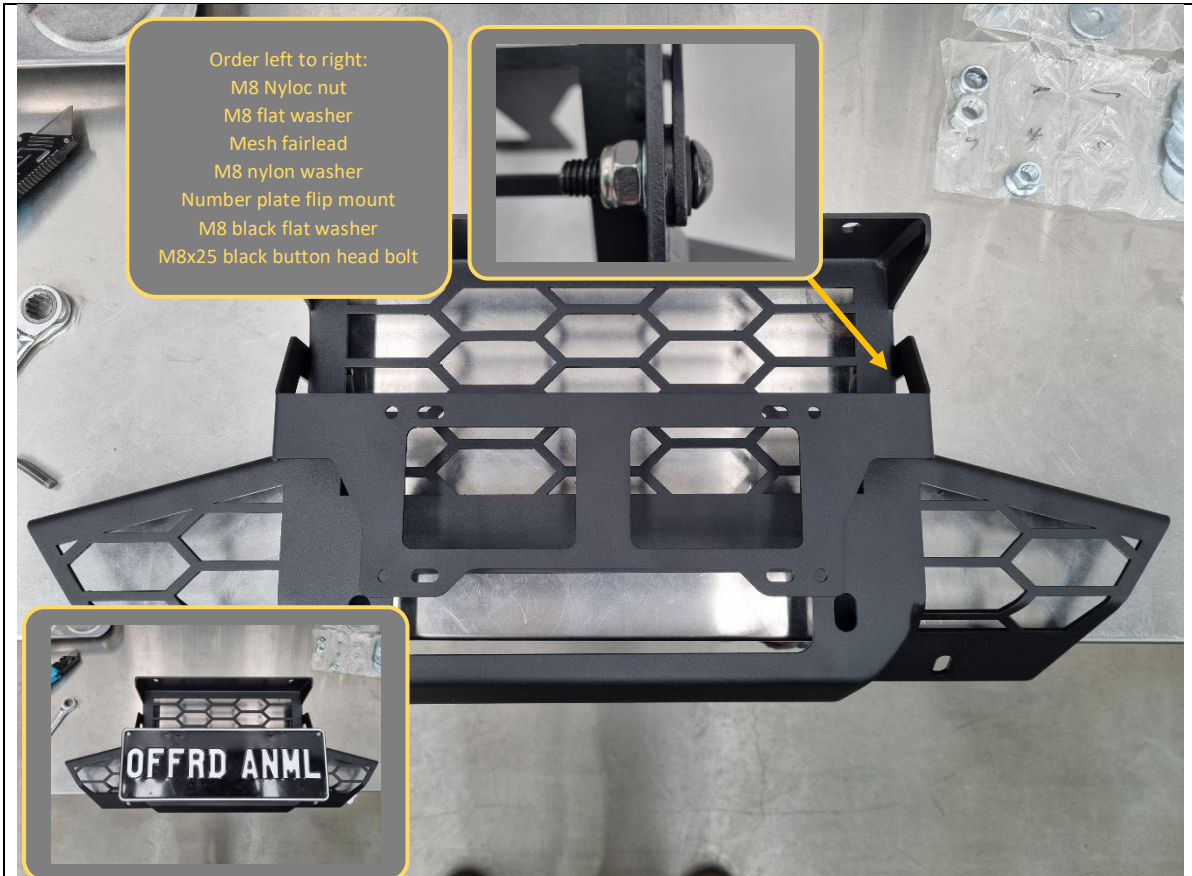

<p>118. Fit number plate flip mount to mesh panel as shown above. Tighten bolts so that flip mount and can be moved by hand with some friction resistance.</p> <p>119. Attach number plate to mount using 2x M6x16 black button head bolts, black washers and flange nuts.</p>	<p>TOOLS REQUIRED</p> <p>5mm hex/Allen key 13mm socket/spanner</p> <p>4mm hex/Allen key</p>
	<p>FASTENERS</p> <p>2x M8x25 black button head 2x M8 black flat washer 2x M8 nylon washer 2x M8 flat washer 2x M8 flange nut</p> <p>2x M6x16 black button head bolts 2x M6 black flat washer 2x M6 flange nut</p>



<p>120. If required, fit the winch fairlead to the mesh fairlead mount using M10 or 3/8" fasteners supplied with the winch. This bar is only compatible with hawse type fairleads.</p>	<p>TOOLS REQUIRED</p> <p>Refer to instructions supplied by winch</p>
	<p>FASTENERS</p> <p>Supplied with winch</p>



121. Fit the mesh fairlead mount to the centre of the bar, using 2x M8x16 black button head bolts + black washers (top), 2x M8x20 hex head bolts + heavy duty washers (bottom).
122. Tighten fasteners using 13mm socket/spanner and 5mm hex/Allen key.
123. Feed winch cable through the hawse fairlead if applicable.

TOOLS REQUIRED

13mm socket/spanner
5mm hex/Allen key

FASTENERS

2x M8x16 black button head
2x M8 black flat washer

2x M8x20 hex head
2x M8 heavy duty washer



124. Temporarily remove the 2x M10x30 hex bolts from the impact assemblies in preparation for fitting the bash plate. Set them aside.

125. Fit the centre bash plate and secure the top to the bullbar using 4x M8x25 black button head bolts and black washers.

TOOLS REQUIRED

5mm hex/Allen key

FASTENERS

4x M8x25 black button head bolt
4x M8 black flat washer



<p>126. Fit the supplementary lower bash plate and secure the rear through the factory underbody plate and into the chassis using the 2x factory 14mm hex bolts removed earlier.</p> <p>127. Secure the front of the supplementary bash plate to the centre bash plate/impact assemblies/tow points with 3x M10x30 hex bolts, heavy duty washers and flange nuts.</p>	<p>TOOLS REQUIRED</p> <p>14mm socket/spanner 16mm socket/spanner</p>
<p>Reach through the small access hole in the supplementary bash plate (see arrow) to reach middle flange nut.</p>	<p>FASTENERS</p> <p>2x factory 14mm hex bolt 3x M10x30 hex bolt 3x M10 heavy duty washer 3x M10 flange nut</p>

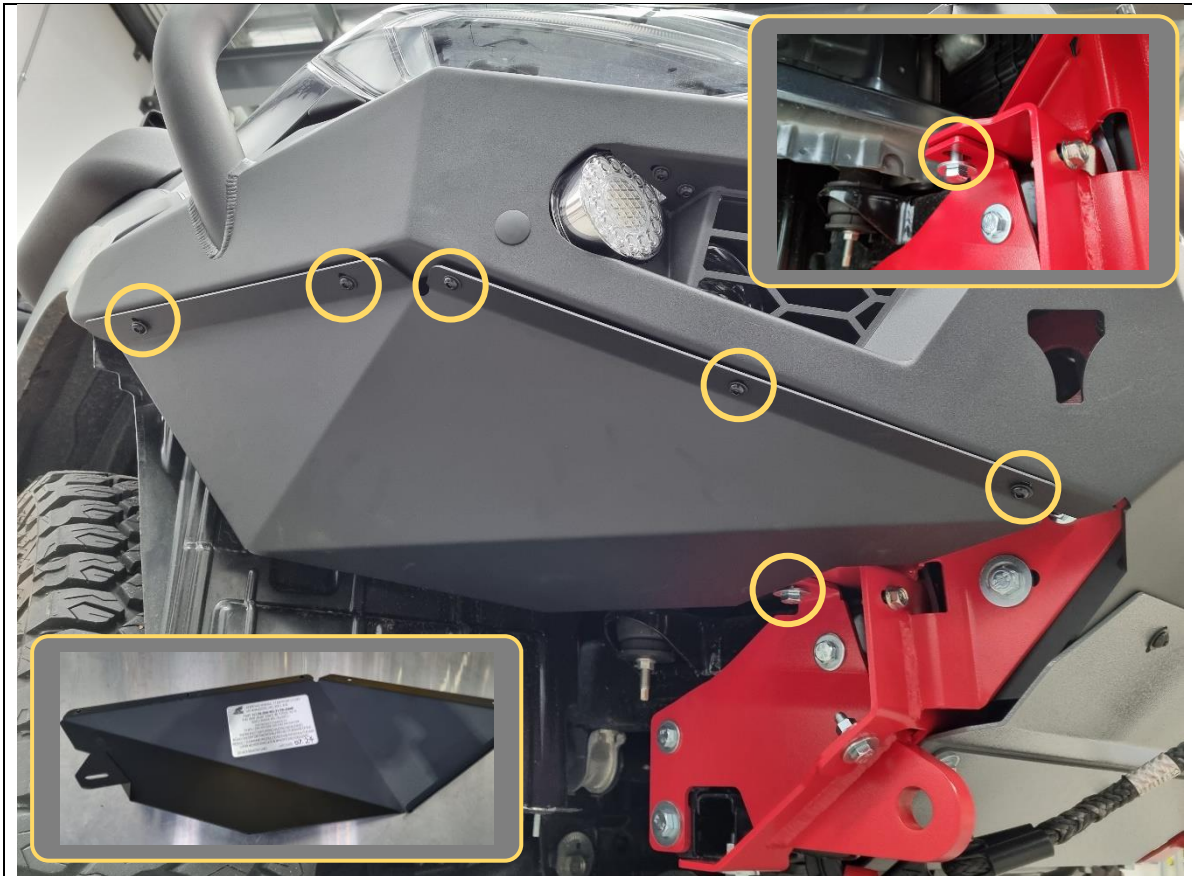

<p>128. Temporarily remove the 2x M10x30 hex bolts from the impact assemblies in preparation for fitting the bash plate. Set them aside.</p> <p>129. Affix the supplied ADR compliance plate on the inside of one of the side underpanels.</p>	<p>TOOLS REQUIRED</p>
<p>130. Fit the side underpanels by first sitting the bottom mount on top of the impact assembly, then loosely secure to the M6 cage nuts in the bullbar with 5x M6x16 black button head bolts and black washers, each.</p> <p>131. Loosely secure the bottom of side underpanels to the impact assemblies using the M10x30 hex bolts removed earlier.</p>	<p>FASTENERS</p> <p>10x M6x16 black button head bolt 10x M6 black flat washer 2x M10x30 hex bolt 2x M10 heavy duty washer 2x M10 flange nut</p>

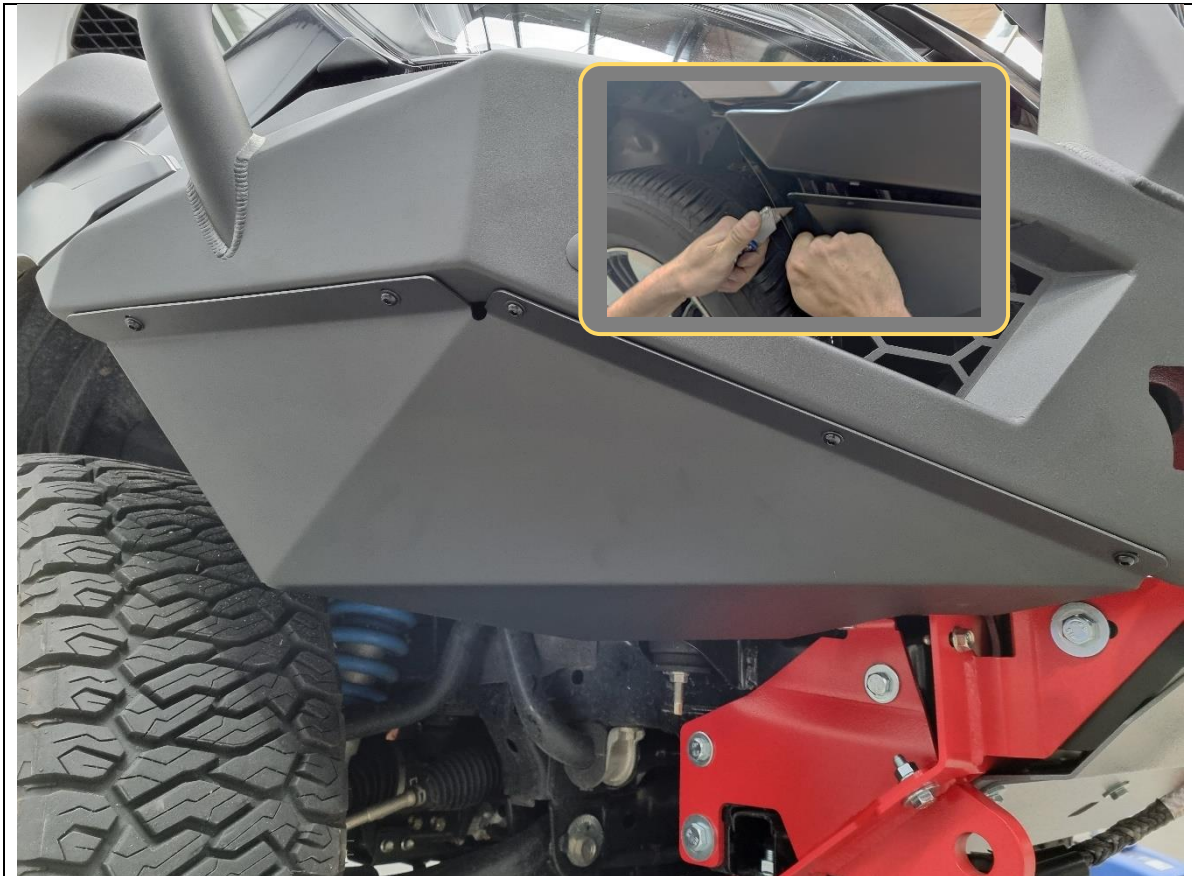

<p>132. Using a sharp utility knife, cut back the plastic inner wheel arch liner to match the profile of the side underpanel.</p> <p>133. Tuck the wheel arch liner behind the flange of the side underpanel.</p> <p>134. Tighten all side underpanel bolts and repeat for other side.</p>	<p>TOOLS REQUIRED</p> <p>Utility knife</p> <p>4mm hex/Allen key</p> <p>16mm socket</p>
	<p>FASTENERS</p>



<p>135. Review fitment and double check all bolts are tightened correctly.</p> <p>136. Check all wiring is connected, and that fog lights, indicators (Toro only) and parking sensors are all functional.</p>	<p>TOOLS REQUIRED</p>
	<p>FASTENERS</p>



Congratulations! You're done!
Head for the tracks in your newly protected D-MAX!