



Toyota Hilux N80 MY2015 on Predator & Toro Front Bar

IMPORTANT! – READ BEFORE INSTALLATION

- When installed in accordance with these instructions, the front protection bar does not affect the operation of the vehicles SRS airbags.
- This product must be installed exactly as per these instructions using only hardware supplied.
- Take a few moments to read instructions thoroughly before beginning work.
- In the event of damage to any bar component please contact OFFROAD ANIMAL to arrange repair/replacement of components.
- Do not use this product for any vehicle make or model other than that specified on these instructions.
- Do not remove labels from this product.
- This product and its fixings must not be modified in any way unless stated in these fitting instructions.
- The installation of this product is recommended for trained personnel.
- These instructions are correct at time of publication. OFFROAD ANIMAL cannot be held responsible for the impact of any changes subsequently made by the vehicle manufacturer. If you find something has changed please contact us to let us know!
- During installation it is the duty of the installer to check correct operation/clearances of all components.
- If Instructions are to be printed for reference in the workshop, it is recommended that they are printed in colour, for best legibility.

PARTS LISTING

IMPORTANT: Check all parts are present before beginning work! Contact OFFROAD ANIMAL if something is missing.

Main Parts – In the Box

Qty	Part Number	Description	Image
1	FB-THL-N80-15-PR-ASM1	Hilux N80 2015-2020 Predator Bar Weldment	
OR			
1	FB-THL-N80-21-PR-ASM1	Hilux N80 2021+ Predator Bar Weldment	
OR			
1	FB-THL-N80-15-PR-ASM1	Hilux N80 2015-2020 Toro Bar Weldment	
OR			
1	FB-THL-N80-21-PR-ASM1	Hilux N80 2021+ Predator Bar Weldment	

Common Fitting Kit Parts All Years

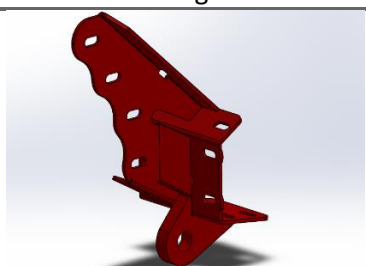
Qty	Part Number	Description	Image
1	FB-THL-N80-15-PR-ASM2L	Hilux Chassis Mount Assy	

1	FB-THL-N80-15-PR-ASM2R	Hilux Chassis Mount Assy	
1	B-0152L	Hilux Front Mount - Chassis Brace	
1	B-0152R	Hilux Front Mount - Chassis Brace	
1	M-0005	Hilux Mesh - Center Fairlead Support	
1	M-0006L	Hilux Mesh Infill LHS	
1	M-0006L	Hilux Mesh Infill RHS	
1	NPF-COM-SM-ASM0	Number plate flip asm Small	
1	U-0009	Hilux N80 Bash Plate	
1	U-0057L	Hilux Front Bar - Side Under panel	

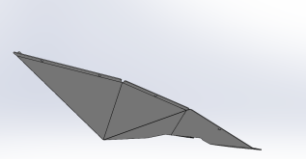
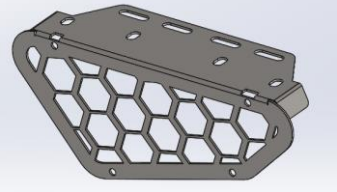
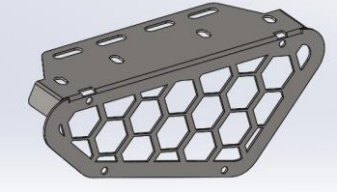
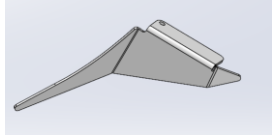
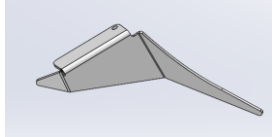
1	U-0057R	Hilux Front Bar - Side Under panel	
1	M-0002L	Light Cover Mesh	
1	M-0002R	Light Cover Mesh	
1	B-0886L	Hilux N80 Headlight Corner Infill	
1	B-0886R	Hilux N80 Headlight Corner Infill	
2	TK-FB-THL-N80-15	Tape Kit - Hilux N80, 3M 5952, 2x 25x8mm	No Image
1	TK-COM-PSEN-4	Tape Kit - 4 Sensor Universal	No Image

2015-2020 Specific Parts

Qty	Part Number	Description	Image
1	B-0185R	Toyota Style Fog Lamp Bracket RHS	
1	B-0185L	Toyota Style Fog Lamp Bracket LHS	
1	B-0195	Hilux Grille Support Bracket	

2021+ Specific Parts

Qty	Part Number	Description	Image
1	B-0514L	Hilux 21+ Style Fog Lamp Bracket LHS	
1	B-0514R	Hilux 21+ Style Fog Lamp Bracket RHS	
1	B-0515	Hilux 21+ Grille Support Bracket	
1	N-0009L	Hilux MY21 Plastic Bolt on Headlight Infill	
1	N-0009R	Hilux MY21 Plastic Bolt on Headlight Infill	
2	F-0032	N80 Hilux / N160 Fortuner Parking Sensor Holder	

Toro Additional Parts

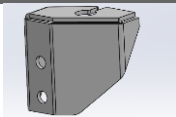
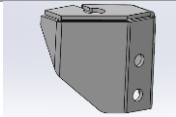
Qty	Part Number	Description	Image
1	B-0631L	Hilux Toro - Antenna mount	
1	B-0631R	Hilux Toro - Antenna mount	

2015-2020 Small Parts – Contained in Small Parts Kit Bag

Qty	Part Number	Description
19	M6 FLANGE NUT	Flange Nut, M6x1 G8.8 ZP
31	M6 FLAT WASHER BLACK ZINC	M6 Flat Washer, 12x6.1x1, ISO4042 ZnNi BLACK PASSIVATED FINISH
31	M6x16 BHCS BLACK ZINC	SCREW, BUTTON HEAD CAP, M6X16X1 GR12.9, ISO4042 ZnNi BLACK PASSIVATED FINISH
8	M12X40	Bolt Hex, M12X40X1.75, GR8.8 ZP
16	M12 FW LHD	M12 FW Large Heavy Duty
8	M12 Nyloc nut	M12 NYLOC NUT
10	M6CN3MM	CAGE NUT M6x2.6-3.5
8	M8X20	Bolt Hex, M8X20X1.25, GR8.8 ZP
8	M8 FLAT WASHER	M8 FW
14	M8 FLANGE NUT	Flange Nut, M8x1.25 G8.8 ZP
6	M8 X 20 BHCS BLACK ZINC	SCREW, BUTTON HEAD CAP, M8X20X1.25, ISO4042 ZnNi BLACK PASSIVATED FINISH
8	M8 FLAT WASHER- BLACK ZINC	M8 FLAT WASHER, 16.5x8.4x1.2, ISO4042 ZnNi BLACK PASSIVATED FINISH
2	M8 X 16 BHCS BZP	SCREW, BUTTON HEAD CAP, M8X16X1.25 GR12.9, ISO4042 ZnNi BLACK PASSIVATED FINISH
2	M10X30 BHCS	SCREW, BUTTON HEAD CAP, M10X30X1.5 GR12.9 ZP
12	M10 Flat Washer	M10 FW
12	M10 FLANGE NUT	Flange Nut, M10x1.5 G8.8 ZP
2	NP-THL-N80-15- PR	Nut Plate - Hilux Predator
6	M12 FLAT WASHER	M12 FW
4	M12X30	Bolt Hex, M12X30x1.75, GR8.8 ZP
10	M10 x 30	Bolt Hex, M10X30x[1.5], GR8.8 ZP
2	M12X30X1.25	Bolt Hex, M12X30x1.25, GR8.8 ZP

2021+ Small Parts – Contained in Small Parts Kit Bag

Qty	Part Number	Description
25	M6 FLANGE NUT	Flange Nut, M6x1 G8.8 ZP
37	M6 FLAT WASHER BLACK ZINC	M6 Flat Washer, 12x6.1x1, ISO4042 ZnNi BLACK PASSIVATED FINISH
37	M6x16 BHCS BLACK ZINC	SCREW, BUTTON HEAD CAP, M6X16X1 GR12.9, ISO4042 ZnNi BLACK PASSIVATED FINISH
8	M12X40	Bolt Hex, M12X40X1.75, GR8.8 ZP
16	M12 FW LHD	M12 FW Large Heavy Duty
8	M12 Nyloc nut	M12 NYLOC NUT
10	M6CN3MM	CAGE NUT M6x2.6-3.5
8	M8X20	Bolt Hex, M8X20X1.25, GR8.8 ZP
8	M8 FLAT WASHER	M8 FW
14	M8 FLANGE NUT	Flange Nut, M8x1.25 G8.8 ZP
6	M8 X 20 BHCS BLACK ZINC	SCREW, BUTTON HEAD CAP, M8X20X1.25, ISO4042 ZnNi BLACK PASSIVATED FINISH
8	M8 FLAT WASHER- BLACK ZINC	M8 FLAT WASHER, 16.5x8.4x1.2, ISO4042 ZnNi BLACK PASSIVATED FINISH
2	M8 X 16 BHCS BZP	SCREW, BUTTON HEAD CAP, M8X16X1.25 GR12.9, ISO4042 ZnNi BLACK PASSIVATED FINISH
2	M10X30 BHCS	SCREW, BUTTON HEAD CAP, M10X30X1.5 GR12.9 ZP
12	M10 Flat Washer	M10 FW
12	M10 FLANGE NUT	Flange Nut, M10x1.5 G8.8 ZP
2	NP-THL-N80-15- PR	Nut Plate - Hilux Predator
6	M12 FLAT WASHER	M12 FW
4	M12X30	Bolt Hex, M12X30x1.75, GR8.8 ZP
10	M10 x 30	Bolt Hex, M10X30x[1.5], GR8.8 ZP
2	M12X30X1.25	Bolt Hex, M12X30x1.25, GR8.8 ZP

TOOLS REQUIRED

The following tools will be required to install the product.

Hand Tools	Power Tools	Workshop Equipment
Metric Socket Set 8-19mm Socket Extension Bar Metric Spanner Set 10-19mm Hex (Allen) Key Set 4-8mm Trim Puller Tool Flat Blade Screwdriver set Phillips Head Screwdriver set Utility Knife	Electric/Air Impact Driver (Optional) Air Hacksaw or Angle grinder	Panel Stand or Soft Blanket Automotive Adhesive Sealant. Glue Removal Solvents

WORKSHOP SAFETY

It is the responsibility of the installer to always complete works in a safe manner. Make sure the following safety equipment is available and precautions are observed whilst fitting this product.

<p>Hearing Protection</p> 	<p>Always wear ear protection when using power tools.</p>
<p>Eye Protection</p> 	<p>Ensure eye protection is always worn when cutting or drilling.</p>
<p>Manual Handling</p> 	<p>Do not attempt to lift bar assemblies or rock sliders on your own.</p> <p>Always use two people to lift or use mechanical Lifting aid such as hydraulic lifting trolley.</p>
<p>Vehicle Support</p> 	<p>Always ensure vehicle is properly supported when working on it. Do not attempt to fit products whilst suspension work is being carried out. Do not work under a vehicle supported only by a jack.</p>

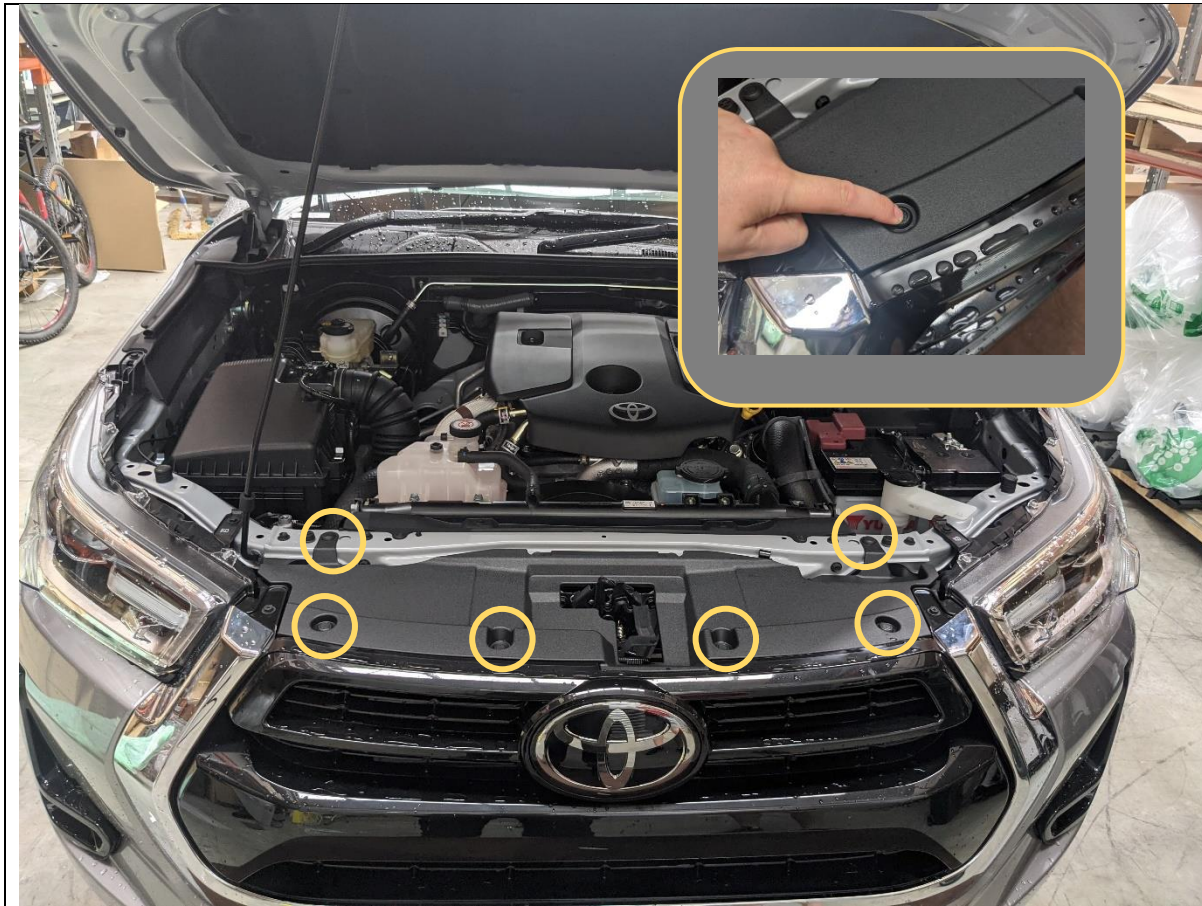

1. Note Most of these images show 2021-2023 model. 2015-2020 & 2024+ Models are similar. Where specific differences / extra steps exist they will be pointed out.
2. Remove the Radiator shroud by removing the 6x clips securing it to the grille and cross member.
3. Push down on the center of the clips to release then remove with trim tool.

TOOLS REQUIRED

Trim Tool

FASTENERS

Push Center Clips



4. Remove the 4x 10mm Head screws securing the top of the grille
5. Retain fasteners for re fitment.

TOOLS REQUIRED
10mm Socket / Spanner

FASTENERS
10mm Head Screws

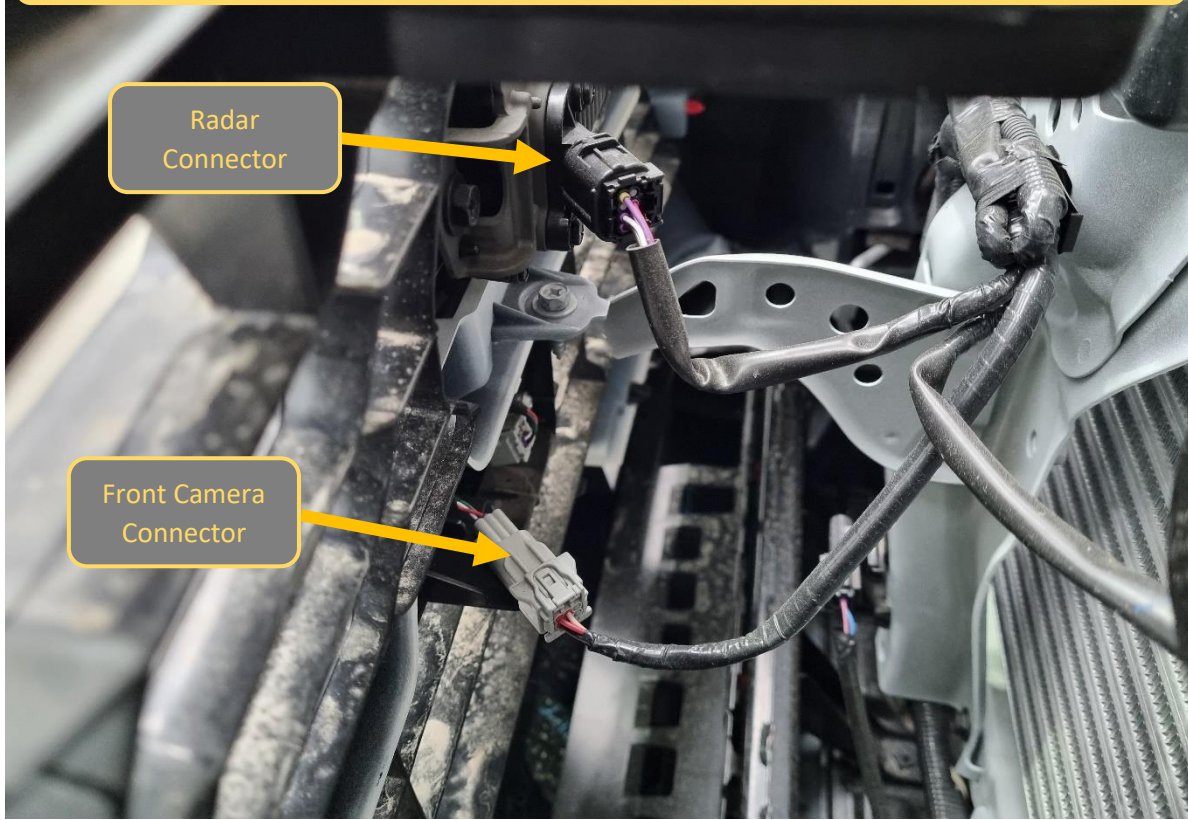
2021+ Models ONLY	
	
<ol style="list-style-type: none"> 6. Unplug the radar sensor module wiring connector, located on the back of the Toyota Badge / sensor. 7. If Equipped unplug the front camera wiring connector. 	<p style="text-align: center;">TOOLS REQUIRED</p>
	<p style="text-align: center;">FASTENERS</p>

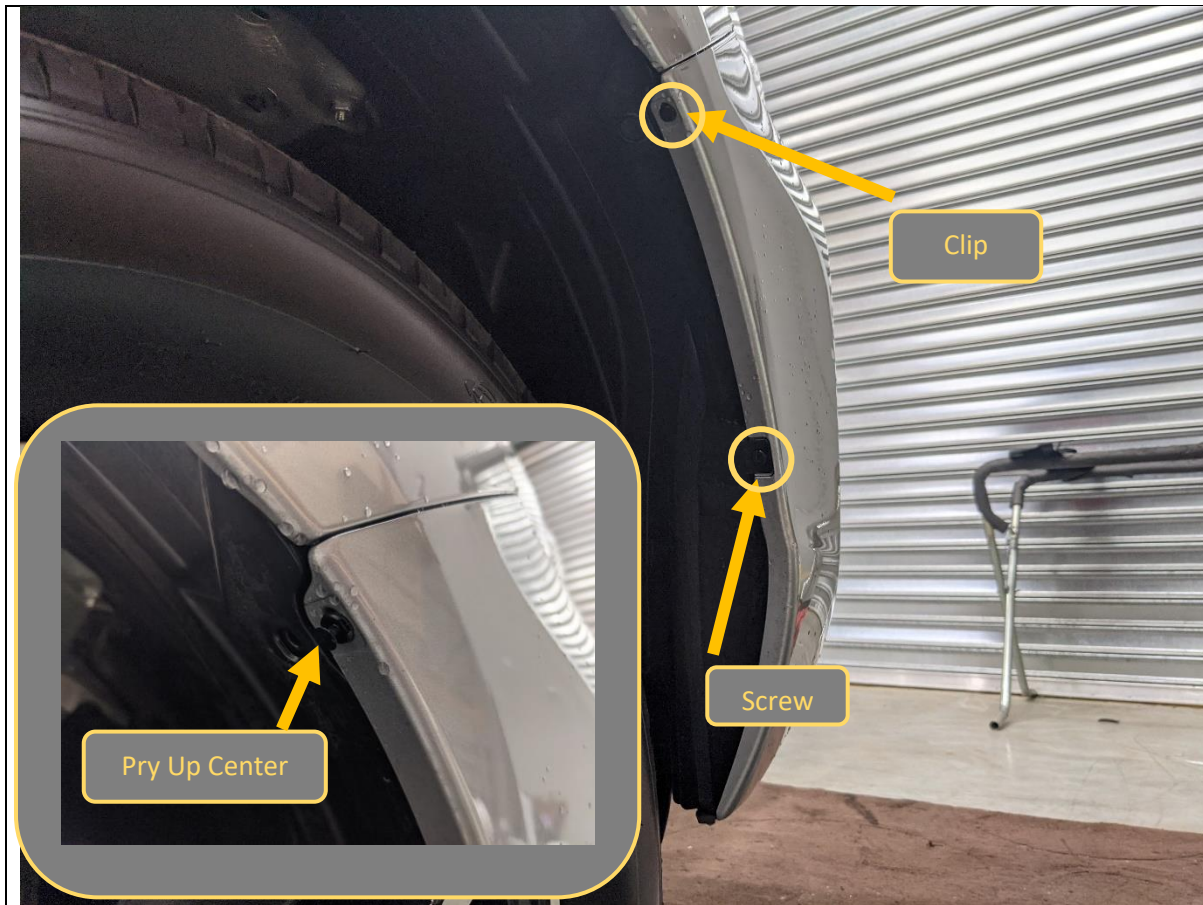

8. Remove the small screw and clip securing the bumper to the inner wheel arch liner.
9. Clip is a center release type. Pry up the center section to unlock then remove.

**TOOLS
REQUIRED**
8mm Socket
Trim Tool

FASTENERS

Factory Clip and
Screw



- 10. Remove the 3x 10mm head Screws securing bottom corner of bumper to inner wheel arch liner.
- 11. Complete on both sides of Vehicle

TOOLS REQUIRED

10mm Socket /
Spanner

FASTENERS

Factory Screws



12. Remove the 3x 10mm head Screws securing bottom center section of bumper to inner wheel arch liner.

TOOLS REQUIRED

10mm Socket /
Spanner

FASTENERS

Factory Screws



13. Remove the 2x 10mm Head/Phillips screws securing the bumper to crossmember.

These screws are located on the edge near the headlights behind the grille.

TOOLS REQUIRED

FASTENERS



14. Remove the bumper. Start by pulling from the outside where the bumper meets the wheel arch and work towards the center from both sides.

TOOLS REQUIRED

FASTENERS

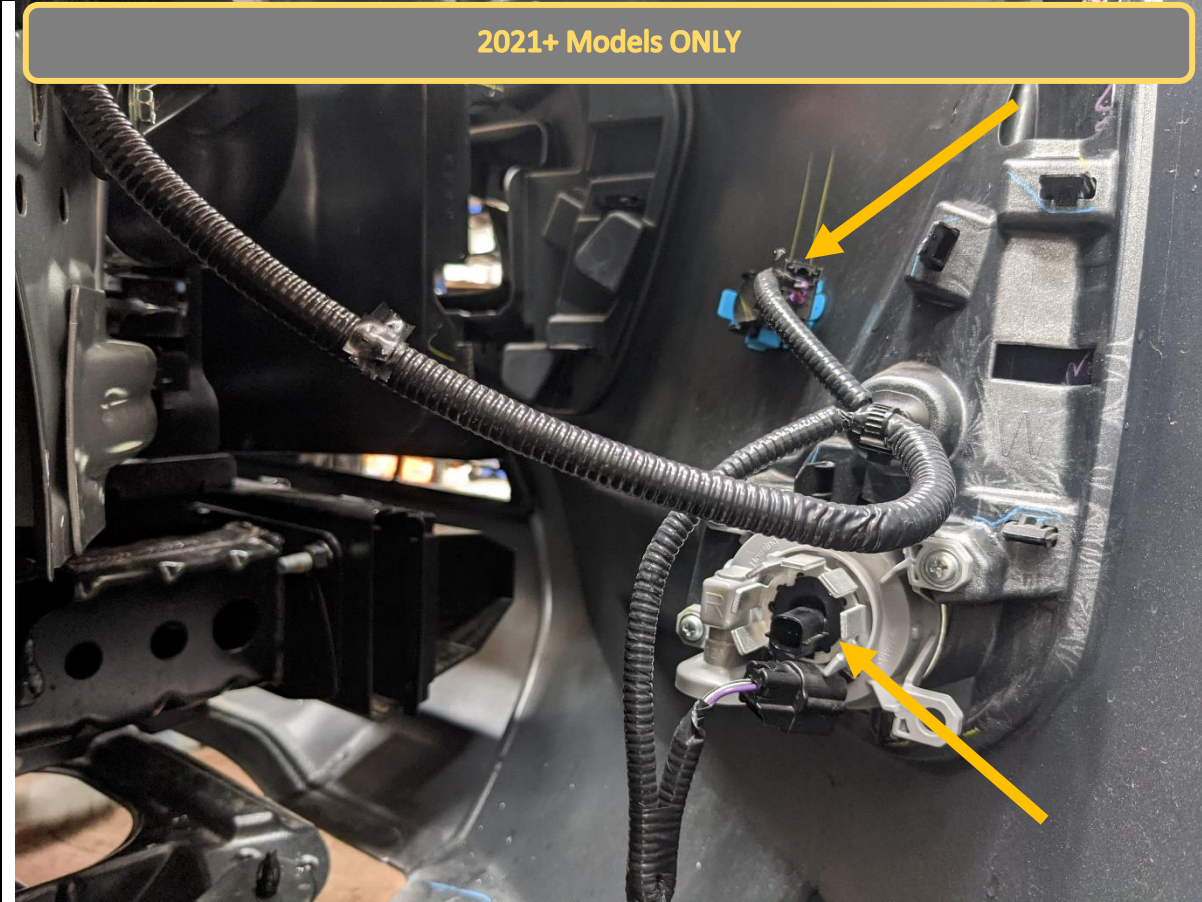

- 15. With assistance once the bumper is loose, unplug and release the parking sensor and fog light harnesses.
- 16. It is easiest to remove the sensor from the bumper by releasing the clips on back side then pushing sensor through the bumper, leaving it hanging on the cable.
- 17. This needs to be done on both sides of the vehicle.

TOOLS REQUIRED

FASTENERS

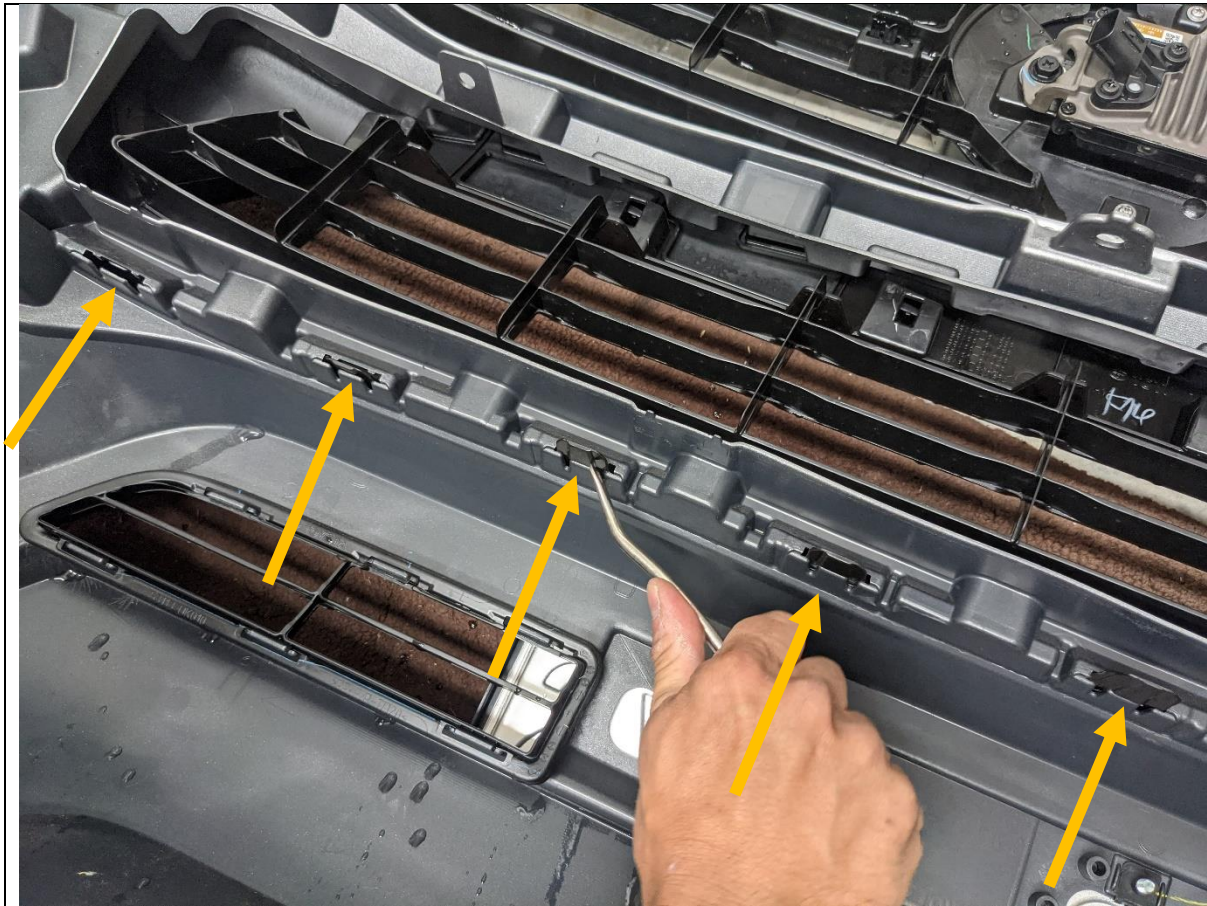

18. Once bumper is removed set aside on soft non marking surface or panel stand.

19. Release the bumper from the grille by releasing all the clips along the bottom of grille with a trim tool

TOOLS REQUIRED

Trim Tool

FASTENERS



20. Remove the front bumper support plastic fasteners using trim tool and Phillips screwdriver to pry whilst loosening as shown.
21. Remove the forward bolt using 10mm socket.
22. Remove the bumper supports using a trim tool.
23. Complete on both sides of the vehicle.

TOOLS REQUIRED
Trim Tool
Phillips Screwdriver
10mm socket

FASTENERS



- 24. Replace the forward bolt to re-secure the headlight to the wing.
- 25. Complete on both sides of the vehicle

TOOLS REQUIRED
10mm Socket

FASTENERS



26. Remove the plastic cover from the impact beam by strongly pulling in the direction shown to release it from the clips

TOOLS REQUIRED

FASTENERS

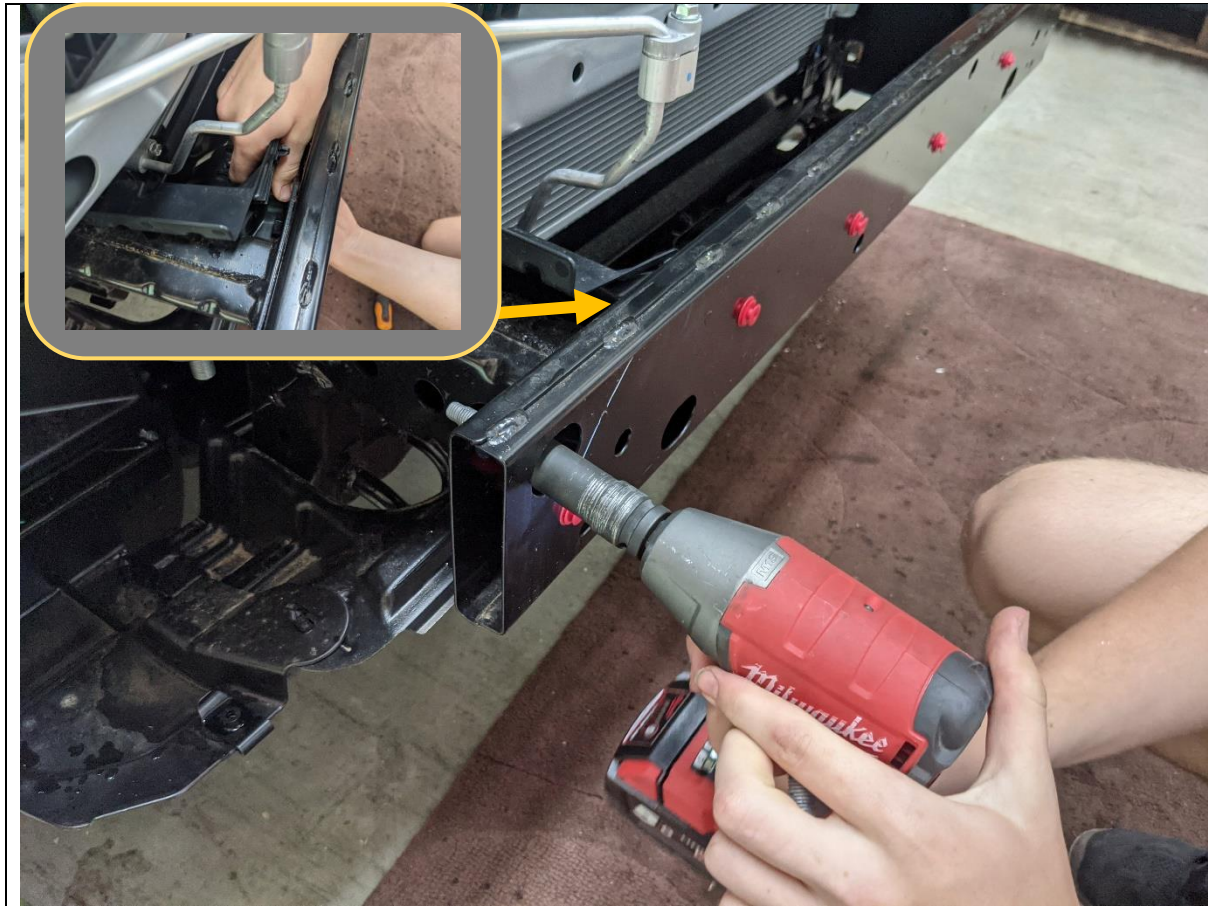

- 27. Remove the impact beam by removing the 4x Factory flange bolts securing it to the chassis rail
- 28. Release plastic clips on behind the impact beam in the air guides.

TOOLS REQUIRED

15mm Socket
Trim Tool

FASTENERS



29. Take impact beam off car and discard.

TOOLS REQUIRED

FASTENERS



- 30. Vehicle chassis rails should now be totally exposed as shown.
- 31. For light colored vehicles it is a good idea to paint the exposed panels beneath the headlight black, to ensure neat appearance once bar is fitted.

TOOLS REQUIRED

FASTENERS



32. Mark air guide on Right hand side of vehicle as shown in the above image.

33. Remove air guide from vehicle by releasing the 3x clips holding it to the chassis

TOOLS REQUIRED

Paint Marker

FASTENERS

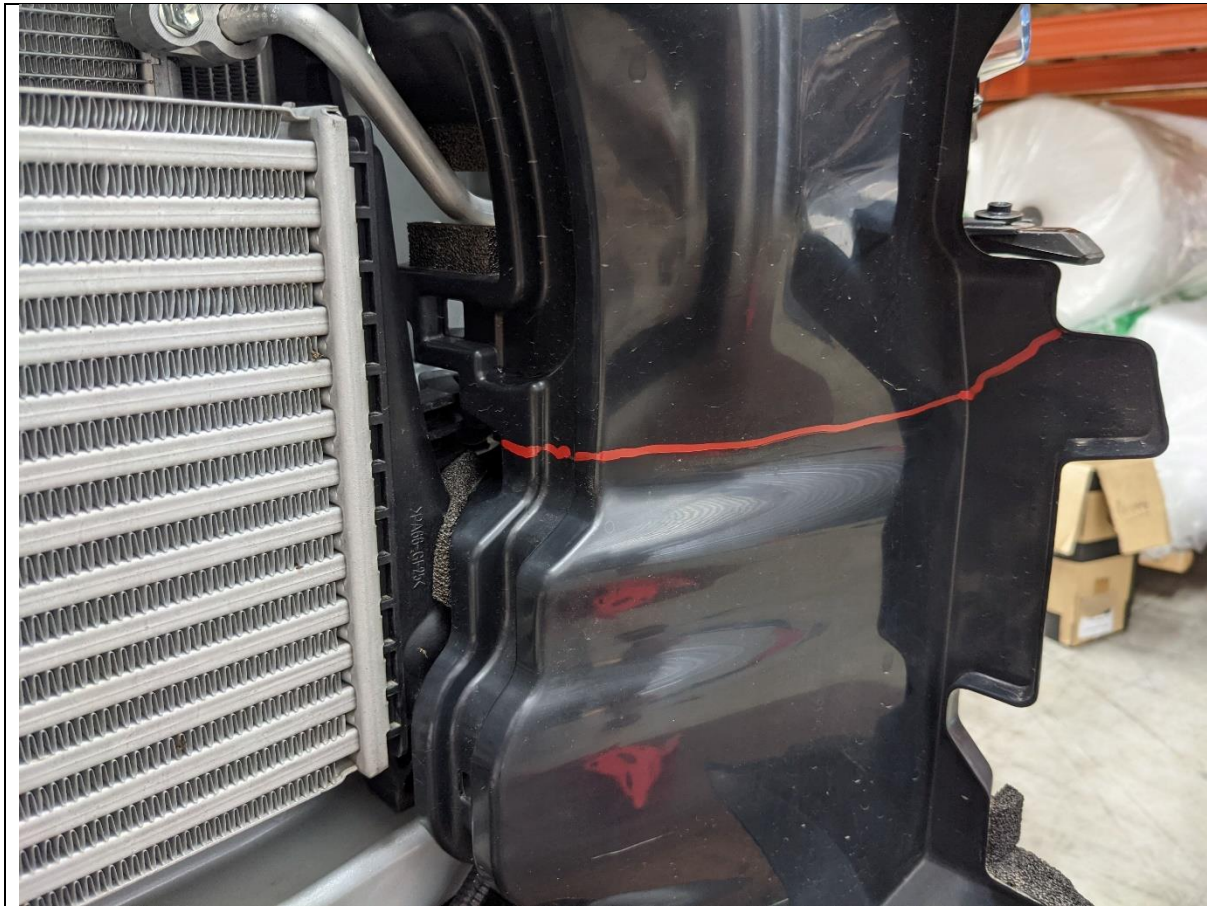

- 34. Mark air guide on Left hand side of vehicle as shown in the above image.
- 35. Remove air guide from vehicle by releasing the 3x clips holding it to the chassis

TOOLS REQUIRED

Paint Marker

FASTENERS

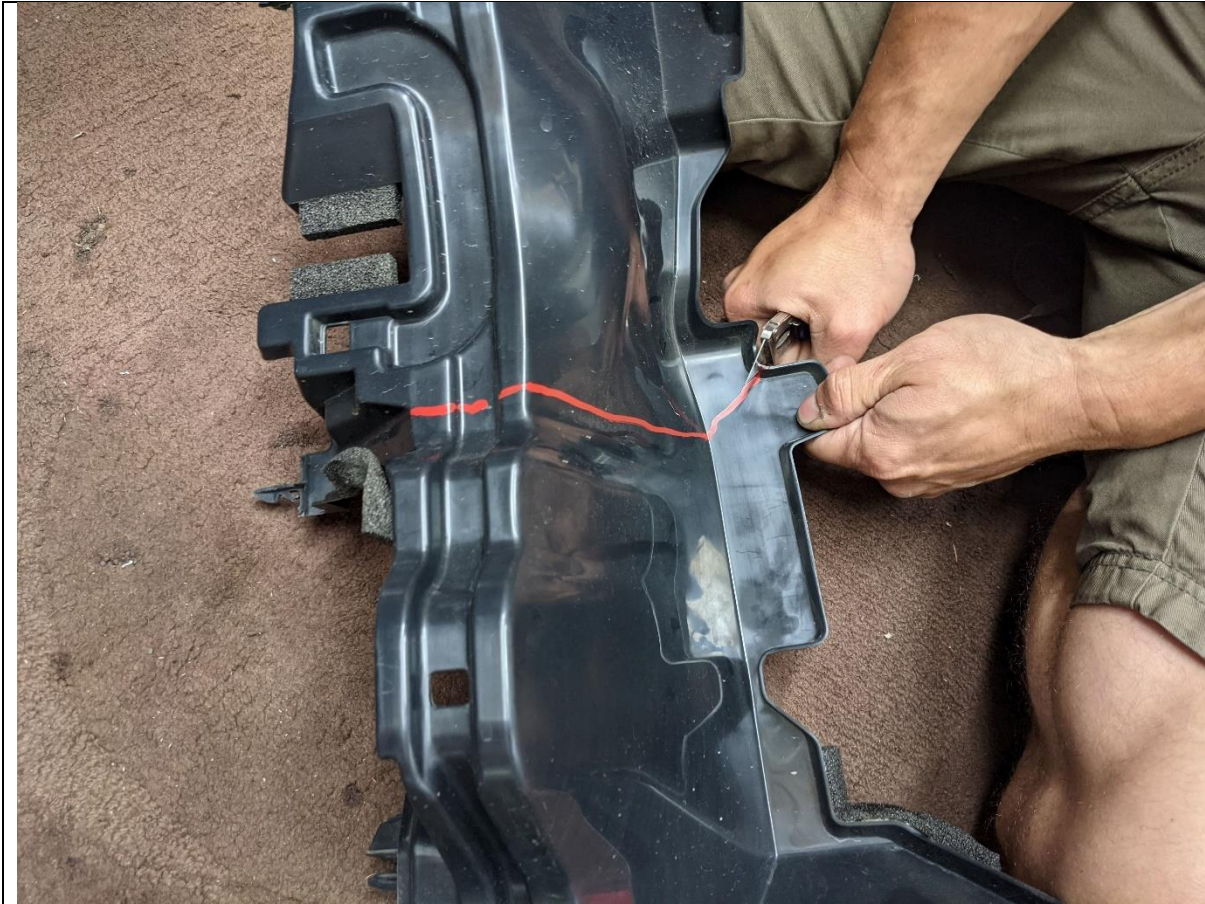

36. Trim the air guides along the lines marked, using a sharp utility knife or air hacksaw.

37. Re-Fit the top half of the air guides trimmed to the vehicle,

TOOLS REQUIRED
Utility Knife

FASTENERS



- 38. Take the chassis brace and fit loosely to the threaded M12 Fine pitch point in chassis, using M12x30x1.25 Bolt and flat washer.
- 39. Insert the Nut Plate into the chassis rail through the opening on the front of the chassis.
- 40. Secure the nut plate with M12x30 Standard pitch bolts and flat washers through the holes shown. Leave finger tight at this stage.
- 41. Repeat for other side of vehicle.

TOOLS REQUIRED

FASTENERS

- 1x M12x30x1.25p Bolt
- 2x M12x30x1.75p Bolt
- 3x M12 Flat washer.

PER SIDE

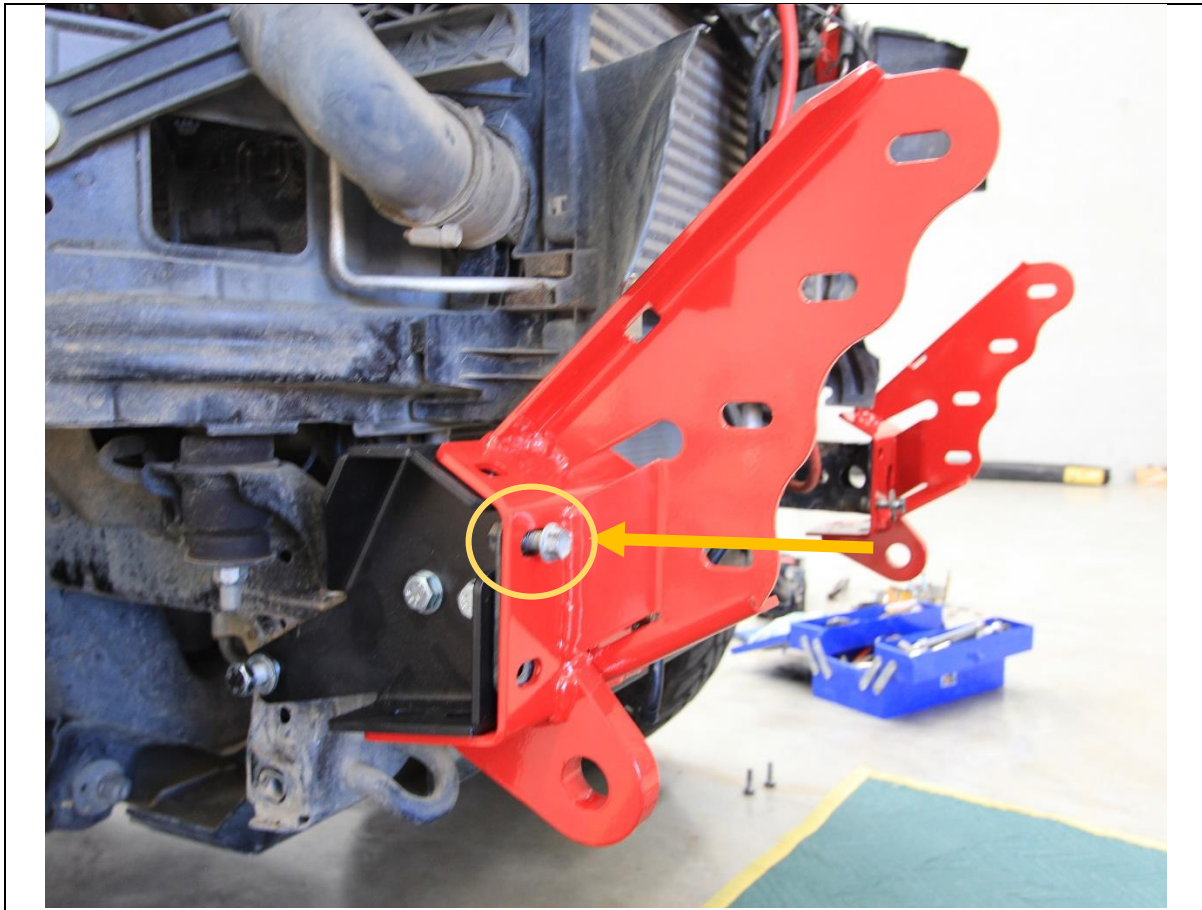

- 42. Fit the impact assembly to the end of the chassis rail.
- 43. Secure finger tight with the original M10 bolts in the threaded inserts in chassis.
- 44. Repeat for other side of vehicle

TOOLS REQUIRED

FASTENERS

2x Factory M10 flange bolt
per side.

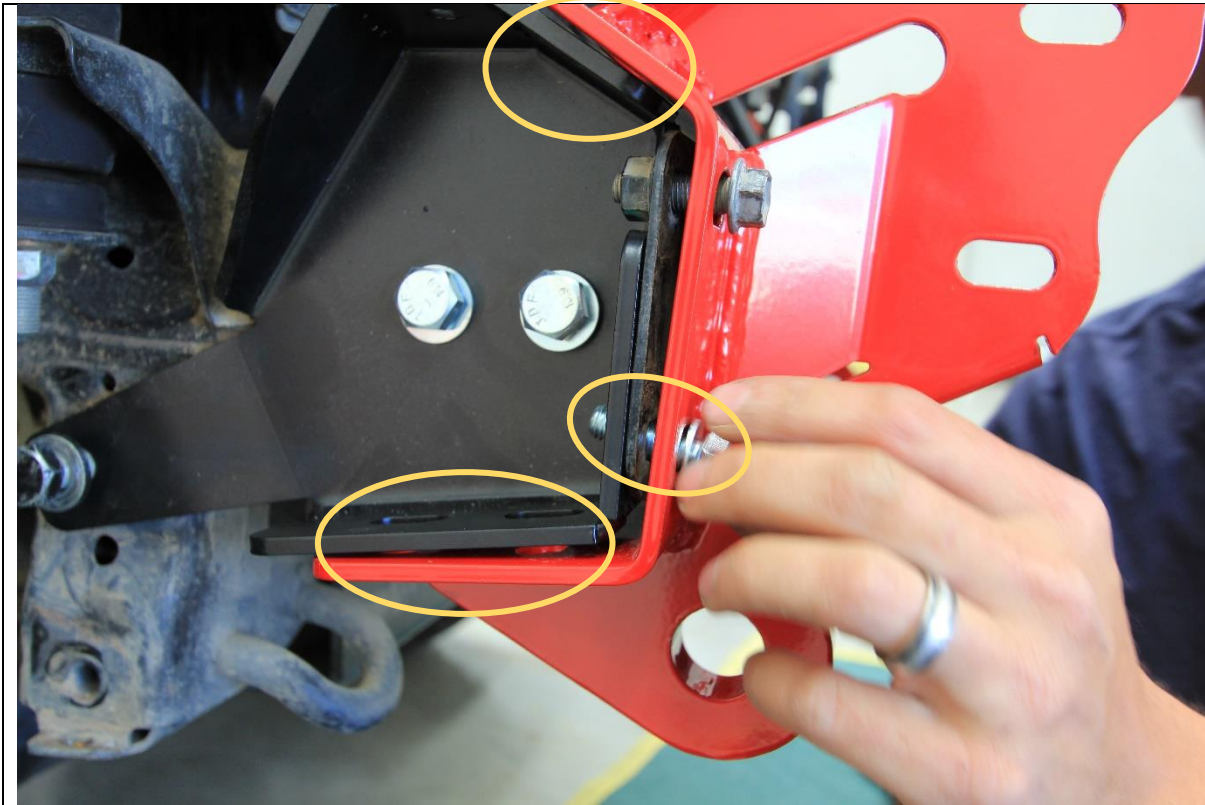

- 45. Fit remaining bolts to the impact assembly. 2x M10x30 Bolts, 4x Flat washers and 2x Nyloc nuts to front face.
- 46. Fit 2x M10x30 Bolts, 4x Flat washers and 2x Nyloc nuts to Bottom face.
- 47. Fit 1x M10x30 Bolt, 2x Flat washers and 1x Nyloc nuts to Top face.

TOOLS REQUIRED

FASTENERS

5x M10x30 Bolt
10x M10 Flat washer
5x Nyloc Nut

per side.

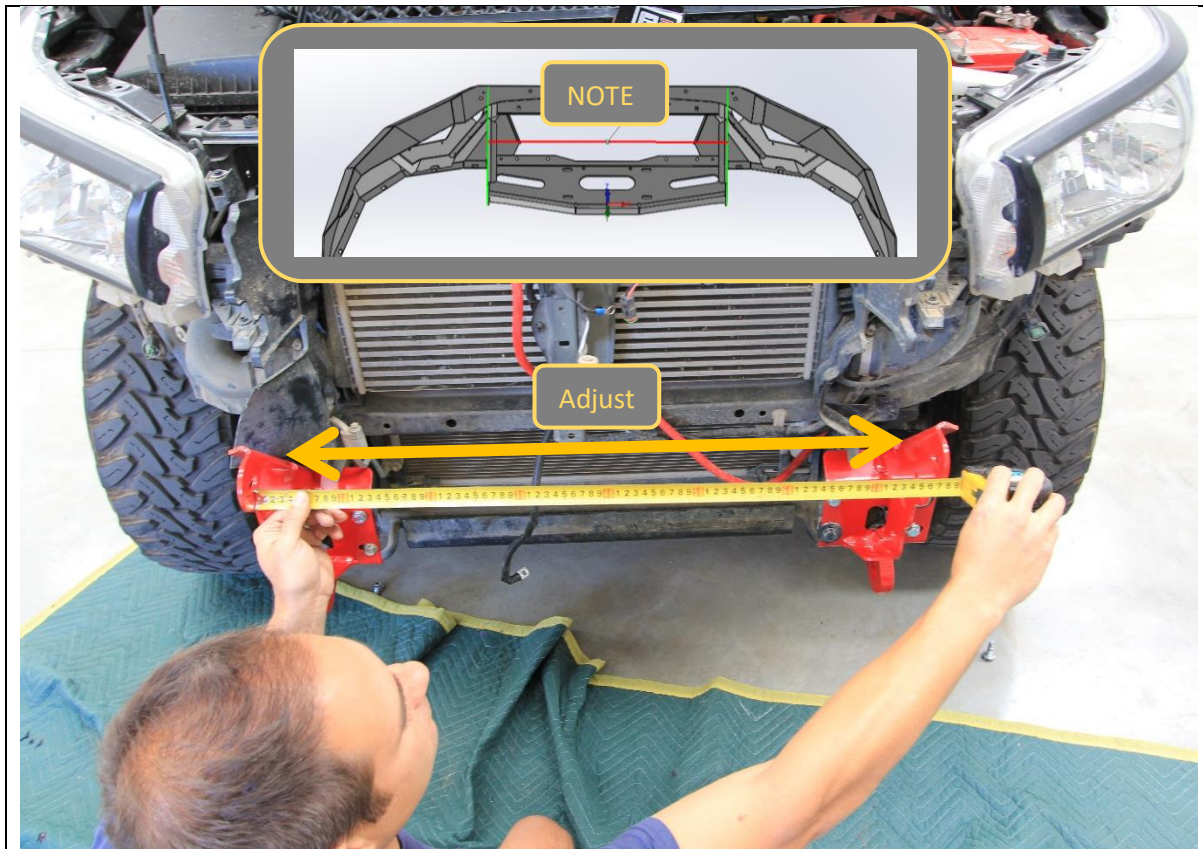

<p>48. Measure the distance between the outside faces of the uprights on the bar. Note this distance</p> <p>Bar uprights _____mm</p> <p>49. Adjust the distance between the impact assemblies to be approx. 1-2mm greater than the upright distance on the bar.</p>	<p>TOOLS REQUIRED</p> <p>Tape measure 16mm Spanner 16mm Socket</p>
<p>50. Tighten bolts on the impact assemblies and re-check distance. Loosen and adjust as required until the distance between mount when mounts are tight is correct.</p>	<p>FASTENERS</p>



51. Remove the 3x Screws securing the fog lights to the bumper, then remove the fog light from the bumper

TOOLS REQUIRED
Screwdriver

FASTENERS
Factory Screws

2021+ Models ONLY	
	
<p>52. Fit the parking sensors to the supplied F-0032 Parking sensor housings. Ensure the sensor fully clips into the housing and is straight.</p> <p>53. Ensure the locating rib in the sensor is aligned with the slot on the sensor housing</p>	<p style="text-align: center;">TOOLS REQUIRED</p>
	<p style="text-align: center;">FASTENERS</p>



2021+ Models ONLY

54. Break the bulb of the supplied Primer 94 ampule to activate the primer dispensing.
55. Apply Primer 94 to all areas adjacent to the parking sensor locations, on both the bar and the sensor housings. Wait at least 5 minutes for primer to cure before adding tape.
56. Apply supplied VHB tape pads to all sensor housings as shown in the inset photo.
57. Dry fit sensors to bar to check if enough room to connect loom.
58. Remove backing and adhere sensors in position in bar. Apply pressure for 10-30sec after positioning for best adhesion.

TOOLS REQUIRED

- FASTENERS**
VHB Tape pads
Primer 94 Ampule

2021+ Models ONLY

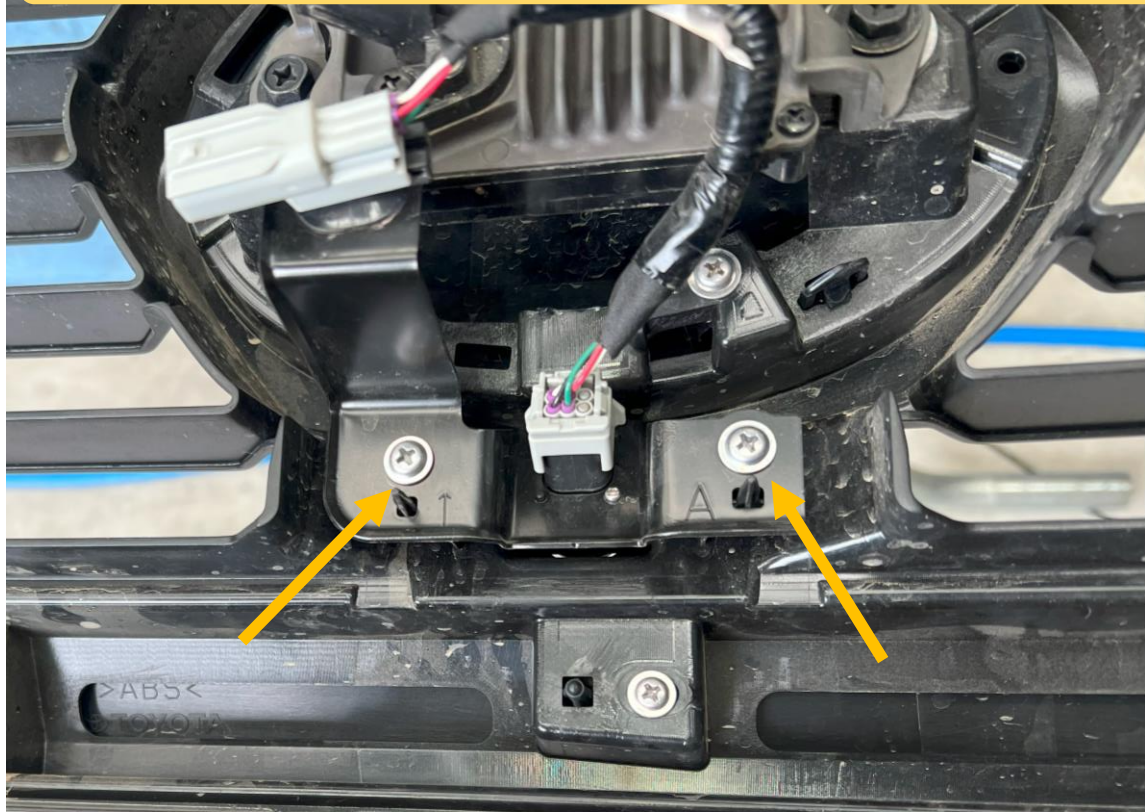

- 59. If fitted to MY21-23 you can choose to relocate the front camera to the fairlead mesh panel. This will improve the camera field of view.
- 60. If fitted to MY24+ you NEED to relocate the front camera to the fairlead mesh panel. The factory camera position is lower on these models and bar will almost completely obstruct camera view if left in OE location.
- 61. If relocating the camera remove module from the grille with 2x Phillips head screws.
- 62. Unclip wiring harness from bracket but leave the camera attached to the bracket.

TOOLS REQUIRED
Trim Tool

FASTENERS

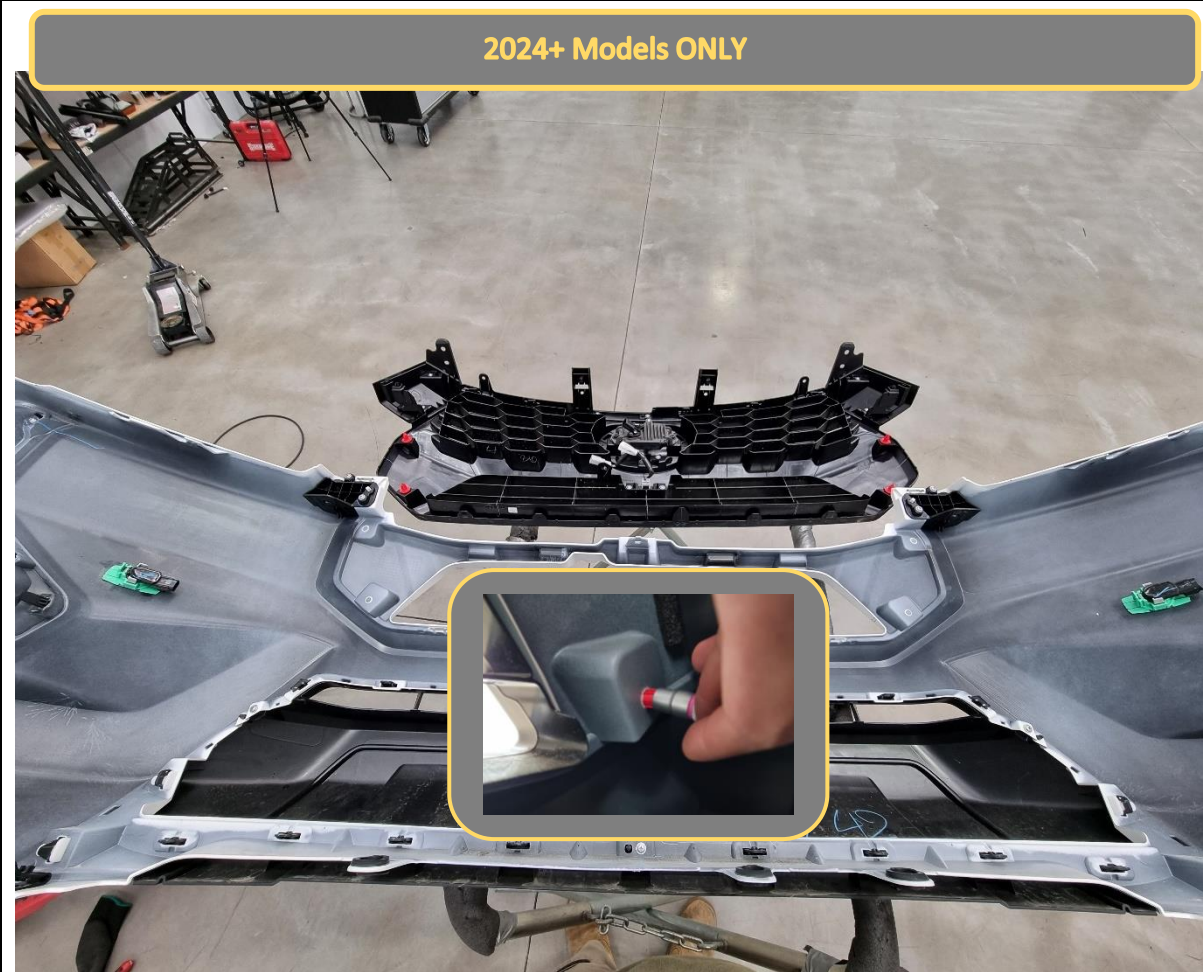

63. Separate grille from bumper by releasing the 4x Red clips. It can be helpful to push the clips from behind using a small socket to avoid marking the grille.

TOOLS REQUIRED
Trim Tool
Small Socket

FASTENERS

2024+ Models ONLY

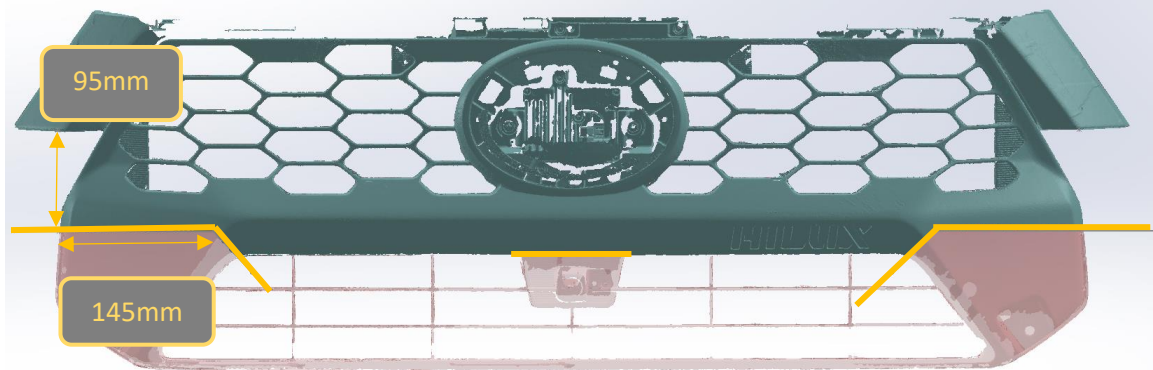

- 64. Apply masking tape over cut areas.
- 65. Mark out the grille cut as denoted by lines in image. Ensure it is symmetric, reposition the tape if required. Green area is to be retained, red to be removed.
- 66. Using angle grinder or air hacksaw, cut along edge of the tape.
- 67. Cut all vertical slats just below horizontal bar to allow the grille to separate into two pieces.

TOOLS REQUIRED
 Angle Grinder or Air
 Hacksaw
 Masking Tape
 Marker

FASTENERS

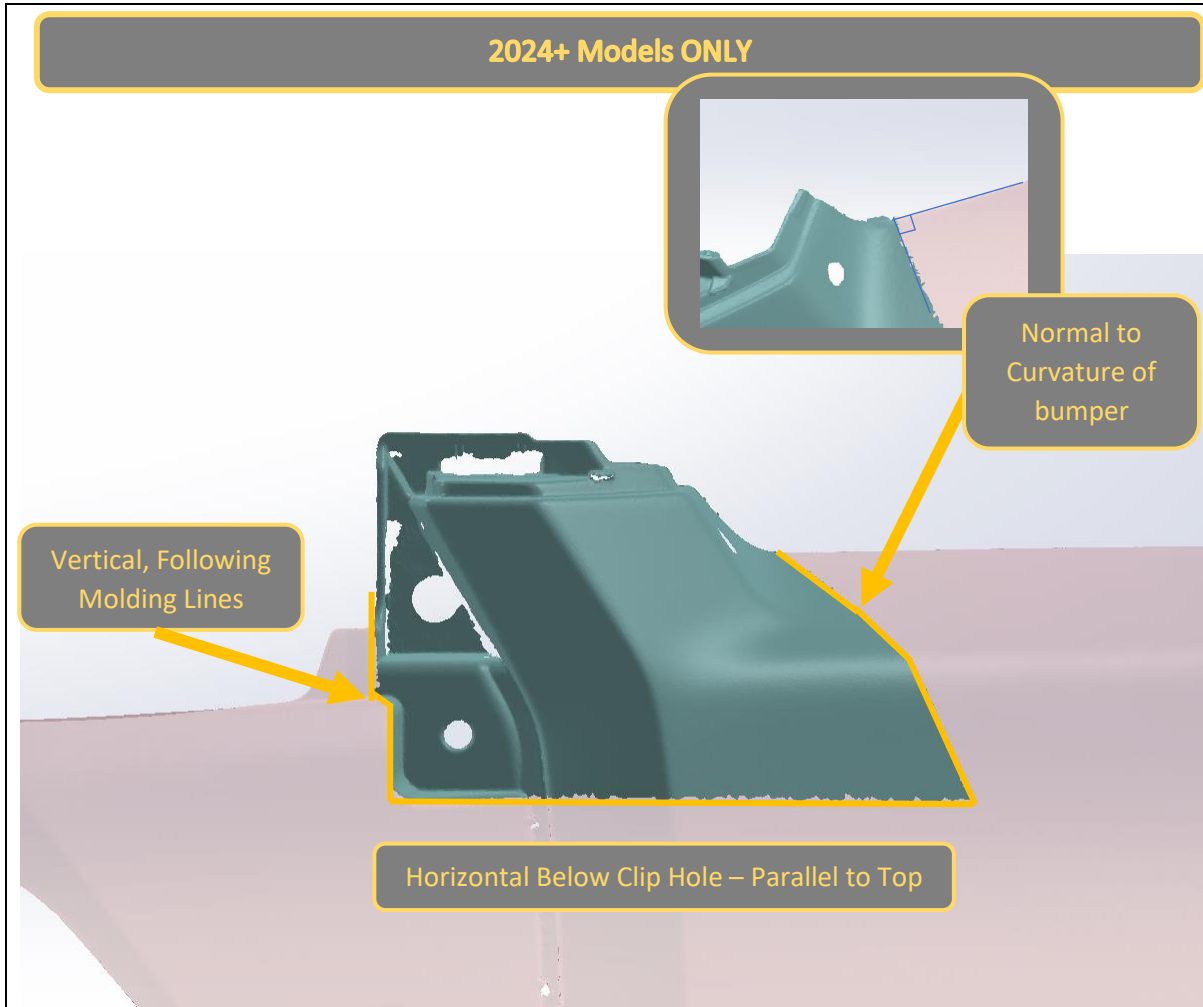

<p>68. On the bumper, apply masking tape over cut areas.</p> <p>69. Mark out the Bumper cut as denoted by lines in image. Ensure it is symmetric, only 1 side is shown in image, reposition the tape if required.</p> <p>Green area is to be retained, red to be removed.</p>	<p>TOOLS REQUIRED Angle Grinder or Air Hacksaw Masking Tape Marker</p>
<p>70. Using angle grinder or air hacksaw, cut along edge the marked lines</p>	<p>FASTENERS</p>

2024+ Models ONLY



71. Refit the cut bumper segments to the trimmed portion of the grille, re using the factory molded clip at the top and red clip below.

72. The grille is now ready for refitment to the vehicle.

TOOLS REQUIRED

FASTENERS

2021-2023 Models ONLY



- 73. Place masking tape on the grille, in the location shown just below the center horizontal bar.
- 74. The Mark out the grille cut as denoted by lines in image. Ensure it is symmetric, reposition the tape if required.

TOOLS REQUIRED
Masking Tape

FASTENERS



- 75. Using angle grinder or air hacksaw, cut along edge of the tape.
- 76. Cut all vertical slats just below horizontal bar to allow the grille to separate into two pieces.

TOOLS REQUIRED
Angle Grinder or Air
Hacksaw

FASTENERS

2018-2020 Models ONLY



77. Using Similar technique as explained for 2021+ models cut the grille along the top edge of the horizontal bar below the badge, as shown in the above image.

TOOLS REQUIRED
Angle Grinder or Air
Hacksaw

FASTENERS

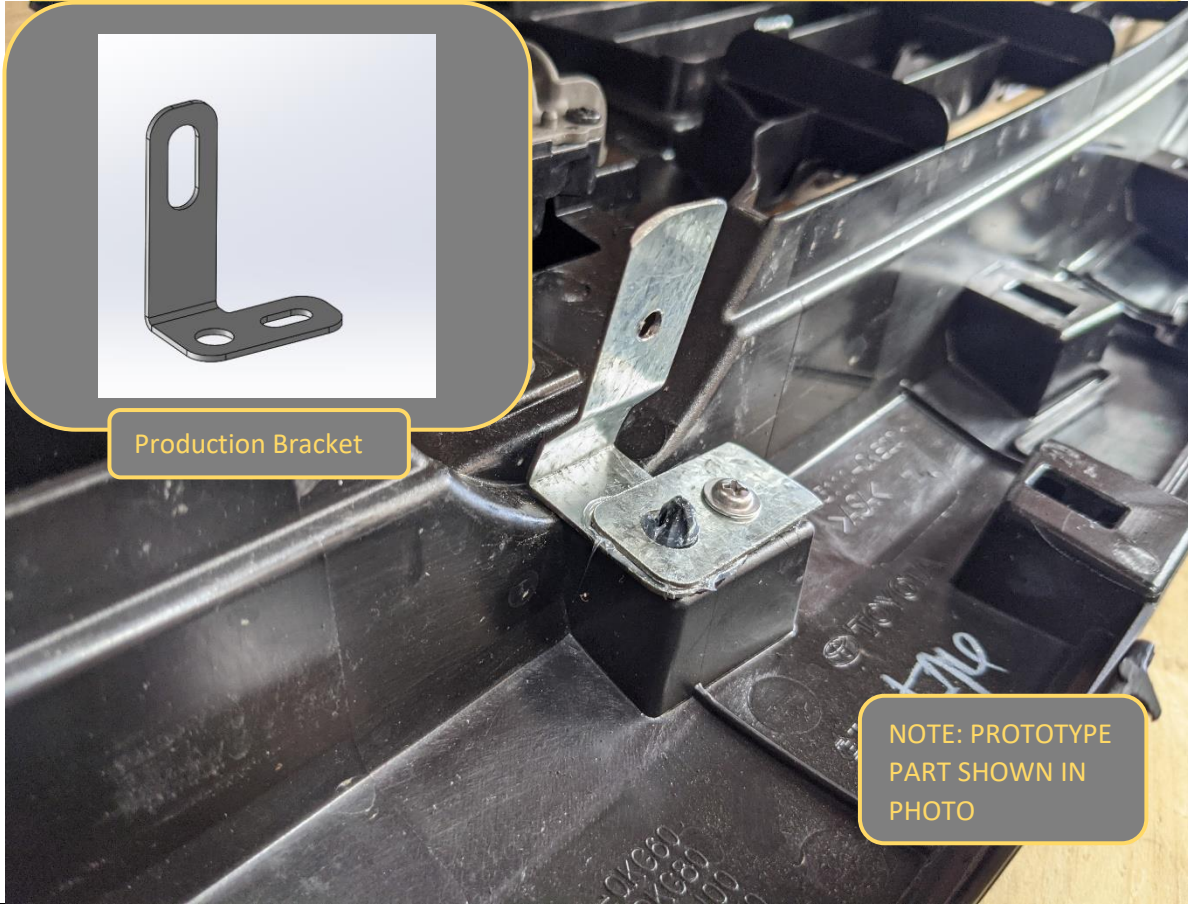
2021-2023 Models ONLY	
	
<p>78. Fit the bottom grille support bracket to the middle of the top section of the grille, under the adaptive cruise radar sensor.</p> <p>79. Remove the existing Philips head screw, then re fit with bracket in place.</p>	<p>TOOLS REQUIRED Flat bladed screwdriver</p>
	<p>FASTENERS 6x M6 Cage Nuts</p>

2015-2018 Models ONLY

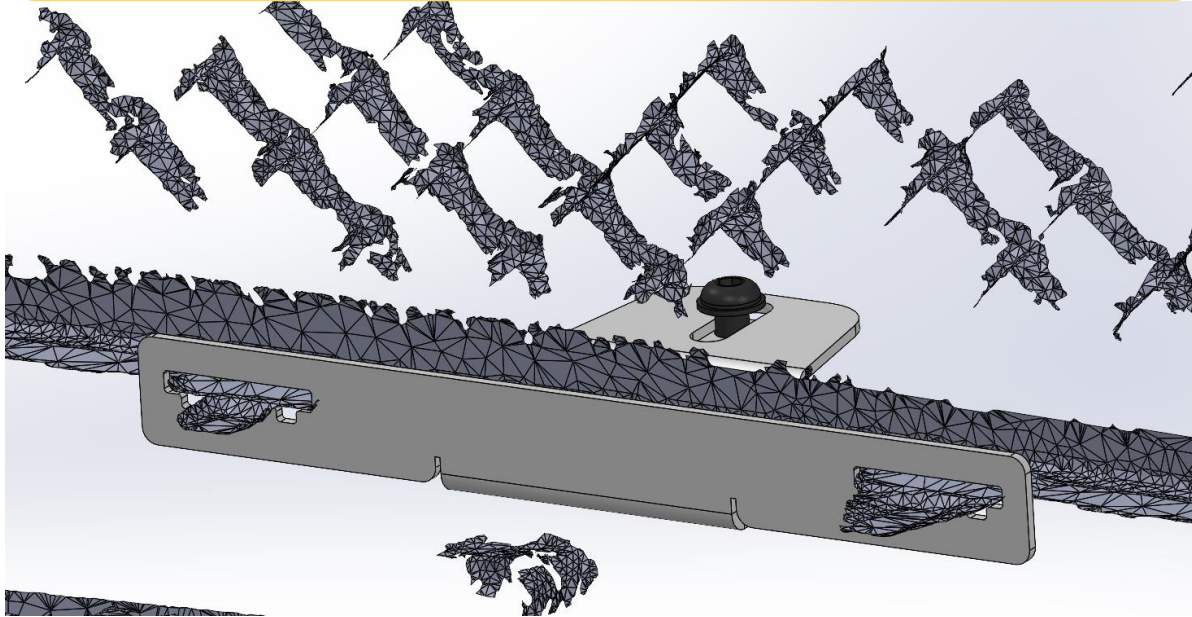

80. Clip the grille support bracket into the tabs on the back side of the grille.

TOOLS REQUIRED

FASTENERS

2021+ SR5 Models ONLY

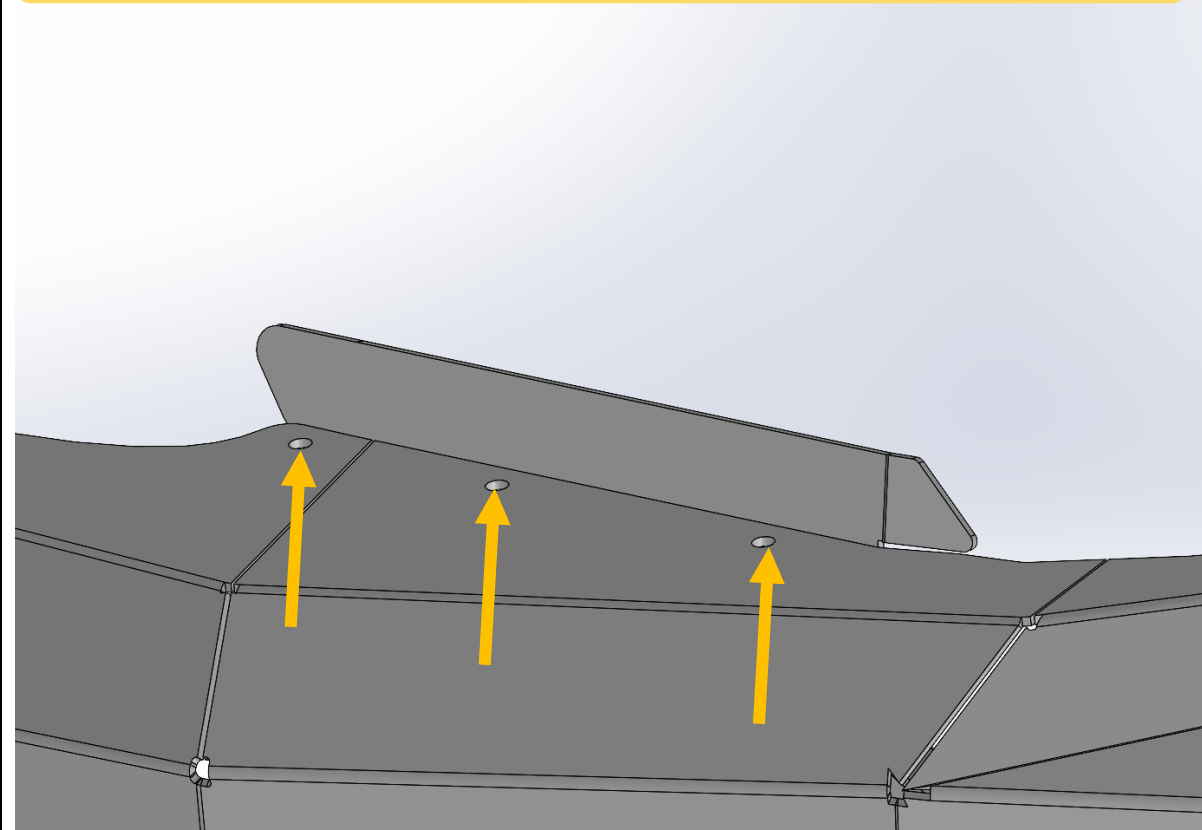

81. Fit the plastic infill panels to the bar, using supplied M6x16 Black Button head bolts, Black washers, and flange nuts.

TOOLS REQUIRED
4MM hex key

FASTENERS
3x M6x16 Black button head
3x M6 Black washer
3x Flange Nut

Per side

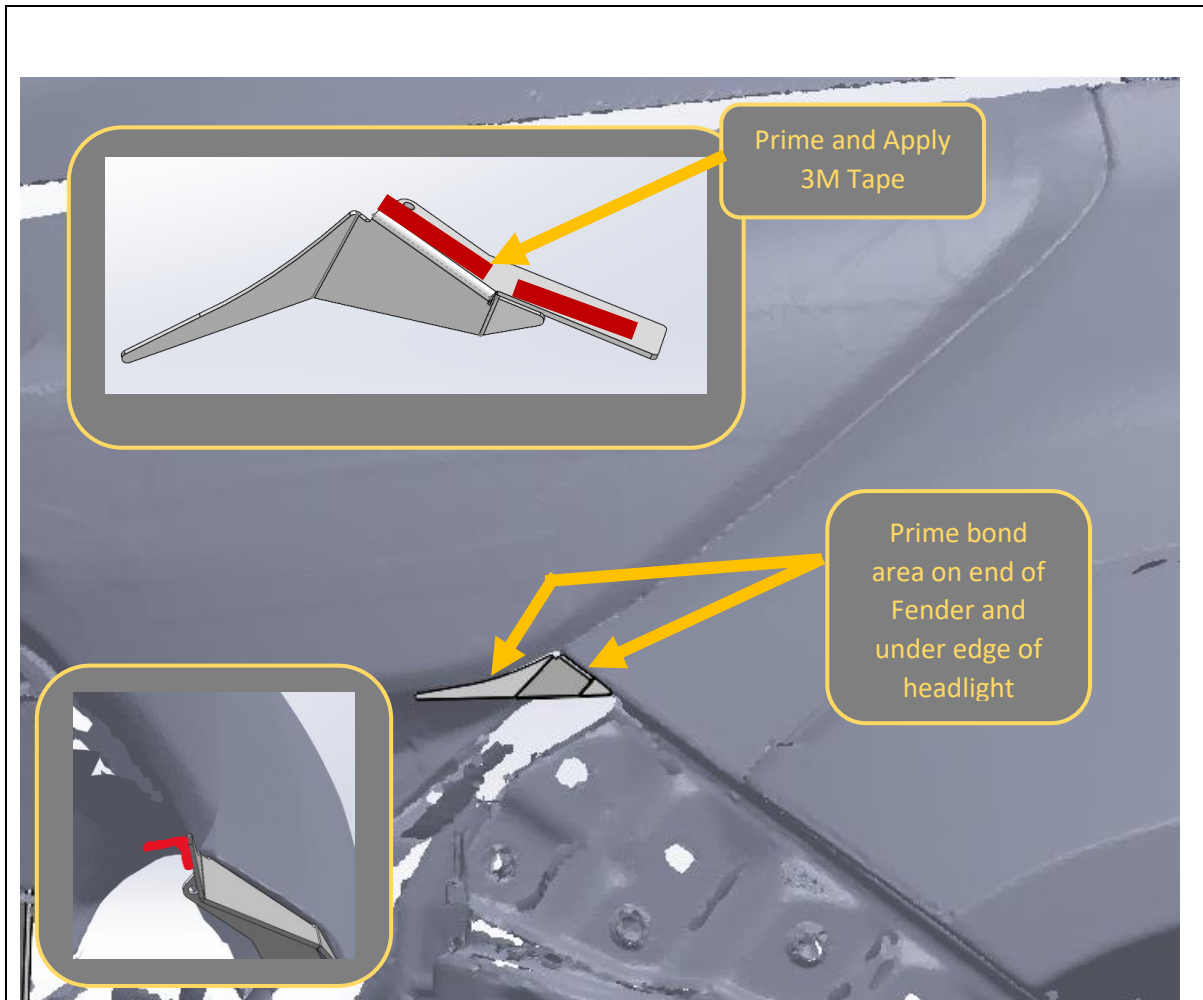

- 82. Using 3M primer stick from parking sensors, apply primer to end of fender panel and small headlight infill in the bonding area as shown.
- 83. Cut and apply length of 3M tape to the small headlight infill panel as shown in the inset image.
- 84. Fit the headlight infill using the 3M tape. Apply pressure for 10-30 seconds to ensure strong bond.
- 85. Use final tape pad to secure the backside edge of the infill to the underside of the headlamp.

TOOLS REQUIRED

- 3M Primer 94
- 3M Tape

FASTENERS

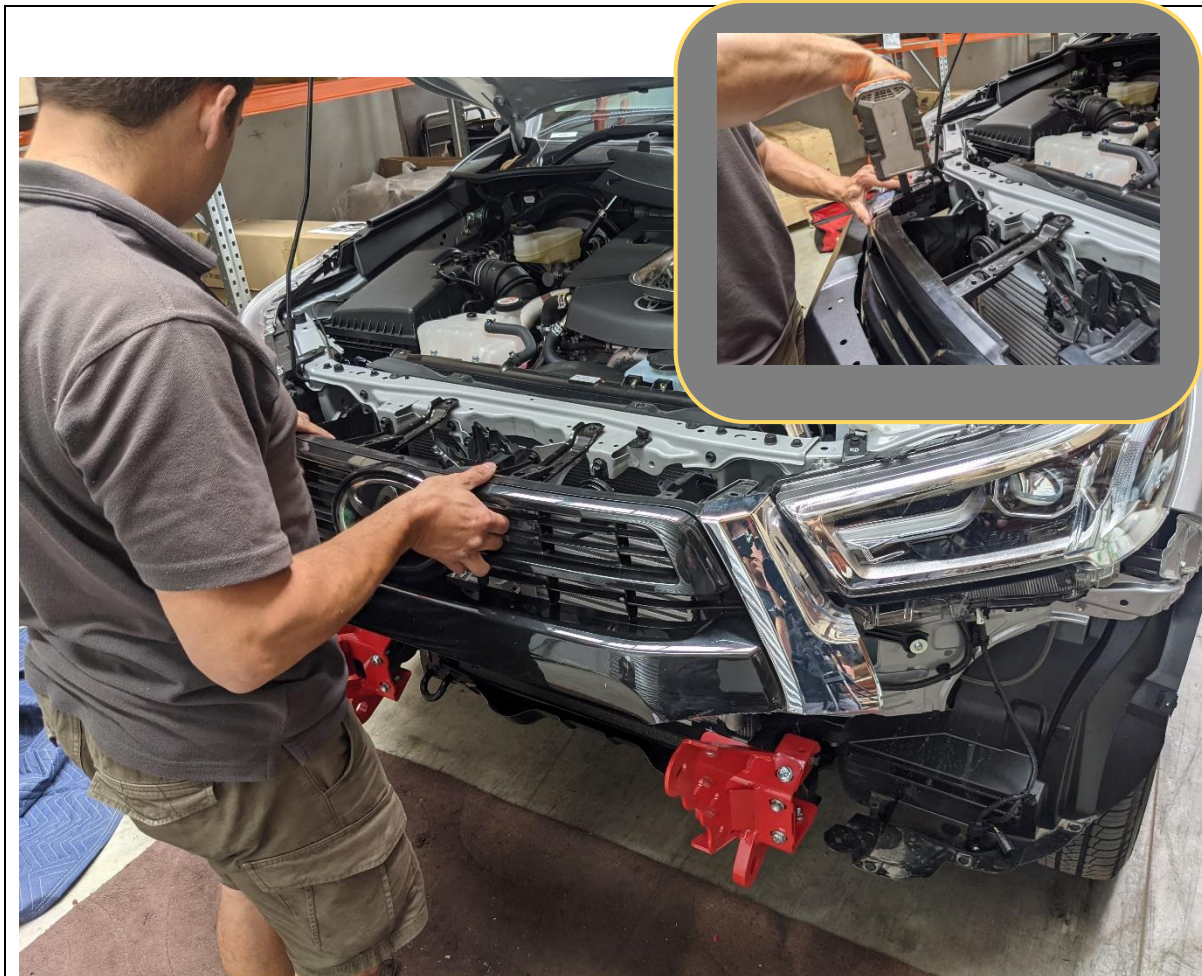

- 86. Re fit the trimmed section (18+) of the grille to the vehicle. For 15-18 Models just refit grille as removed from bumper.
- 87. Secure top of grille using original 10mm Fasteners.
- 88. Secure the grille support bracket to the plastic insert in the using a self tapping Phillips screw (15-23 Models)
- 89. 24+ Models only, Secure the trimmed section of the bumper (clipped to the grille) to the original support locations in the corners using Original Fasteners

TOOLS REQUIRED
10mm Socket
Phillips screwdriver

FASTENERS
Re-Use OE Fasteners

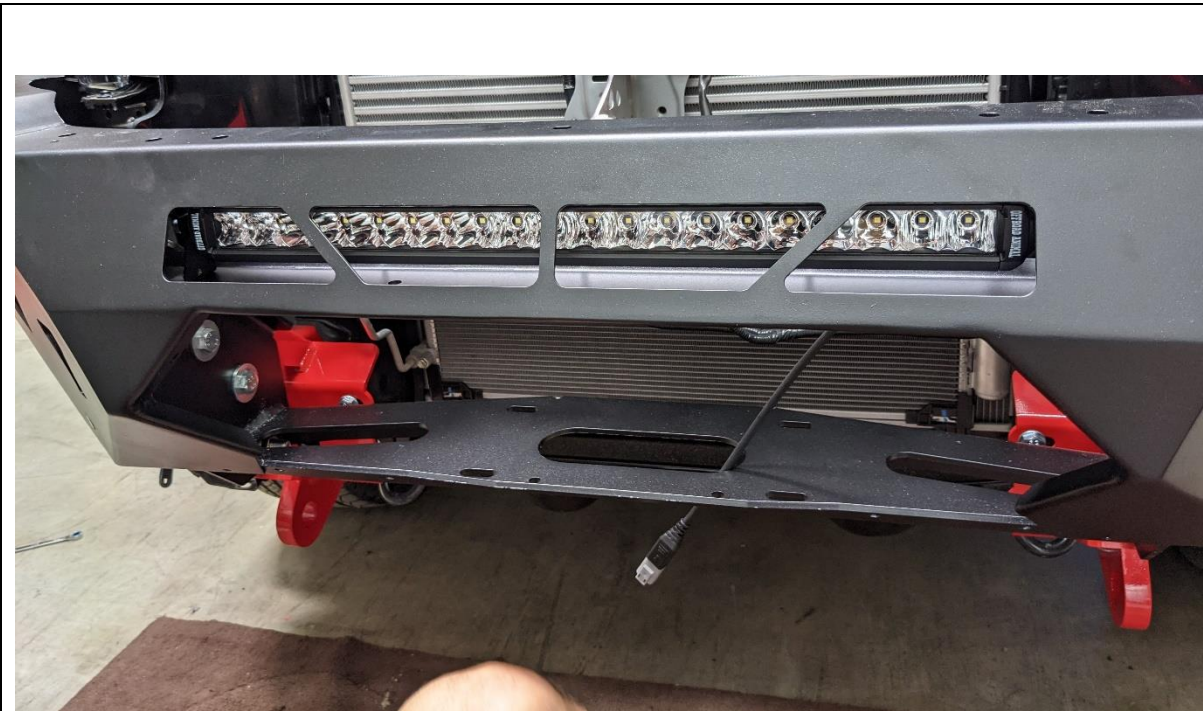

90. If fitting a light bar to the center section of the bar, do so at this stage, before fitting the bar to the car.

91. Use hardware provided with the Lights to fit to the bar.

TOOLS REQUIRED
Flat bladed screwdriver

FASTENERS
6x M6 Cage Nuts



92. Insert cage nuts to square slots in bottom of wings.
Seat cage nut against one edge of slot then push other
edge in with flat bladed screwdriver.

TOOLS REQUIRED
Flat bladed screwdriver

FASTENERS
6x M6 Cage Nuts



- 93. With assistance, from either another person or mechanical lifting aid such as a lift trolley, offer the bar up to the mounts.
- 94. Secure the bar to the mounts using single M12x30 Bolt 2x M12 Heavy Duty flat washers and M12 Nyloc Nut per side
- 95. Loosely fit the other 3x M12x30s Bolt 6x M12 Heavy Duty flat washers and 3xM12 Nyloc Nuts per side.

TOOLS REQUIRED
Lifting trolley

FASTENERS
8x M12x30 Bolt
16x M12 HD Washer
8x M12 Nyloc Nuts



96. Align the bar with the body. Aim for 15-20mm clearance between the wing and body.

IMPORTANT: It is the installers responsibility to ensure clearances are set so that no part of the bar touches the vehicle. Remember that body is rubber mounted and will move relative to bar in use.

NOTE: The appearance will differ slightly from the above image due to the new body mounted infill

97. With assistance, Hold the bar in position and tighten all the Bar to mount bolts, using 19mm socket and spanner.

An Electric Impact wrench makes this process much easier.

TOOLS REQUIRED

- 19mm socket
- 19mm spanner

FASTENERS



- 98. If fitting a winch to the bar, do so at this stage. Follow the winch manufacturer's instructions.
- 99. The winch mounts feet down and is inserted through the front opening of the bar.
- 100. Most winches will fit underneath the triangular cross brace. Warn Zeon 10 winches will need to trim this cross brace to gain sufficient clearance.

TOOLS REQUIRED
Refer to winch Instructions

FASTENERS
Refer to winch Instructions



- 101. If relocating the camera module, fit to the center mesh panel, using the original bracket, and supplied M6x16 button head screws, flat washers, and flange nuts.
- 102. If fitting winch, attach fairlead to center mesh panel using bolts supplied in winch fitting kit.
- 103. Fit number plate flip to mesh panel using M6x20 Hex bolt, Flat washer, and flange nut, supplied in number plate flip kit.

TOOLS REQUIRED
10mm Socket
4mm hex key

FASTENERS
2x M6x20 Hex Bolt
4x M6 Flat washer
4x M6 Flange Nut
2x M6x16 Black Button Head

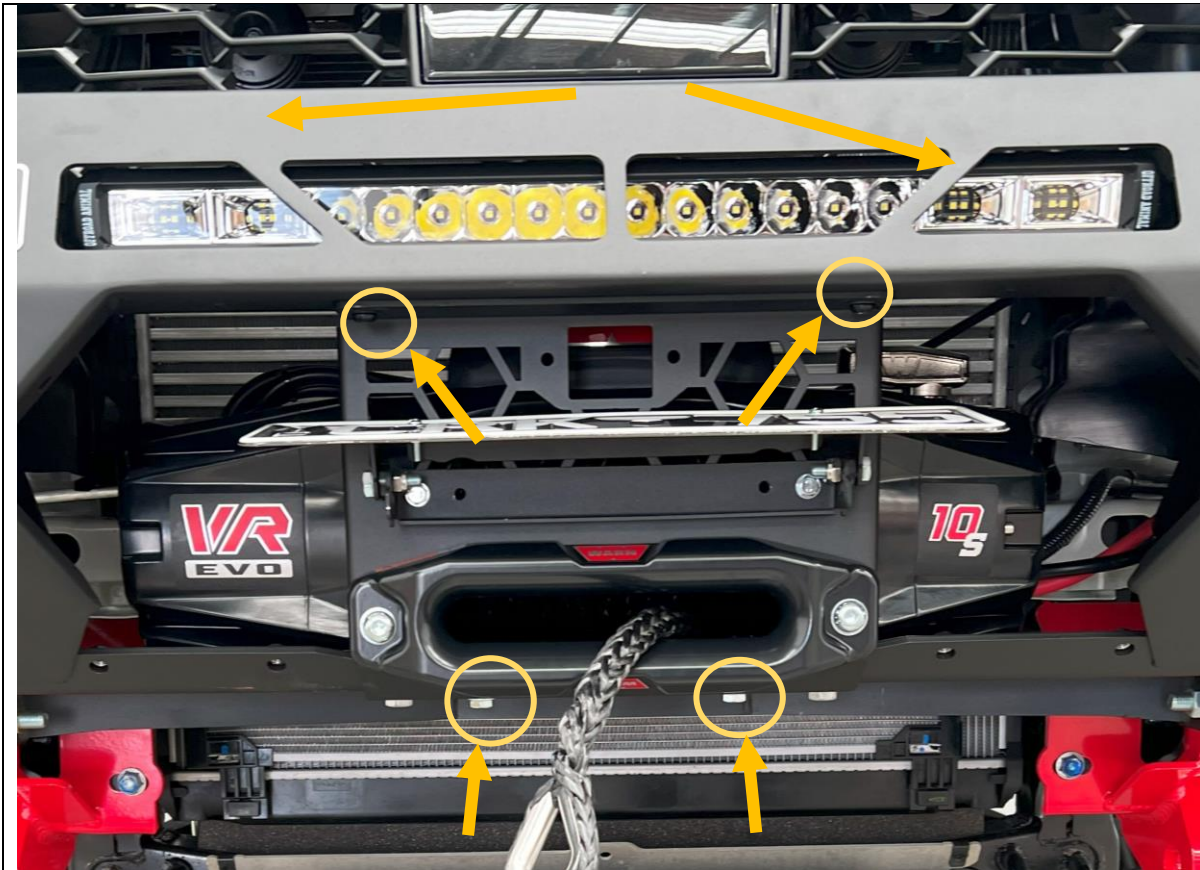

104. Fit Mesh panel to the bar. Ensure winch cable is fed through fairlead.

Secure with 2x M8x16 Black Button Head Screws, M8 Flat washer int nuts in gusset at top and 2x M8x20 Hex Bolts M8 Flat washer and M8 Flange nuts at Bottom.

105. If equipped re-connect camera module harness.

TOOLS REQUIRED

- 5mm Hex Key
- 13mm Spanner
- 10mm spanner

FASTENERS

- 2x M8x16 Button Head
- 2x M8x20 Hex Head
- 4x M8 Black Flat Washer
- 2x M8 Flange Nut



<p>106. Fit the side mesh panel to the bar, using only the top and side points at this stage. Secure with 2x M6x16 Black Button head, bolts, Black M6 Flat washer and flange nut.</p>	<p>TOOLS REQUIRED 4mm Hex Key 10mm Socket 10mm Spanner</p>
<p>107. Repeat for other side of vehicle.</p>	<p>FASTENERS 4x M6x16 Button Head 4x M6 Black Flat Washer 4x M6 Flange Nut</p>
<p>108. Fit Number Plate to number plate flip, using M5 fasteners supplied with number plate flip</p>	

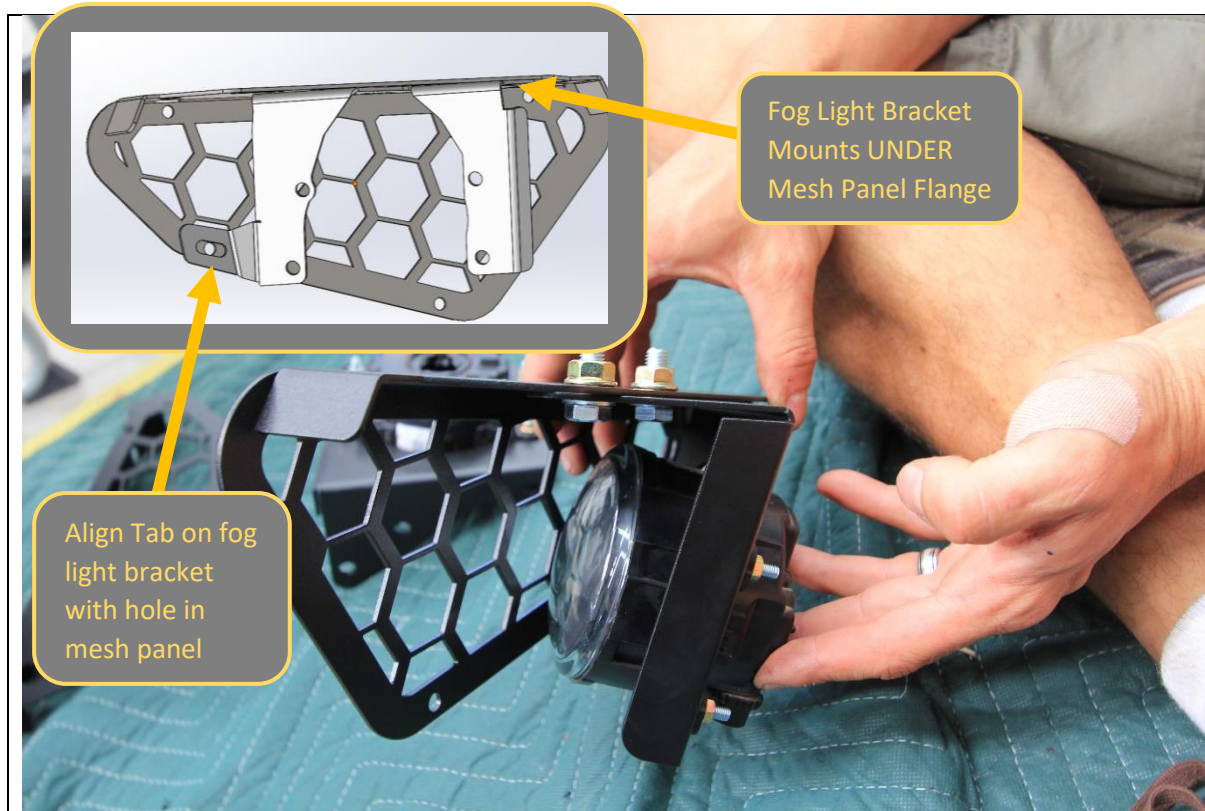

<p>109. If re-fitting factory fog lamps, fit the fog lamps to the supplied fog lamp brackets using the M6x16 screws and Flange nuts provided.</p>	<p>TOOLS REQUIRED 4MM Hex Key 10mm Spanner 13mm Spanner</p>
<p>110. Fit the fog lamp brackets, to the light mesh panels using 2x M8x20 Hex head bolts,</p> <p>111. If fitting own lamps in light mesh, fit now using slots on panel, and hardware provided with lights.</p> <p>112. Repeat for both sides of vehicle.</p>	<p>FASTENERS (if fitting fog lamp) 4x M6x16mm screw 4x M6 Flange Nuts</p> <p>2x M8x20mm Button head bolts 2x M8 Flat Washer 2x M8 Flange Nuts</p> <p>Per side</p>



<p>113. Fit light mesh panels to the bar. Position the panel from underneath the bar and align with the mounting holes in the wing. Secure with 4x M6x16mm Button head bolts and M6 Flange Nuts</p> <p>114. Repeat for other side of vehicle.</p> <p>115. Reconnect fog lights, or additional driving lights, depending on what was fitted.</p>	<p>TOOLS REQUIRED 4mm Hex Key 10mm Spanner</p>
	<p>FASTENERS 4x M6x16mm Button head bolt 4x M6 Flange Nut</p>

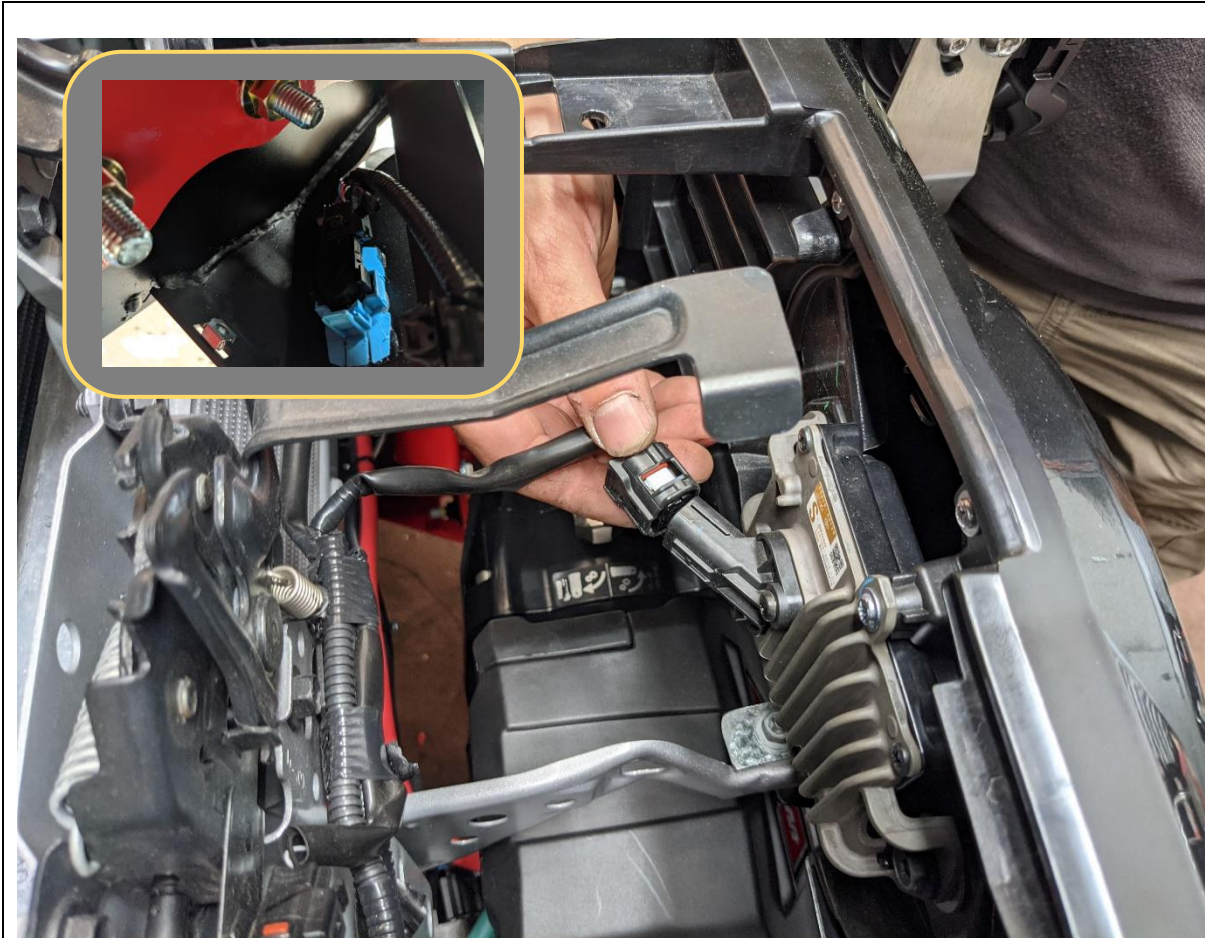

116. Re-connect all wiring harnesses to the adaptive cruise sensor, parking sensors and fog lights

117. Replace the radiator shroud to top of grille, Secure with factory push center clips.

TOOLS REQUIRED

FASTENERS

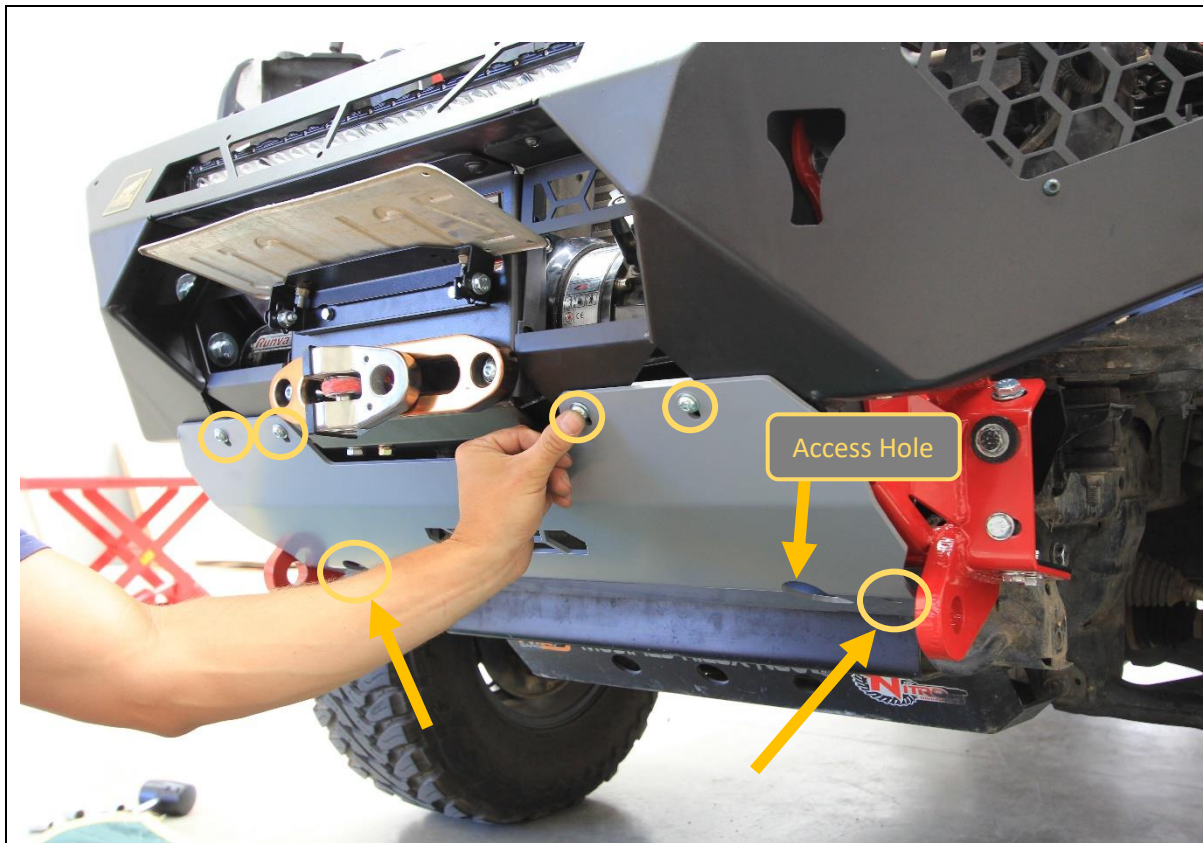

<p>118. Fit bash plate to vehicle.</p>	<p>TOOLS REQUIRED</p> <p>5mm Hex 6mm Hex 13mm Spanner & Socket 15mm Spanner</p>
<p>119. First secure the top of the bash plate to the bottom of bar, through Shim plate, Mesh panel, then bar itself. Secure with M8x20 Button head bolts, Flat washer and Flange Nuts.</p> <p>120. Secure bottom of Bash plate to mounts M10x30mm Button head Bolt, Flat washer and M10 Flange Nut. Insert nut through access hole in bash plate as shown.</p>	
<p>FASTENERS</p> <p>4x M8x20 Button head Bolt 4xM8 Flat washer 2x M8 Flange nut 2x M10x30 Button head Bolt 2x M10 Flat washer 2x M10 Flange nut</p>	

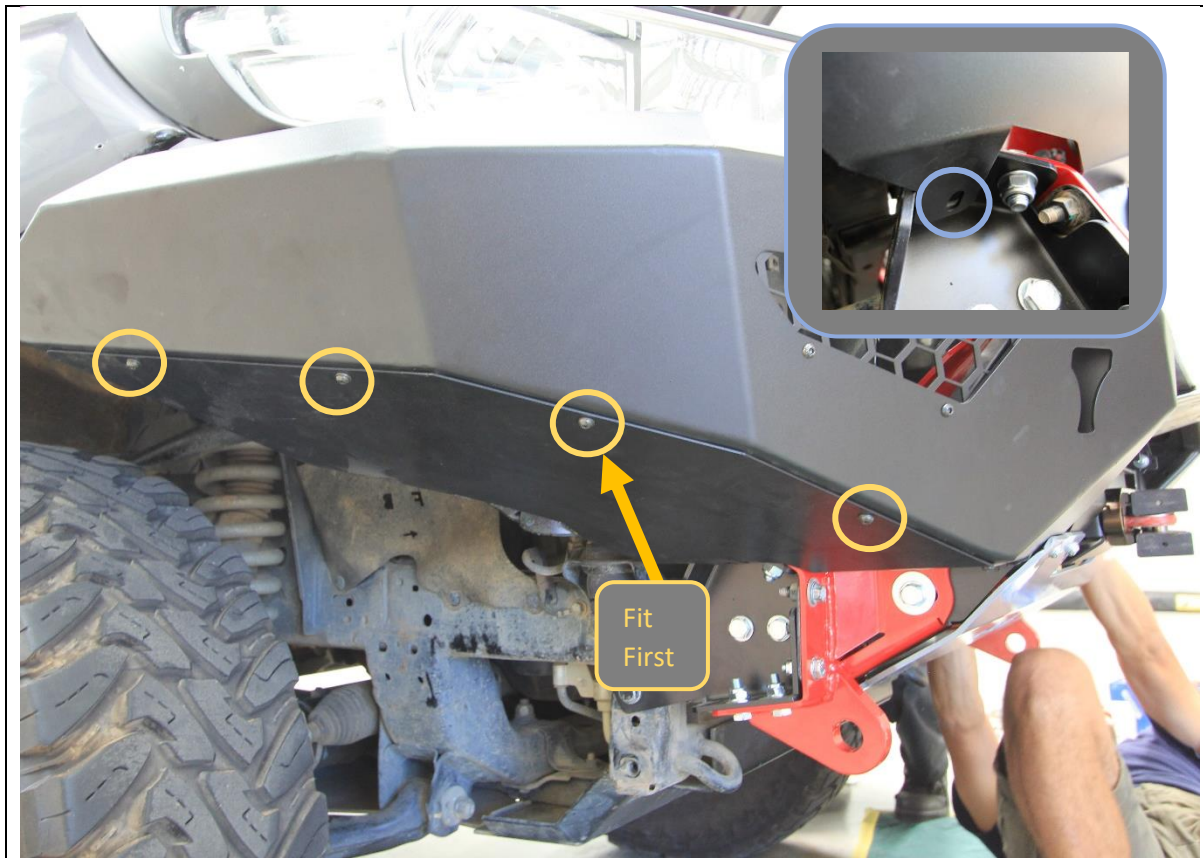

121. Fit side under panels to bar and secure with 4x M6x16 Button head bolts and M6 Flat washers, into M6 cage nuts fitted earlier.

Fitting center bolt first will make it easier to align panel to bar.

122. Secure the back corner of underpanel to mount using M8x20 Hex bolt, Flat washer and M8 Flange Nut.

123. Repeat for other side of vehicle.

TOOLS REQUIRED
4mm Hex Key
13mm Spanner / Socket

FASTENERS
8x M8x20 Button head bolt
8x M6 Flat Washer
2xM8x20 Hex head
2xM8Flat Washer
2x M8 Flange nut



<p>124. Mark where wheel arch liner intersects with side under panel with paint pen or other marker.</p> <p>125. Create line offset approximately 20mm below intersection point.</p> <p>126. Trim wheel arch liner to this line using utility Knife.</p>	<p>TOOLS REQUIRED</p> <p>Marker Utility Knife</p>
<p>127. Insert wheel arch liner behind flange on side under panel.</p>	<p>FASTENERS</p>

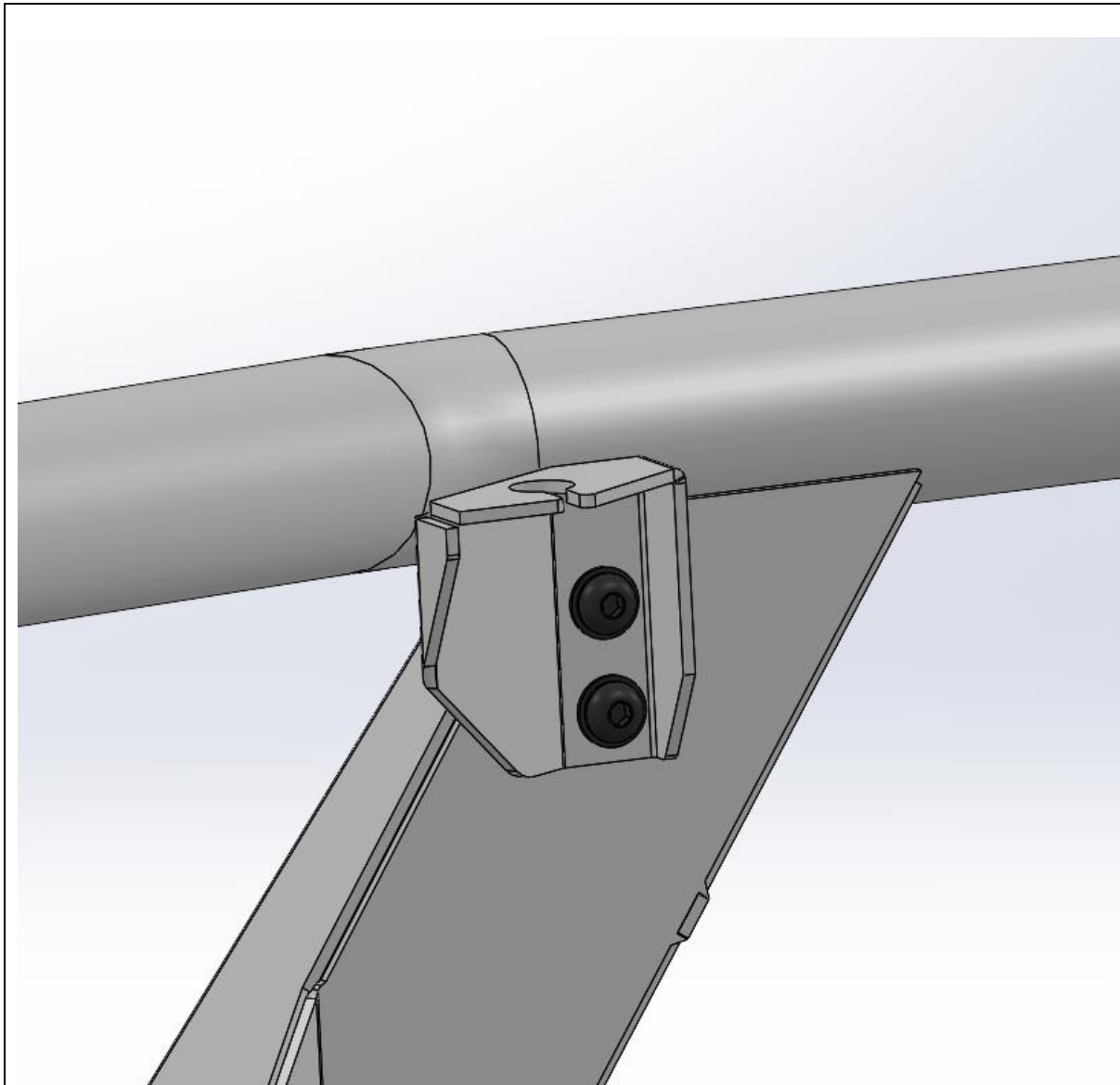

128. For Toro bars, if fitting antenna fit the antenna brackets to the captive nuts in the uprights using supplied M8x20 Button head bolts, and flat washers

Note: Due to close fitting nature of bar Oversized UHF antenna bases are not suitable for fitment.

TOOLS REQUIRED
5mm Hex Key

FASTENERS
2x M8x20 Black Button head
2xM8 Black Flat Washer

Per side



- 129. Fit the logo plate to the front of the bar as shown.
- 130. Fit the Compliance plate in a visible location on the underside of the bar. We recommend placing it on the bottom of the center bash plate.
- 131. Review fitment and double check all bolts are tight.

TOOLS REQUIRED

- Marker
- Utility Knife

FASTENERS



Congratulations!
Head for the tracks and enjoy your newly protected Toyota Hilux!